

Product Catalogue

RESIDENTIAL, COMMERCIAL & GOLF IRRIGATION | Built on Innovation®

VOLUME 40

Hunter®



Table of CONTENTS

● INTRODUCTION

- 4 Partnering for Success
- 6 Advancing the Industry Through Innovation
- 8 Revolutionary Solutions for the Golf Course and Beyond

● ROTORS

- 16 PGJ
- 18 SRM
- 19 PGP-ADJ
- 22 PGP™ Ultra
- 23 I-20
- 24 PGP Ultra PRB
- 24 I-20 PRB
- 28 I-25
- 31 I-40
- 34 I-80
- 36 I-90
- 38 HSJ Swing Joints
- 39 Snaplok™ Combo Kits
- 39 HCV Check Valves

● ST SYSTEMS

- 42 ST-90-B
- 42 High-Flow Swing Joints
- 43 ST-1200-BR
- 44 ST-1600-HS-BR
- 45 ST-1700-V **◆ NEW**
- 46 STG-900-KIT-B/STG-900
- 48 STG-1600-KIT-B/ST-1600-HS-B

● MP ROTATOR™

- 52 Eco-Rotator
- 54 Standard MP Rotator Nozzles
- 58 MP Rotator MP800 Nozzles
- 60 MP Rotator Stake Kit

● SPRAY SPRINKLER BODIES

- 66 PS Ultra
- 69 Pro-Spray™
- 70 Pro-Spray PRS30 **◆ NEW**
- 72 Pro-Spray PRS40 **◆ NEW**

● SPRAY ACCESSORIES

- 74 SJ Swing Joints
- 74 Hunter Spiral Barb Elbows
- 74 FlexSG Tubing
- 74 Pro-Spray Shutoff Cap
- 74 Shutoff Nozzle

● NOZZLES

- 76 Pro High-Efficiency Nozzles **◆ NEW**
- 78 Pro Adjustable Nozzles
- 82 Pro Fixed Nozzles
- 85 Short-Radius Micro Spray Nozzles
- 86 Strip Pattern Nozzles
- 87 Bubbler Nozzles
- 88 Bubblers

● VALVES

- 93 1½" (40 mm) and 2" (50 mm) PGV
- 94 1" (25 mm) PGV
- 96 ICV
- 98 IBV
- 100 Quick Couplers
- 102 Accu Sync™ Pressure Regulators
- 103 DC-Latching Solenoid
- 103 AC Solenoid

● CONTROLLERS

- 106 Controller Selection Guide

● STANDARD CONTROLLERS

- 110 Eco Logic
- 111 X-Core™

● HYDRAWISE™ CONTROLLERS

- 114 Hydrawise Software
- 116 HC
- 117 X2™
- 118 WAND for X2
- 119 Pro-HC
- 120 HPC
- 121 HCC

● CENTRALUS™ CONTROLLERS

- 124 Centralus Software
- 126 ACC2
- 127 ACC2 Decoder
- 128 ICC2
- 130 Pro-C™ **◆ NEW**
- 132 Hunter Field Servers **◆ NEW**

● BATTERY-OPERATED CONTROLLERS

- 134 BTT
- 135 NODE
- 136 NODE-BT **◆ NEW**
- 137 XC Hybrid

● CONTROLLER DECODERS AND ACCESSORIES

- 140 ICD
- 141 ICD-HP Programmer
- 142 EZ Decoder System
- 143 EZ-DT
- 144 Universal Decoder Stake
- 144 Antenna Extension Kits
- 145 Waterproof Wire Connector
- 145 Waterproof Splice Kit
- 146 ROAM Remote
- 147 ROAM XL Remote
- 148 Pump Start Relay (PSR)
- 148 Pump Start Relay Booster (PSR-B)
- 149 Controller Communication Devices **◆ NEW**

● SENSORS

- 154 Rain-Clik™
- 155 Mini-Clik™ **NEW**
- 156 Solar Sync™
- 157 Soil-Clik™
- 158 HC Flow Meter
- 160 Flow-Clik™
- 161 Flow-Sync™
- 162 Wireless Flow Sensor (WFS)

● MICRO

- 165 Micro Irrigation Solutions

● CONTROL ZONE KITS

- 167 PCZ
- 168 Filters and Filter Regulators
- 169 Senninger™ Pressure Regulators

● DRIPLINE SYSTEMS

- 171 HDL-CV
- 172 HDL-PC
- 172 HDL-R
- 173 HDL-BLNK
- 174 HDL-COP **NEW**
- 175 PLD
- 176 PLD Barb Fittings (16 mm)
- 177 PLD LOC Fittings
- 177 PLD Barb Fittings (17 mm)

● SUBSURFACE SYSTEMS

- 179 Eco-Mat™
- 180 Eco-Wrap™
- 181 Eco-Indicator **NEW**
- 182 Supply Tubing
- 182 MLD
- 183 Distribution Tubing
- 183 6 mm Fittings
- 184 RZWS
- 185 RZWS-E

● SOFT AND HARD PIPE SYSTEMS

- 188 Point-Source Emitters
- 189 IH Risers
- 190 Multi-Port Emitters
- 190 Rigid Risers
- 191 Micro Sprays
- 192 Multi-Purpose Box
- 193 Air/Vacuum Relief Valve
- 193 Automatic Flush Valve

● RECLAIMED

- 196 Rotors/Sprinkler Bodies
- 197 Bubblers/Valves/Micro **NEW**

● TOOLS

- 199 SpotShot Hose-End Nozzle
- 199 Pitot Gauge
- 199 MP Gauge Assembly
- 199 Hand Pump
- 199 Nozzle Insertion Collar
- 199 Hunter Wrench
- 199 T-Handle Tool
- 199 Nozzle Removal/Installation Tool
- 199 Snap Ring Removal Tool

● RESOURCES

- 201 Hunter University
- 202 Education, Tools, and Support for Professionals

● TECHNICAL INFORMATION

- 204 Precipitation Rates
- 205 Slope Equivalents/Irrigation
- 206 Height of Spray Charts
- 209 HDL Maximum Run Lengths Charts **NEW**
- 210 MLD Flow Chart **NEW**
- 211 Conversion Factors Chart
- 212 Friction Loss Charts
- 219 Pressure Loss Charts
- 219 Accessory Pressure Loss Charts
- 220 BTT Pressure Loss Charts
- 221 Wire Data Chart
- 221 PSR Wire Data Chart
- 222 Wire Sizing
- 223 Additional Data

● STATEMENT OF WARRANTY

- 226 Statement of Warranty

PARTNERING FOR SUCCESS

Helping You Grow Is Our Mission

At Hunter Industries, our main objective is to deliver the irrigation solutions you need most to grow your business. We're grateful to you, our customers, for your partnership and trust over the past four decades. Your support continues to drive our passion for providing industry-leading products, comprehensive educational programs, and exceptional customer service.

Recent investments in our manufacturing operations have allowed us to expand our production capacities and launch innovative new products that deliver high-level performance, increased water and energy savings, and greater system flexibility — all of which strengthen your business.

Educating your team on our products and industry best practices is key to our mutual success. We've launched many new online courses focusing on irrigation system fundamentals, added time-saving tools to our free business applications, and updated our state-of-the-art customer training center at our corporate headquarters to engage with industry professionals through popular hands-on workshops.

Along with products and education, we continue to invest in the latest technologies that enable us to respond to your needs as quickly as possible. Our world-class customer support and technical support teams are ready to help you the moment you need it.

We're proud to be your partner, and we thank you for choosing Hunter Industries.



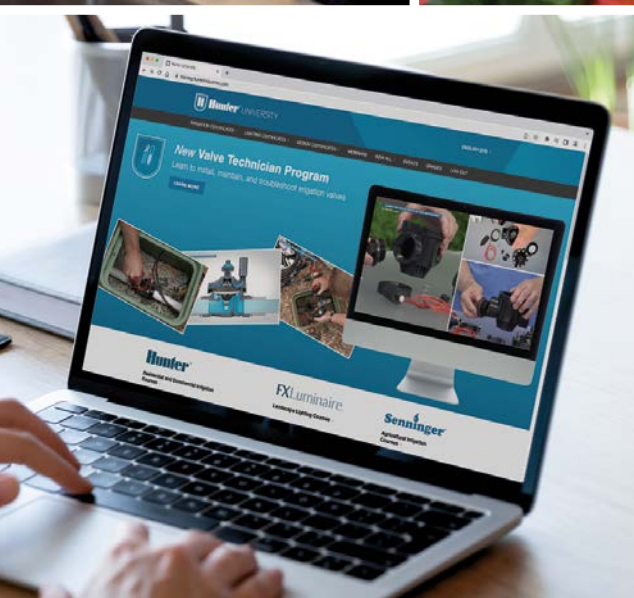

ADVANCING THE INDUSTRY

Through Innovation

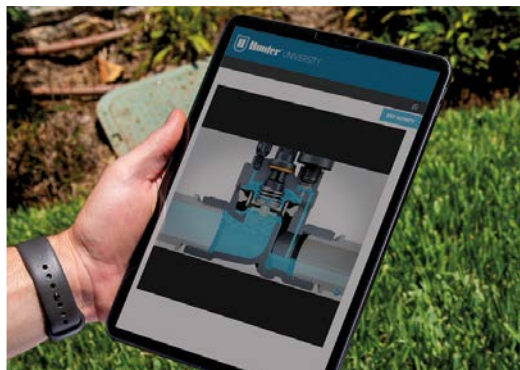
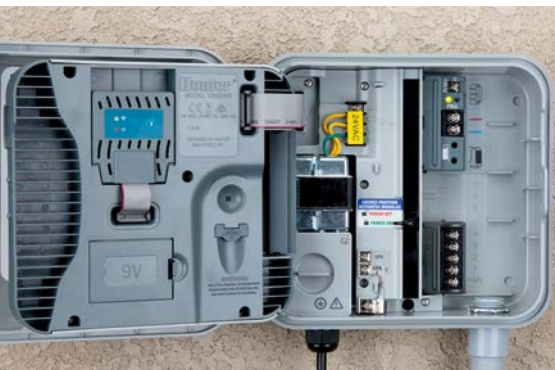

Everything we do at Hunter Industries is rooted in innovation. From small residential installations to fully automated smart cities, our teams continually develop solutions to help you deliver water as efficiently and sustainably as possible.

That's why we're excited to introduce the latest additions to our cutting-edge lineup: revolutionary Pro High-Efficiency Nozzles (page 76) and the updated Pro-C™ Controller (page 130).

As we continue to explore new ways to innovate, you can expect us to deliver even more industry-leading products, services, and tools in the future to help your business grow.



Leading the Way Toward Greater Sustainability

As the industry's sustainability leader, we're committed to supporting and improving the communities where we live, work, and play.

We develop products and technologies that enable the efficient use of our natural resources and reduce our environmental footprint.

We believe in the triple bottom line, which focuses on People, Planet, and Profit.

Scan to learn more about our commitment to sustainability!



REVOLUTIONARY SOLUTIONS

For the Golf Course and Beyond



Österåkers Golfklubb, Sweden

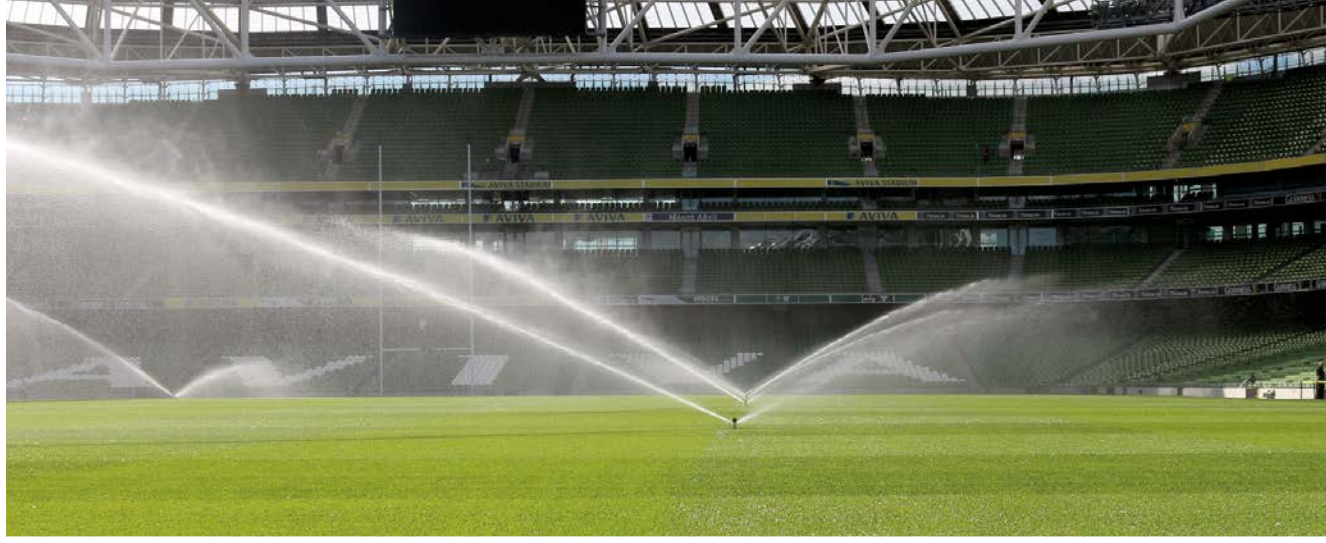

Hunter® | *Golf Irrigation*

Over the last three decades, Hunter Industries has built a long-standing reputation for innovation in the golf industry. We've invested heavily in research and development, resulting in numerous industry-leading golf irrigation solutions. Our latest innovations include the TTS-800 Series Golf Rotors with a large, future-ready flange compartment and Pilot™ Command Center Software with cloud-based features that help you save time, money, and resources.

While our best-in-class irrigation solutions are renowned on the golf course, they also provide unmatched reliability in applications well beyond fairways and greens. When installed around the perimeter of sports fields, our powerful Hunter Golf rotors ensure healthy turf and increased safety for athletes. Featuring the highest torque output gear drives in the industry and exclusive PressurePort™ Nozzle Technology, these rotors set the standard for water efficiency, distribution uniformity, and long-lasting performance.

PRODUCTS THAT EXCEED EXPECTATIONS

On Every Level

Hunter Golf products continually push the boundaries of innovation to deliver solutions that exceed expectations on every level. With premier products like our Pilot™ Command Center Software and TTS-800 Series Golf Rotors, we have the field-proven tools you need to ensure turf is always ready for play — on the golf course or the sports field.

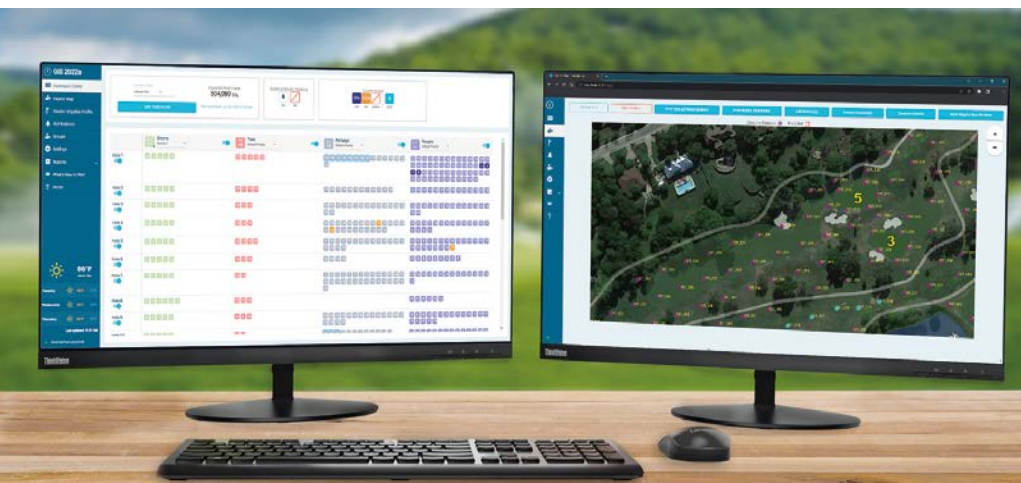

Pilot Command Center Software

Our intuitive and flexible irrigation control software continually monitors your system and updates to ensure the most efficient watering cycles based on your turf's daily needs. Cloud database backups and web-based features provide optimised display and functionality. In addition, POGO® visual insight integrations save time and resources with more informed scheduling adjustments using real-time data. These Pilot Cloud features lay the foundation for the future of golf course irrigation control and create more possibilities for third-party integrations and mobile optimisation.



SCAN TO VIEW THE FULL HUNTER GOLF CATALOG.

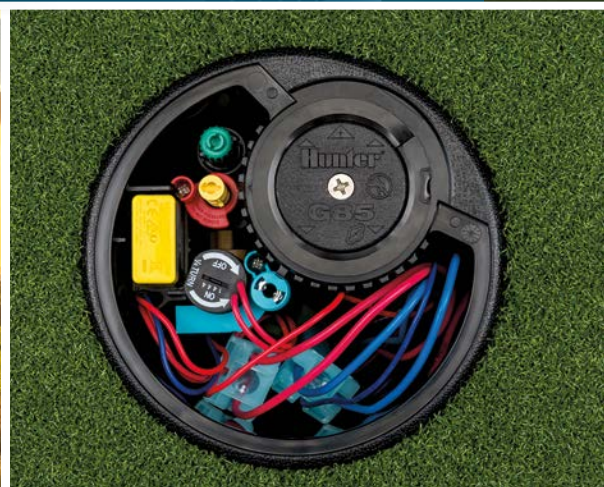

TTS-800 Series Golf Rotors

Maximise performance in the field with our top-of-the-line golf rotors. Combining the industry's strongest, high-torque gear drives with the proprietary Filter Sentry™ Mechanism in the inlet valve, they irrigate efficiently without clogging — especially in harsh water conditions. Exclusive PressurePort™ Nozzle Technology saves water and improves playability by optimising individual nozzle pressures for maximum distribution uniformity. Plus, no-dig Total-Top-Serviceability and the largest flange compartment in the industry make routine maintenance easy, ensuring years of reliable operation.



ROTORS



ROTORS

ADVANCED FEATURES

RELIABLE STRENGTH & DURABILITY

PRESSURE-REGULATED BODY



Reduce high incoming pressure to prevent misting and allow nozzles to operate at peak efficiency. Lower pressure produces larger water droplets that fight the effects of wind.

PGP™ Ultra Shrub and 10 cm, I-20 10 and 15 cm

STAINLESS STEEL RISER



For unforgiving soil conditions, unpredictable climates, or heavy foot traffic, stainless steel is the best choice.

Standard on I-40 and I-80
Optional on I-20 and I-25

DRAIN CHECK VALVE



The Drain Check Valve keeps lines from draining when the system is shut off. This saves water, reduces liability, and prolongs system life.

PGJ, PGP Ultra, I-20, I-25, I-40, I-80, I-90

VALUE-ADDED OPTIONS



OPPOSING NOZZLE 360° MODEL

The opposing nozzle design offers excellent water distribution. With primary and secondary nozzles on opposing sides of the turret, streams arc in opposite directions as the sprinkler rotates for outstanding midrange and close-in watering.

I-40, I-80, I-90

EASY IN-THE-FIELD IDENTIFICATION

OPTIONAL RECLAIMED WATER ID



Purple caps indicate where non-potable irrigation water is being used.

PGJ, PGP Ultra, I-20, I-25, I-40, I-80, I-90

COLOUR-CODED NOZZLES



Nozzles are easier to differentiate in the field for simple installation and quick organisation.

I-25, I-40, I-80, I-90

EASY AS-NEEDED ADJUSTMENTS

AUTOMATIC ARC RETURN & NON-STRIPPABLE DRIVE

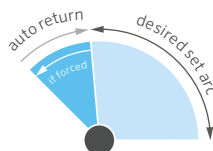

This patented feature returns the turret to the original arc regardless of where it is turned. The non-strippable drive mechanism is protected from damage, ensuring protection from vandalism.

PGP Ultra, I-20, I-25, I-40

FLOSTOP™ CONTROL



FloStop™ Technology stops the flow of water from individual sprinkler heads while the system is running. This is ideal for changing nozzles or turning off specific heads during maintenance and construction.

I-20

HEADED AND SLOTTED SETSCREW



Use a slotted screwdriver or the Hunter Wrench for easier and simpler adjustments as needed.

PGJ, PGP Ultra, I-20

ROTOR COMPARISON CHART

QUICK SPECS		PGJ	SRM	PGP-ADJ	PGP ULTRA	I-20	I-25	I-40	I-40-ON	I-80	I-90
INLET SIZE		½"	½"	¾"	¾"	¾"	1" (25 mm)	1" (25 mm)	1" (25 mm)	1½" (40 mm)	1½" (40 mm)
RADIUS	m	4.3-11.6	4.0-9.4	6.4-15.8	4.9-14.0	4.9-14.0	11.9-21.6	13.1-23.3	15.2-23.2	19.2-29.6	22.3-31.7
FLOW	m³/hr	0.13-1.23	0.08-0.82	0.10-3.22	0.07-3.23	0.07-3.23	0.82-7.24	1.63-6.84	2.75-7.76	4.6-13.5	6.7-19.0
	l/min	2.2-20.5	1.4-13.7	1.7-53.7	1.2-53.8	1.2-53.8	13.6-120.7	27.2-114.1	45.8-129.4	76.5-225.6	111.7-317.2
FEATURES											
RECOMMENDED PRESSURE RANGE	bar	1.7-3.8	1.7-3.8	1.7-4.5	1.7-4.5	1.7-4.5	2.5-7.0	2.5-7.0	2.5-7.0	3.4-6.9	5.5-8.0
	kPa	170-380	170-380	170-450	170-450	170-450	250-700	280-700	280-700	340-690	550-800
OPERATING PRESSURE RANGE	bar	1.4-7.0	1.4-7.0	1.4-7.0	1.4-7.0	1.4-7.0	2.5-7.0	2.5-7.0	2.5-7.0	3.4-6.9	5.0-8.0
	kPa	140-700	140-700	140-700	140-700	140-700	250-700	250-700	250-700	340-690	500-800
NOZZLE TRAJECTORY		15°	15°	25°	25°	25°	25°	25°	25°	25°	22.5°
SPECIFIC NOZZLES		---	---	---	Optional	Optional	Pre-Installed	Pre-Installed	Pre-Installed	Pre-Installed	Pre-Installed
NOZZLE OPTIONS		8	6	27	34	34	11	6	6	21	16
WARRANTY		2 Years	1 Year	2 Years	5 Years	5 Years	5 Years	5 Years	5 Years	5 Years	5 Years
ADVANCED FEATURES											
LOW-ANGLE NOZZLE CHOICES				●	●	●					
AUTOMATIC ARC RETURN					●	●	●	●			
NON-STRIPPABLE DRIVE					●	●	●	●			
PART- AND FULL-CIRCLE IN ONE MODEL					●	●	●	●		●	
HEADED AND SLOTTED SETSCREW		●			●	●					
RECLAIMED WATER ID		●			●	●	●	●	●	●	●
AVAILABLE SHORT RADIUS NOZZLES					●	●					
FLOSTOP™ CONTROL						●					
OPPOSING NOZZLE									●	●	●
STAINLESS STEEL RISER OPTION						●	●	●	●	●	
OPTIONAL PRESSURE-REGULATED BODY					●	●					
OPTIONAL OR FACTORY-INSTALLED DRAIN CHECK VALVE		● (2 m)			● (3 m)	● (3 m)	● (3 m)	● (4.5 m)	● (4.5 m)	● (1.5 m)	● (2 m)

PGJ

Radius: **4.0 to 10.7 m**
Flow: **0.08 to 1.0 m³/hr; 1.4 to 16.7 l/min**

The highly durable PGJ offers all the benefits of a large rotor in a compact, spray-sized package, with water-efficient nozzles and easy arc adjustment.

KEY BENEFITS

- Headed and slotted setscrew allows radius adjustment with a Hunter Wrench or flat-blade screwdriver
- Adjustable arc from 40° to 360° to keep water in the appropriate areas
- Standard factory-installed 2.0 nozzle speeds installation
- QuickCheck™ Arc Mechanism for fast arc adjustment

OPERATING SPECIFICATIONS

- Nozzle choices: 8
- Radius: 4.0 to 10.7 m
- Flow: 0.08 to 1.0 m³/hr; 1.4 to 16.7 l/min
- Recommended pressure range: 1.7 to 3.8 bar; 170 to 380 kPa
- Operating pressure range: 1.4 to 7.0 bar; 140 to 700 kPa
- Precipitation rate: 15 mm/hr approximately
- Nozzle trajectory: 15° approximately
- Warranty period: 2 years

FACTORY-INSTALLED OPTIONS

- Drain Check Valve (up to 2.1 m of elevation) excluding PGJ-00
- Reclaimed water ID

USER-INSTALLED OPTIONS

- Drain Check Valve (up to 2.1 m of elevation) excluding PGJ-00 (P/N 462078SP)
- HC-50F-50M Check Valve (up to 9.7 m of elevation)



PGJ Reclaimed

Available as a factory-installed option on all models

PGJ - SPECIFICATION BUILDER: ORDER 1 + 2 + 3

1 Model	2 Standard Features	3 Feature Options
PGJ-00 = Shrub	Adjustable arc, 8 standard nozzles	(blank) = No option
PGJ-04 = 10 cm pop-up		V = Drain Check Valve
PGJ-06 = 15 cm pop-up		R = Drain Check Valve and reclaimed water ID (pop-up models only)
PGJ-12 = 30 cm pop-up		

Examples:

PGJ-04 = 10 cm pop-up, adjustable arc

PGJ-06 -V = 15 cm pop-up, adjustable arc, with Drain Check Valve

PGJ-12 -R = 30 cm pop-up, adjustable arc, with Drain Check Valve and reclaimed water ID



PGJ-00

Overall height: 18 cm
Exposed diameter: 3 cm
Inlet size: ½"



PGJ-04

Overall height: 18 cm
Pop-up height: 10 cm
Exposed diameter: 3 cm
Inlet size: ½"



PGJ-06

Overall height: 23 cm
Pop-up height: 15 cm
Exposed diameter: 3 cm
Inlet size: ½"



PGJ-12

Overall height: 41 cm
Pop-up height: 30 cm
Exposed diameter: 3 cm
Inlet size: ½"

PGJ PERFORMANCE DATA							
Nozzle	Pressure		Radius m	Flow		Precip mm/hr	
	bar	kPa		m ³ /hr	l/min	■	▲
0.50	1.7	170	4.3	0.08	1.4	9	11
	2.0	200	4.3	0.09	1.6	10	12
	2.5	250	4.6	0.11	1.8	10	12
	3.0	300	4.6	0.12	2.0	12	13
	3.5	350	4.9	0.13	2.2	11	13
	3.8	380	4.9	0.14	2.3	12	14
0.75	1.7	170	4.3	0.13	2.2	14	17
	2.0	200	4.6	0.14	2.4	14	16
	2.5	250	4.9	0.16	2.7	13	15
	3.0	300	5.2	0.18	3.0	13	15
	3.5	350	5.2	0.19	3.2	14	17
	3.8	380	5.5	0.20	3.4	13	15
1.0	1.7	170	5.2	0.18	3.0	13	15
	2.0	200	5.5	0.19	3.2	13	15
	2.5	250	5.5	0.21	3.5	14	16
	3.0	300	5.8	0.23	3.8	14	16
	3.5	350	5.8	0.24	4.1	15	17
	3.8	380	6.1	0.25	4.2	14	16
1.5	1.7	170	6.1	0.27	4.5	15	17
	2.0	200	6.4	0.29	4.8	14	16
	2.5	250	6.4	0.32	5.4	16	18
	3.0	300	6.7	0.36	6.0	16	18
	3.5	350	6.7	0.39	6.4	17	20
	3.8	380	7.0	0.40	6.7	16	19
2.0	1.7	170	7.0	0.34	5.6	14	16
	2.0	200	7.3	0.37	6.2	14	16
	2.5	250	7.3	0.42	7.1	16	18
	3.0	300	7.6	0.48	8.0	17	19
	3.5	350	7.6	0.53	8.8	18	21
	3.8	380	7.9	0.56	9.3	18	20
2.5	1.7	170	7.9	0.46	7.6	15	17
	2.0	200	8.2	0.49	8.1	14	17
	2.5	250	8.2	0.54	9.0	16	18
	3.0	300	8.5	0.59	9.8	16	19
	3.5	350	8.5	0.63	10.5	17	20
	3.8	380	8.8	0.65	10.9	17	19
3.0	1.7	170	8.8	0.51	8.5	13	15
	2.0	200	9.1	0.56	9.3	13	15
	2.5	250	9.1	0.64	10.6	15	18
	3.0	300	9.4	0.72	12.0	16	19
	3.5	350	9.4	0.78	13.1	18	20
	3.8	380	9.8	0.82	13.7	17	20
4.0	1.7	170	9.8	0.80	13.3	17	19
	2.0	200	10.1	0.83	13.8	16	19
	2.5	250	10.1	0.89	14.8	18	20
	3.0	300	10.4	0.94	15.7	17	20
	3.5	350	10.4	0.98	16.3	18	21
	3.8	380	10.7	1.00	16.7	18	20

Note:

All precipitation rates are calculated for 180° operation. For the precipitation rate of a 360° sprinkler, divide by 2.

PGJ NOZZLES

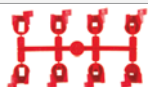

PGJ



Compatible with:

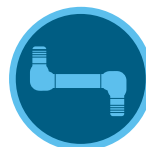

SJ Swing Joints
Page 74

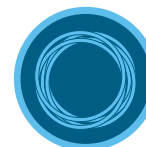

Hunter FlexSG
Page 74

SRM

The SRM is an economical short-range rotor that offers a convenient and efficient alternative to spray heads.

Radius: **4.0 to 10.7 m**
Flow: **0.08 to 1.0 m³/hr; 1.4 to 16.7 l/min**

ROTORS

KEY BENEFITS

- Adjustable arc from 40° to 360° to keep water in the appropriate areas
- Standard factory-installed 2.0 nozzle speeds installation
- QuickCheck™ Arc Mechanism for fast arc adjustment

OPERATING SPECIFICATIONS

- Nozzle choices: 8
- Radius: 4.0 to 10.7 m
- Flow: 0.08 to 1.0 m³/hr; 1.4 to 16.7 l/min
- Recommended pressure range: 1.7 to 3.8 bar; 170 to 380 kPa
- Operating pressure range: 1.4 to 7.0 bar; 140 to 700 kPa
- Precipitation rate: 11 mm/hr approximately
- Nozzle trajectory: 14° approximately
- Warranty period: 1 year

USER-INSTALLED OPTIONS

- Drain Check Valve (up to 2.1 m of elevation) (P/N 462078SP)

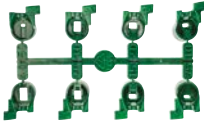
SRM		SRM NOZZLES
Model	Description	
SRM-04	10 cm pop-up, adjustable arc, 8 standard nozzles	



SRM-04

Overall height: 17 cm
Pop-up height: 10 cm
Exposed diameter: 3 cm
Inlet size: ½"

SRM-04 PERFORMANCE DATA

Nozzle	Pressure		Radius m	Flow		Precip in/hr	
	bar	kPa		m ³ /hr	l/min		
0.50	1.7	170	4.3	0.08	1.4	9	11
	2.0	200	4.3	0.09	1.6	10	12
	2.5	250	4.6	0.11	1.8	10	12
	3.0	300	4.6	0.12	2.0	12	13
	3.5	350	4.9	0.13	2.2	11	13
	3.8	380	4.9	0.14	2.3	12	14
0.75	1.7	170	4.3	0.13	2.2	14	17
	2.0	200	4.6	0.14	2.4	14	16
	2.5	250	4.9	0.16	2.7	13	15
	3.0	300	5.2	0.18	3.0	13	15
	3.5	350	5.2	0.19	3.2	14	17
	3.8	380	5.5	0.20	3.4	13	15
1.0	1.7	170	5.2	0.18	3.0	13	15
	2.0	200	5.5	0.19	3.2	13	15
	2.5	250	5.5	0.21	3.5	14	16
	3.0	300	5.8	0.23	3.8	14	16
	3.5	350	5.8	0.24	4.1	15	17
	3.8	380	6.1	0.25	4.2	14	16
1.5	1.7	170	6.1	0.27	4.5	15	17
	2.0	200	6.4	0.29	4.8	14	16
	2.5	250	6.4	0.32	5.4	16	18
	3.0	300	6.7	0.36	6.0	16	18
	3.5	350	6.7	0.39	6.4	17	20
	3.8	380	7.0	0.40	6.7	16	19
2.0	1.7	170	7.0	0.34	5.6	14	16
	2.0	200	7.3	0.37	6.2	14	16
	2.5	250	7.3	0.42	7.1	16	18
	3.0	300	7.6	0.48	8.0	17	19
	3.5	350	7.6	0.53	8.8	18	21
	3.8	380	7.9	0.56	9.3	18	20
2.5	1.7	170	7.9	0.46	7.6	15	17
	2.0	200	8.2	0.49	8.1	14	17
	2.5	250	8.2	0.54	9.0	16	18
	3.0	300	8.5	0.59	9.8	16	19
	3.5	350	8.5	0.63	10.5	17	20
	3.8	380	8.8	0.65	10.9	17	19
3.0	1.7	170	8.8	0.51	8.5	13	15
	2.0	200	9.1	0.56	9.3	13	15
	2.5	250	9.1	0.64	10.6	15	18
	3.0	300	9.4	0.72	12.0	16	19
	3.5	350	9.4	0.78	13.1	18	20
	3.8	380	9.8	0.82	13.7	17	20
4.0	1.7	170	9.8	0.80	13.3	17	19
	2.0	200	10.1	0.83	13.8	16	19
	2.5	250	10.1	0.89	14.8	18	20
	3.0	300	10.4	0.94	15.7	17	20
	3.5	350	10.4	0.98	16.3	18	21
	3.8	380	10.7	1.00	16.7	18	20

Note:

All precipitation rates are calculated for 180° operation. For the precipitation rate of a 360° sprinkler, divide by 2.

SRM



Compatible with:



SJ Swing Joints
Page 74



Hunter FlexSG
Page 74

PGP-ADJ

Radius: **6.4 to 15.8 m**
Flow: **0.10 to 3.22 m³/hr; 1.7 to 53.7 l/min**

As Hunter's original rotor, the PGP-ADJ delivers unsurpassed reliability, durability, versatility, and value, keeping it the professional's choice year after year.

KEY BENEFITS

- Three types of nozzles available for various landscapes: red standard, blue standard, grey low-angle
- Adjustable arc from 40° to 360° to keep water in the appropriate areas
- Factory-installed rubber cover for safety
- Through-the-top arc adjustment for easy installation
- QuickCheck™ Arc Mechanism for fast arc adjustment

OPERATING SPECIFICATIONS

- Nozzle choices: 27
- Radius: 6.4 to 15.8 m
- Flow: 0.10 to 3.22 m³/hr; 1.7 to 53.7 l/min
- Recommended pressure range: 1.7 to 4.5 bar; 170 to 450 kPa
- Operating pressure range: 1.4 to 7.0 bar; 140 to 700 kPa
- Precipitation rate: 10 mm/hr approximately
- Nozzle trajectory: standard = 25°, low-angle = 13°
- Warranty period: 2 years

FACTORY-INSTALLED OPTIONS

- Red 5 to 8 Nozzles, Blue 1.5 to 4.0 Nozzles

USER-INSTALLED OPTIONS

- Drain Check Valve (up to 1 m of elevation) P/N 142300SP



PGP-ADJ

Overall height: 19 cm
Pop-up height: 10 cm
Exposed diameter: 4 cm
Inlet size: 3/4"



PGP-ADJ

Easy arc and radius adjustment

PGP-ADJ - SPECIFICATION BUILDER: ORDER 1 + 2 + 3

1 Model	2 Standard Features	3 Feature Options
PGP-ADJ-B = 10 cm pop-up	Adjustable arc with blue nozzle rack	1.5 to 4.0 = Factory-installed blue nozzle number
PGP-ADJ = 10 cm pop-up	Adjustable arc with red nozzle rack	5 to 8 = Factory-installed red nozzle number

Examples:

- PGP-ADJ = 10 cm pop-up, adjustable arc
- PGP-ADJ-B-3.0 = 10 cm pop-up, adjustable arc, and Blue 3.0 Nozzle
- PGP-ADJ-07 = 10 cm pop-up, adjustable arc, and Red 7 Nozzle

PGP-ADJ Red Nozzle



PGP-ADJ-B BLUE NOZZLE PERFORMANCE DATA

Nozzle	Pressure		Radius m	Flow		Precip mm/hr	
	bar	kPa		m ³ /hr	l/min	■	▲
1.5 Blue	1.7	170	8.8	0.27	4.5	7	8
	2.0	200	9.1	0.29	4.8	7	8
	2.5	250	9.4	0.32	5.4	7	8
	3.0	300	9.8	0.35	5.9	7	9
	3.5	350	9.8	0.38	6.4	8	9
	4.0	400	9.8	0.41	6.8	9	10
4.5	450	9.4	0.53	7.2	10	11	
2.0 Blue	1.7	170	10.1	0.32	5.4	6	7
	2.0	200	10.1	0.35	5.8	7	8
	2.5	250	10.1	0.39	6.5	8	9
	3.0	300	10.4	0.43	7.2	8	9
	3.5	350	10.4	0.47	7.8	9	10
	4.0	400	10.4	0.50	8.3	9	11
4.5	450	10.4	0.53	8.8	10	11	
2.5 Blue	1.7	170	10.1	0.39	6.6	8	9
	2.0	200	10.4	0.43	7.1	8	9
	2.5	250	10.7	0.48	8.0	8	10
	3.0	300	10.7	0.54	8.9	9	11
	3.5	350	10.7	0.58	9.7	10	12
	4.0	400	10.7	0.62	10.4	11	13
4.5	450	10.7	0.66	11.1	12	13	
3.0 Blue	1.7	170	10.7	0.50	8.4	9	10
	2.0	200	10.7	0.54	9.1	10	11
	2.5	250	11.0	0.61	10.2	10	12
	3.0	300	11.6	0.68	11.4	10	12
	3.5	350	11.9	0.74	12.3	10	12
	4.0	400	11.9	0.79	13.2	11	13
4.5	450	11.9	0.84	14.0	12	14	
4.0 Blue	1.7	170	11.3	0.68	11.3	11	12
	2.0	200	11.6	0.73	12.2	11	13
	2.5	250	11.9	0.81	13.6	12	13
	3.0	300	12.2	0.90	15.0	12	14
	3.5	350	12.2	0.97	16.2	13	15
	4.0	400	12.5	1.04	17.3	13	15
4.5	450	12.5	1.10	18.3	14	16	
5.0 Blue	1.7	170	11.3	0.84	14.0	13	15
	2.0	200	11.6	0.91	15.2	14	16
	2.5	250	11.9	1.02	17.1	15	17
	3.0	300	12.8	1.14	19.0	14	16
	3.5	350	12.8	1.24	20.6	15	17
	4.0	400	12.8	1.32	22.1	16	19
4.5	450	12.8	1.41	23.4	17	20	
6.0 Blue	1.7	170	11.6	1.01	16.8	15	17
	2.0	200	11.9	1.09	18.2	15	18
	2.5	250	12.2	1.22	20.4	16	19
	3.0	300	13.1	1.36	22.7	16	18
	3.5	350	13.1	1.47	24.5	17	20
	4.0	400	13.4	1.57	26.2	18	20
4.5	450	13.4	1.67	27.9	19	21	
8.0 Blue	1.7	170	11.3	1.35	22.5	21	25
	2.0	200	11.9	1.46	24.3	21	24
	2.5	250	12.5	1.63	27.2	21	24
	3.0	300	13.4	1.81	30.2	20	23
	3.5	350	13.7	1.95	32.6	21	24
	4.0	400	14.0	2.09	34.8	21	25
4.5	450	14.0	2.22	36.9	23	26	

Note:
All precipitation rates are calculated for 180° operation. For the precipitation rate of a 360° sprinkler, divide by 2.

PGP-ADJ GREY LOW-ANGLE NOZZLE PERFORMANCE DATA

Nozzle	Pressure		Radius m	Flow		Precip mm/hr	
	bar	kPa		m ³ /hr	l/min	■	▲
4 LA Grey	1.7	170	6.4	0.30	4.9	14	17
	2.0	200	6.7	0.32	5.3	14	16
	2.5	250	7.0	0.35	5.9	14	17
	3.0	300	7.3	0.39	6.5	15	17
	3.5	350	7.9	0.42	7.0	13	15
	4.0	400	8.5	0.45	7.5	12	14
4.5	450	8.5	0.47	7.9	13	15	
5 LA Grey	1.7	170	7.3	0.33	5.6	12	14
	2.0	200	7.6	0.36	6.0	12	14
	2.5	250	7.9	0.40	6.7	13	15
	3.0	300	8.2	0.45	7.4	13	15
	3.5	350	8.5	0.48	8.0	13	15
	4.0	400	8.8	0.52	8.6	13	15
4.5	450	9.1	0.55	9.1	13	15	
6 LA Grey	1.7	170	8.8	0.44	7.3	11	13
	2.0	200	9.1	0.47	7.9	11	13
	2.5	250	9.4	0.53	8.8	12	14
	3.0	300	9.8	0.59	9.8	12	14
	3.5	350	10.1	0.64	10.6	13	15
	4.0	400	10.7	0.68	11.3	12	14
4.5	450	10.7	0.72	12.0	13	15	
7 LA Grey	1.7	170	8.5	0.58	9.7	16	18
	2.0	200	8.8	0.62	10.3	16	18
	2.5	250	9.4	0.68	11.4	15	18
	3.0	300	10.1	0.75	12.5	15	17
	3.5	350	10.7	0.80	13.3	14	16
	4.0	400	11.3	0.85	14.1	13	15
4.5	450	11.3	0.89	14.8	14	16	
8 LA Grey	1.7	170	9.1	0.71	11.8	17	20
	2.0	200	9.4	0.76	12.7	17	20
	2.5	250	9.8	0.84	14.1	18	20
	3.0	300	10.4	0.93	15.5	17	20
	3.5	350	11.3	1.00	16.6	16	18
	4.0	400	11.6	1.06	17.6	16	18
4.5	450	11.6	1.12	18.6	17	19	
9 LA Grey	1.7	170	9.8	0.89	14.9	19	22
	2.0	200	10.1	0.96	16.0	19	22
	2.5	250	10.7	1.07	17.9	19	22
	3.0	300	11.3	1.19	19.8	19	22
	3.5	350	12.2	1.28	21.3	17	20
	4.0	400	12.8	1.37	22.8	17	19
4.5	450	12.8	1.45	24.1	18	20	
10 LA Grey	1.7	170	10.1	1.17	19.5	23	27
	2.0	200	10.7	1.26	21.0	22	26
	2.5	250	11.3	1.40	23.4	22	25
	3.0	300	11.6	1.55	25.9	23	27
	3.5	350	12.2	1.67	27.8	22	26
	4.0	400	12.8	1.78	29.7	22	25
4.5	450	12.8	1.89	31.4	23	27	

Note:
All precipitation rates are calculated for 180° operation. For the precipitation rate of a 360° sprinkler, divide by 2.

PGP-ADJ NOZZLES



Blue
(P/N 665300)



Grey
(P/N 233200)



PGP-ADJ RED NOZZLE PERFORMANCE DATA							
Nozzle	Pressure		Radius m	Flow		Precip mm/hr	
	bar	kPa		m ³ /hr	l/min	■	▲
1 Red	1.7	170	8.2	0.10	1.7	3	3
	2.0	200	8.5	0.11	1.8	3	3
	2.5	250	8.5	0.13	2.1	4	4
	3.0	300	8.8	0.15	2.4	4	4
	3.5	350	8.8	0.16	2.7	4	5
	4.0	400	9.1	0.18	2.9	4	5
2 Red	4.5	450	9.1	0.19	3.2	5	5
	1.7	170	8.5	0.14	2.4	4	5
	2.0	200	8.8	0.16	2.6	4	5
	2.5	250	8.8	0.17	2.9	4	5
	3.0	300	9.1	0.19	3.2	5	5
	3.5	350	9.1	0.21	3.5	5	6
3 Red	4.0	400	9.4	0.22	3.7	5	6
	4.5	450	9.4	0.23	3.9	5	6
	1.7	170	8.8	0.18	3.0	5	5
	2.0	200	9.1	0.20	3.3	5	5
	2.5	250	9.1	0.22	3.7	5	6
	3.0	300	9.4	0.25	4.1	6	6
4 Red	3.5	350	9.4	0.27	4.5	6	7
	4.0	400	9.8	0.29	4.8	6	7
	4.5	450	9.8	0.31	5.1	6	7
	1.7	170	9.4	0.24	4.1	5	6
	2.0	200	9.8	0.27	4.4	6	6
	2.5	250	9.8	0.30	5.0	6	7
5 Red	3.0	300	10.1	0.34	5.6	7	8
	3.5	350	10.1	0.37	6.2	7	8
	4.0	400	10.4	0.40	6.6	7	9
	4.5	450	10.4	0.43	7.1	8	9
	1.7	170	10.1	0.33	5.5	7	8
	2.0	200	10.4	0.36	5.9	7	8
6 Red	2.5	250	10.4	0.39	6.5	7	8
	3.0	300	11.0	0.43	7.2	7	8
	3.5	350	11.6	0.46	7.7	7	8
	4.0	400	11.6	0.49	8.1	7	8
	4.5	450	11.6	0.51	8.6	8	9
	1.7	170	10.1	0.42	6.9	8	10
7 Red	2.0	200	10.4	0.45	7.5	8	10
	2.5	250	10.7	0.51	8.5	9	10
	3.0	300	11.0	0.57	9.4	9	11
	3.5	350	11.6	0.61	10.2	9	11
	4.0	400	11.6	0.66	10.9	10	11
	4.5	450	11.9	0.70	11.6	10	11
8 Red	1.7	170	10.1	0.54	9.0	11	12
	2.0	200	10.4	0.58	9.7	11	12
	2.5	250	11.0	0.65	10.8	11	12
	3.0	300	11.6	0.72	12.0	11	12
	3.5	350	12.2	0.78	12.9	10	12
	4.0	400	12.2	0.83	13.8	11	13
9 Red	4.5	450	12.2	0.88	14.6	12	14
	1.7	170	11.0	0.66	11.0	11	13
	2.0	200	11.3	0.71	11.8	11	13
	2.5	250	11.6	0.79	13.2	12	14
	3.0	300	11.9	0.87	14.5	12	14
	3.5	350	12.5	0.94	15.6	12	14
10 Red	4.0	400	12.5	1.00	16.6	13	15
	4.5	450	12.8	1.05	17.6	13	15
	1.7	170	11.3	0.73	12.2	11	13
	2.0	200	11.6	0.80	13.4	12	14
	2.5	250	11.6	0.92	15.4	14	16
	3.0	300	12.5	1.05	17.5	13	16
11 Red	3.5	350	13.4	1.15	19.2	13	15
	4.0	400	13.4	1.25	20.9	14	16
	4.5	450	13.7	1.35	22.4	14	17
	2.0	200	12.2	1.14	19.0	15	18
	2.5	250	12.8	1.29	21.4	16	18
	3.0	300	13.4	1.44	24.0	16	18
12 Red	3.5	350	14.0	1.56	26.1	16	18
	4.0	400	14.3	1.68	28.0	16	19
	4.5	450	14.3	1.79	29.9	17	20
	5.0	500	14.6	1.90	31.7	18	21
	2.0	200	12.8	1.55	25.9	19	22
	2.5	250	13.7	1.73	28.7	18	21
13 Red	3.0	300	14.0	1.90	31.7	19	22
	3.5	350	14.6	2.05	34.1	19	22
	4.0	400	14.9	2.18	36.3	20	23
	4.5	450	15.2	2.30	38.4	20	23
	5.0	500	15.5	2.42	40.4	20	23
	2.0	200	12.8	2.03	33.8	25	29
14 Red	2.5	250	13.4	2.26	37.7	25	29
	3.0	300	14.3	2.51	41.8	24	28
	3.5	350	14.6	2.70	45.0	25	29
	4.0	400	14.9	2.88	48.1	26	30
	4.5	450	15.2	3.06	50.9	26	30
	5.0	500	15.8	3.22	53.7	26	30

PGP-ADJ RED NOZZLE PERFORMANCE DATA							
Nozzle	Pressure		Radius m	Flow		Precip mm/hr	
	bar	kPa		m ³ /hr	l/min	■	▲
8 Red	1.7	170	11.0	0.66	11.0	11	13
	2.0	200	11.3	0.71	11.8	11	13
	2.5	250	11.6	0.79	13.2	12	14
	3.0	300	11.9	0.87	14.5	12	14
	3.5	350	12.5	0.94	15.6	12	14
	4.0	400	12.5	1.00	16.6	13	15
9 Red	4.5	450	12.8	1.05	17.6	13	15
	1.7	170	11.3	0.73	12.2	11	13
	2.0	200	11.6	0.80	13.4	12	14
	2.5	250	11.6	0.92	15.4	14	16
	3.0	300	12.5	1.05	17.5	13	16
	3.5	350	13.4	1.15	19.2	13	15
10 Red	4.0	400	13.4	1.25	20.9	14	16
	4.5	450	13.7	1.35	22.4	14	17
	2.0	200	12.2	1.14	19.0	15	18
	2.5	250	12.8	1.29	21.4	16	18
	3.0	300	13.4	1.44	24.0	16	18
	3.5	350	14.0	1.56	26.1	16	18
11 Red	4.0	400	14.3	1.68	28.0	16	19
	4.5	450	14.3	1.79	29.9	17	20
	5.0	500	14.6	1.90	31.7	18	21
	2.0	200	12.8	1.55	25.9	19	22
	2.5	250	13.7	1.73	28.7	18	21
	3.0	300	14.0	1.90	31.7	19	22
12 Red	3.5	350	14.6	2.05	34.1	19	22
	4.0	400	14.9	2.18	36.3	20	23
	4.5	450	15.2	2.30	38.4	20	23
	5.0	500	15.5	2.42	40.4	20	23
	2.0	200	12.8	2.03	33.8	25	29
	2.5	250	13.4	2.26	37.7	25	29
13 Red	3.0	300	14.3	2.51	41.8	24	28
	3.5	350	14.6	2.70	45.0	25	29
	4.0	400	14.9	2.88	48.1	26	30
	4.5	450	15.2	3.06	50.9	26	30
	5.0	500	15.8	3.22	53.7	26	30

Note:
All precipitation rates are calculated for 180° operation. For the precipitation rate of a 360° sprinkler, divide by 2.



PGP™ ULTRA

Radius: **4.9 to 14.0 m**
Flow: **0.07 to 3.23 m³/hr; 1.2 to 53.8 l/min**

The PGP Ultra raises the bar for rotor technology with powerful features developed over three decades of research, customer feedback, and lab testing.

KEY BENEFITS

- Patented automatic arc return feature returns the turret back to the original arc pattern if vandalised; adjustable arc from 50° to 360°
- Non-strippable drive mechanism is protected from damage if turned in the opposite direction of travel
- Part- and full-circle in one model for flexibility across landscapes and reduced inventory
- Headed and slotted setscrew allows radius adjustment with a Hunter Wrench or flat-blade screwdriver
- Flat-top nozzles allow fast, easy insertion
- QuickCheck™ Arc Mechanism for fast arc adjustment

OPERATING SPECIFICATIONS

- Nozzle choices: 34
- Radius: 4.9 to 14.0 m
- Flow: 0.07 to 3.23 m³/hr; 1.2 to 53.8 l/min
- Recommended pressure range: 1.7 to 4.5 bar; 170 to 450 kPa
- Operating pressure range: 1.4 to 7.0 bar; 140 to 700 kPa
- Precipitation rate: 10 mm/hr approximately
- Nozzle trajectory: standard = 25°, low-angle = 13°
- Nozzle racks: Blue 1.5 to 8.0, Grey Low-Angle 2.0 to 4.5, Black 0.50 to 3.0, Green 6.0 to 13.0, MPR-25, MPR-30, MPR-35
- Warranty period: 5 years

FACTORY-INSTALLED OPTIONS

- Drain Check Valve (up to 3 m of elevation)
- Reclaimed water ID
- Blue 1.5-4.0 Nozzles

USER-INSTALLED OPTIONS

- Drain Check Valve (up to 1 m of elevation) PGP-04 only (P/N 142300SP)
- HSJ-0 prefabricated 3/4" PVC Swing Joint



PGP Ultra Reclaimed

Available as a factory-installed option on all models



PGP Ultra

Easy arc and radius adjustment



PGP-00

Overall height: 19 cm
Exposed diameter: 4.5 cm
Inlet size: 3/4"



PGP-04

Overall height: 19 cm
Pop-up height: 10 cm
Exposed diameter: 4.5 cm
Inlet size: 3/4"



PGP-06

Overall height: 25 cm
Pop-up height: 15 cm
Exposed diameter: 4.5 cm
Inlet size: 3/4"



PGP-12

Overall height: 43 cm
Pop-up height: 30 cm
Exposed diameter: 4.5 cm
Inlet size: 3/4"

PGP-ULTRA – SPECIFICATION BUILDER: ORDER 1 + 2 + 3 + 4

1 Model	2 Standard Features	3 Feature Options	4 Nozzle Options
PGP-00 = Shrub PGP-04 = 10 cm pop-up	Adjustable arc, plastic riser, 8 standard nozzles, and 4 low-angle nozzles	CV = Drain Check Valve	Blue 1.5-8.0 Grey low-angle Black short-radius Green high-flow MPR-25-Q, T, H, F MPR-30-Q, T, H, F MPR-35-Q, T, H, F 1.5 to 4.0 = Only nozzles 1.5-4.0 can be factory-installed
PGP-06 = 15 cm pop-up		CV-R = Drain Check Valve and reclaimed water ID	
PGP-12 = 30 cm pop-up			

Examples:

PGP-04 = 10 cm pop-up, adjustable arc

PGP-04-2.5 = 10 cm pop-up, adjustable arc and 2.5 nozzle

PGP-12-CV-R-4.0 = 30 cm pop-up, adjustable arc, with Drain Check Valve and reclaimed water ID with 4.0 nozzle

I-20

Radius: **4.9 to 14.0 m**
Flow: **0.07 to 3.23 m³/hr; 1.2 to 53.8 l/min**

The I-20 is loaded with upgraded features such as FloStop™ Technology, check valves, and efficient nozzles that make it the perfect choice in a range of applications.

KEY BENEFITS

- Patented automatic arc return feature returns the turret back to the original arc pattern if vandalised; adjustable arc from 50° to 360°
- Non-strippable drive mechanism is protected from damage if turned in the opposite direction of travel
- Part and full-circle in one model is flexible for all landscapes and decreases inventory
- Headed and slotted setscrew allows radius adjustment with a Hunter Wrench or flat-blade screwdriver
- FloStop Technology stops the flow of water from individual sprinklers to change the nozzle or perform repairs
- Flat-top nozzles allow fast, easy insertion
- Drain Check Valve prevents low-head drainage (up to 3 m of elevation)

OPERATING SPECIFICATIONS

- Nozzle choices: 34
- Radius: 4.9 to 14.0 m
- Flow: 0.07 to 3.23 m³/hr; 1.2 to 53.8 l/min
- Recommended pressure range: 1.7 to 4.5 bar; 170 to 450 kPa
- Operating pressure range: 1.4 to 7.0 bar; 140 to 700 kPa
- Precipitation rate: 10 mm/hr approximately
- Nozzle trajectory: standard = 25°, low-angle = 13°
- Nozzle racks: Blue 1.5 to 8.0, Grey Low-Angle 2.0 to 4.5, Black 0.50 to 3.0, Green 6.0 to 13.0, MPR-25, MPR-30, MPR-35
- Warranty period: 5 years

FACTORY-INSTALLED OPTIONS

- No Drain Check Valve (NCV models)
- Reclaimed water ID
- Blue 1.5 to 4.0 Nozzles



I-20 Reclaimed

Available as a factory-installed option on all models

USER-INSTALLED OPTIONS

- HSJ-0 prefabricated 3/4" PVC Swing Joint

I-20 (PLASTIC) - SPECIFICATION BUILDER: ORDER 1 + 2 + 3 + 4

1 Model	2 Standard Features	3 Feature Options	4 Nozzle Options
I-20-00 = Shrub I-20-04 = 10 cm pop-up I-20-06 = 15 cm pop-up I-20-12 = 30 cm pop-up	Adjustable arc, plastic, check valve, 8 standard nozzles, and 4 low-angle nozzles	(blank) = No option NCV = Without check valve (only available on 10 cm model) R = Reclaimed water ID	Blue 1.5 to 8.0 Grey low-angle Black short-radius Green high-flow MPR-25-Q, T, H, F MPR-30-Q, T, H, F MPR-35-Q, T, H, F 1.5 to 4.0 = Only nozzles 1.5-4.0 can be factory-installed

I-20 (STAINLESS STEEL) - SPECIFICATION BUILDER: ORDER 1 + 2 + 3 + 4

1 Model	2 Standard Features	3 Feature Options	4 Nozzle Options
I-20-04-SS = 10 cm pop-up I-20-06-SS = 15 cm pop-up	Adjustable arc, stainless steel, check valve, 8 standard nozzles, and 4 low-angle nozzles	(blank) = No option NCV = Without check valve (only available on 10 cm model) R = Reclaimed water ID	Blue 1.5 to 8.0 Grey low-angle Black short-radius Green high-flow MPR-25-Q, T, H, F MPR-30-Q, T, H, F MPR-35-Q, T, H, F 1.5 to 4.0 = Only nozzles 1.5-4.0 can be factory-installed

Examples:

- I-20-04 = 10 cm pop-up, adjustable arc
- I-20-12-R-4.0 = 30 cm pop-up, adjustable arc, check valve, with reclaimed water ID, and 4.0 nozzle
- I-20-06-SS-R-3.0 = 15 cm pop-up, adjustable arc, stainless steel riser, with reclaimed water ID, and 3.0 nozzle



I-20-00

Overall height: 20 cm
Exposed diameter: 4.5 cm
Inlet size: 3/4"



I-20-04

Overall height: 19 cm
Pop-up height: 10 cm
Exposed diameter: 4.5 cm
Inlet size: 3/4"



I-20-06

Overall height: 25 cm
Pop-up height: 15 cm
Exposed diameter: 4.5 cm
Inlet size: 3/4"



I-20-12

Overall height: 43 cm
Pop-up height: 30 cm
Exposed diameter: 4.5 cm
Inlet size: 3/4"

PGP™ ULTRA & I-20 PRB

Radius: **4.9 to 14.0 m**

Flow: **0.07 to 2.22 m³/hr; 1.2 to 36.0 l/min**

The PGP Ultra and I-20 PRB Rotors are built to thrive in applications where high water pressure could otherwise lead to inefficient nozzle operation.

KEY BENEFITS

- Pressure-regulated body (3.1 bar; 310 kPa) reduces high incoming pressure to increase nozzle efficiency (requires dynamic pressure differential: 1.0 bar; 103 kPa)
- Patented automatic arc return feature returns the turret back to the original arc pattern if vandalised; adjustable arc from 50° to 360°
- Non-strippable drive mechanism is protected from damage if turned in the opposite direction of travel
- Part- and full-circle in one model for flexibility across landscapes and reduced inventory
- Headed and slotted setscrew allows radius adjustment with a Hunter Wrench or flat-blade screwdriver
- FloStop™ Technology stops the flow of water from individual sprinklers, to change the nozzle or perform repairs (I-20 only)
- Flat-top nozzles allow fast, easy insertion
- Drain Check Valve prevents low-head drainage (up to 3 m of elevation)

OPERATING SPECIFICATIONS

- Nozzle choices: 30
- Radius: 4.9 to 14.0 m
- Flow: 0.07 to 2.22 m³/hr; 1.2 to 36.0 l/min
- Nozzle discharge pressure: 3.1 bar; 310 kPa
- Operating pressure range: 4.1 to 7.0 bar; 410 to 700 kPa
- Precipitation rate: 10 mm/hr approximately
- Nozzle trajectory: standard = 25°, low-angle = 13°
- Nozzle racks: Blue 1.5 to 8.0, Grey Low-Angle 2.0 to 4.5, Black 0.50 to 3.0, Green 6.0 to 13.0, MPR-25, MPR-30, MPR-35
- Warranty period: 5 years

FACTORY-INSTALLED OPTIONS

- Reclaimed water ID
- Blue 1.5 to 4.0 Nozzles

USER-INSTALLED OPTIONS

- HSJ-0 prefabricated 3/4" PVC Swing Joint



PGP-00-PRB

Overall height: 22 cm
Exposed diameter: 4.5 cm
Inlet size: 3/4"

PGP-04-PRB

Overall height: 22 cm
Pop-up height: 10 cm
Exposed diameter: 4.5 cm
Inlet size: 3/4"



I-20-00-PRB

Overall height: 22 cm
Exposed diameter: 4.5 cm
Inlet size: 3/4"

I-20-04-PRB

Overall height: 22 cm
Pop-up height: 10 cm
Exposed diameter: 4.5 cm
Inlet size: 3/4"



I-20-06-PRB

Overall height: 27 cm
Pop-up height: 15 cm
Exposed diameter: 4.5 cm
Inlet size: 3/4"

PGP-ULTRA & I-20 PRB – SPECIFICATION BUILDER: ORDER 1 + 2 + 3 + 4

1 Model	2 Standard Features	3 Feature Options	4 Nozzle Options
PGP-00-PRB = Riser mount PGP-04-PRB = 10 cm pop-up	Adjustable arc, plastic riser, pressure-regulated body, 8 standard nozzles, and 4 low-angle nozzles	(blank) = No option CV = Drain Check Valve (PGP-04 only) CV-R = Drain Check Valve and reclaimed water ID	Blue 1.5 to 8.0 = Grey low-angle Black short-radius MPR-25, 30, 35 - Q, T, H, F
I-20-00-PRB = Riser mount I-20-04-PRB = 10 cm pop-up I-20-06-PRB = 15 cm pop-up	Adjustable arc, plastic riser, pressure-regulated body, 8 standard nozzles, and 4 low-angle nozzles	(blank) = No option R = Drain Check Valve and reclaimed water ID	Blue 1.5 to 8.0 = Grey low-angle Black short-radius MPR-25, 30, 35 - Q, T, H, F
I-20-04-SS-PRB = 10 cm pop-up I-20-06-SS-PRB = 15 cm pop-up	Adjustable arc, stainless steel riser, pressure-regulated body, 8 standard nozzles, and 4 low-angle nozzles	(blank) = No option R = Drain Check Valve and reclaimed water ID	Blue 1.5 to 8.0 = Grey low-angle Black short-radius MPR-25, 30, 35 - Q, T, H, F

Examples:

PGP-04-PRB = 10 cm pop-up, adjustable arc, plastic riser with no factory installed-nozzle

I-20-04-PRB-3.0-2.5 = 10 cm pop-up, adjustable arc, plastic riser with 3.0 nozzle

I-20-06-SS-PRB-R-MPR-25H = 15 cm pop-up, adjustable arc, stainless steel riser with MPR-25H

PGP ULTRA / I-20 / PRB BLUE STANDARD NOZZLE PERFORMANCE DATA

Nozzle	Pressure		Radius m	Flow		Precip mm/hr	
	bar	kPa		m ³ /hr	l/min	■	▲
1.5 ● Blue	1.7	170	8.8	0.27	4.5	7	8
	2.0	200	9.1	0.29	4.8	7	8
	2.5	250	9.4	0.32	5.4	7	8
	3.0	300	9.8	0.35	5.9	7	9
	3.5	350	9.8	0.38	6.4	8	9
	4.0	400	9.8	0.41	6.8	9	10
2.0 ● Blue	1.7	170	10.1	0.32	5.4	6	7
	2.0	200	10.1	0.35	5.8	7	8
	2.5	250	10.1	0.39	6.5	8	9
	3.0	300	10.4	0.43	7.2	8	9
	3.5	350	10.4	0.47	7.8	9	10
	4.0	400	10.4	0.50	8.3	9	11
2.5 ● Blue	1.7	170	10.1	0.39	6.6	8	9
	2.0	200	10.4	0.43	7.1	8	9
	2.5	250	10.7	0.48	8.0	8	10
	3.0	300	10.7	0.54	8.9	9	11
	3.5	350	10.7	0.58	9.7	10	12
	4.0	400	10.7	0.62	10.4	11	13
3.0 ● Blue	1.7	170	10.7	0.50	8.4	9	10
	2.0	200	10.7	0.54	9.1	10	11
	2.5	250	11.0	0.61	10.2	10	12
	3.0	300	11.6	0.68	11.4	10	12
	3.5	350	11.9	0.74	12.3	10	12
	4.0	400	11.9	0.79	13.2	11	13
4.0 ● Blue	1.7	170	11.3	0.68	11.3	11	12
	2.0	200	11.6	0.73	12.2	11	13
	2.5	250	11.9	0.81	13.6	12	13
	3.0	300	12.2	0.90	15.0	12	14
	3.5	350	12.2	0.97	16.2	13	15
	4.0	400	12.5	1.04	17.3	13	15
5.0 ● Blue	1.7	170	11.3	0.84	14.0	13	15
	2.0	200	11.6	0.91	15.2	14	16
	2.5	250	11.9	1.02	17.1	15	17
	3.0	300	12.8	1.14	19.0	14	16
	3.5	350	12.8	1.24	20.6	15	17
	4.0	400	12.8	1.32	22.1	16	19
6.0 ● Blue	1.7	170	11.6	1.01	16.8	15	17
	2.0	200	11.9	1.09	18.2	15	18
	2.5	250	12.2	1.22	20.4	16	19
	3.0	300	13.1	1.36	22.7	16	18
	3.5	350	13.1	1.47	24.5	17	20
	4.0	400	13.4	1.57	26.2	18	20
8.0 ● Blue	1.7	170	11.3	1.35	22.5	21	25
	2.0	200	11.9	1.46	24.3	21	24
	2.5	250	12.5	1.63	27.2	21	24
	3.0	300	13.4	1.81	30.2	20	23
	3.5	350	13.7	1.95	32.6	21	24
	4.0	400	14.0	2.09	34.8	21	25
4.5	450	14.0	2.22	36.9	23	26	

Note:

All precipitation rates are calculated for 180° operation. For the precipitation rate of a 360° sprinkler, divide by 2.

PGP ULTRA / I-20 / PRB GREY LOW-ANGLE NOZZLE PERFORMANCE DATA

Nozzle	Pressure		Radius m	Flow		Precip mm/hr	
	bar	kPa		m ³ /hr	l/min	■	▲
2.0 ● LA Grey	1.7	170	7.3	0.33	5.6	12	14
	2.0	200	7.6	0.36	6.0	12	14
	2.5	250	7.9	0.40	6.7	13	15
	3.0	300	8.2	0.45	7.4	13	15
	3.5	350	8.5	0.48	8.0	13	15
	4.0	400	8.8	0.52	8.6	13	15
2.5 ● LA Grey	1.7	170	7.9	0.44	7.3	14	16
	2.0	200	8.2	0.47	7.9	14	16
	2.5	250	8.8	0.53	8.8	14	16
	3.0	300	9.4	0.59	9.8	13	15
	3.5	350	10.1	0.64	10.6	13	15
	4.0	400	10.4	0.68	11.3	13	15
3.5 ● LA Grey	1.7	170	8.5	0.58	9.7	16	18
	2.0	200	8.8	0.62	10.3	16	18
	2.5	250	9.1	0.68	11.4	16	19
	3.0	300	10.1	0.75	12.5	15	17
	3.5	350	10.7	0.80	13.3	14	16
	4.0	400	11.0	0.85	14.1	14	16
4.5 ● LA Grey	1.7	170	8.2	0.71	11.8	21	24
	2.0	200	8.8	0.76	12.7	19	23
	2.5	250	9.1	0.84	14.1	20	23
	3.0	300	10.1	0.93	15.5	18	21
	3.5	350	10.7	1.00	16.6	18	20
	4.0	400	11.0	1.06	17.6	18	20
4.5	450	11.3	1.12	18.6	18	20	

PGP ULTRA / I-20 / PRB NOZZLES



Blue Standard / Grey Low-Angle (P/N 782900)

Flat-top nozzle for easy insertion coupled with a headed slotted adjustment screw for quick radius adjustment with a Hunter Wrench or a flat-blade screwdriver.



Pressure Regulation

Continual operating pressure of 3.1 bar; 310 kPa

I-20-04 Rotor with PRB Body



PR-075

Overall height: 5.7 cm
Inlet/outlet size: 3/4"
For use with all 3/4" inlet sprinklers models, regulates to 3.1 bar; 310 kPa

PGP ULTRA / I-20 GREEN HIGH-FLOW NOZZLE PERFORMANCE DATA

Nozzle	Pressure		Radius m	Flow		Precip mm/hr	
	bar	kPa		m ³ /hr	l/min	■	▲
10 Dk. Green	1.7	170	10.7	1.48	24.6	26	30
	2.0	200	11.9	1.60	26.7	23	26
	2.5	250	12.5	1.80	30.0	23	27
	3.0	300	12.8	2.01	33.5	25	28
	3.5	350	13.1	2.18	36.3	25	29
	4.0	400	13.7	2.34	39.0	25	29
13 Dk. Green	1.7	170	11.0	1.91	31.9	32	37
	2.0	200	12.2	2.08	34.6	28	32
	2.5	250	12.8	2.34	38.9	29	33
	3.0	300	13.1	2.61	43.4	30	35
	3.5	350	13.4	2.83	47.1	31	36
	4.0	400	13.7	3.03	50.5	32	37
6.0 LA Dk. Green	1.7	170	9.1	0.86	14.3	21	24
	2.0	200	9.4	0.94	15.6	21	24
	2.5	250	10.1	1.07	17.8	21	24
	3.0	300	10.7	1.20	20.0	21	24
	3.5	350	11.3	1.31	21.9	21	24
	4.0	400	11.6	1.42	23.6	21	24
8.0 LA Dk. Green	1.7	170	10.1	1.17	19.5	23	27
	2.0	200	10.7	1.28	21.3	22	26
	2.5	250	11.3	1.44	24.0	23	26
	3.0	300	11.6	1.61	26.9	24	28
	3.5	350	11.9	1.76	29.3	25	29
	4.0	400	12.5	1.89	31.5	24	28
4.5	450	12.5	2.01	33.6	26	30	

PGP ULTRA / I-20 / PRB BLACK SHORT-RADIUS NOZZLE PERFORMANCE DATA

Nozzle	Pressure		Radius m	Flow		Precip mm/hr	
	bar	kPa		m ³ /hr	l/min	■	▲
0.50 SR Black	1.7	170	4.9	0.07	1.2	6	7
	2.0	200	5.2	0.08	1.3	6	7
	2.5	250	5.2	0.09	1.5	7	8
	3.0	300	5.2	0.10	1.7	8	9
	3.5	350	5.5	0.12	1.9	8	9
	4.0	400	5.5	0.13	2.1	8	10
1.0 SR Black	1.7	170	4.9	0.16	2.7	14	16
	2.0	200	5.2	0.17	2.9	13	15
	2.5	250	5.2	0.19	3.2	14	17
	3.0	300	5.2	0.21	3.6	16	18
	3.5	350	5.5	0.23	3.8	15	18
	4.0	400	5.5	0.25	4.1	16	19
2.0 SR Black	1.7	170	4.9	0.28	4.7	24	27
	2.0	200	5.2	0.31	5.2	23	27
	2.5	250	5.2	0.36	6.0	27	31
	3.0	300	5.2	0.41	6.9	31	35
	3.5	350	5.5	0.45	7.6	30	35
	4.0	400	5.5	0.49	8.2	33	38
0.75 SR Black	1.7	170	6.7	0.12	2.0	5	6
	2.0	200	7.0	0.13	2.2	5	6
	2.5	250	7.0	0.15	2.4	6	7
	3.0	300	7.3	0.16	2.7	6	7
	3.5	350	7.6	0.17	2.9	6	7
	4.0	400	7.6	0.19	3.1	6	7
1.5 SR Black	1.7	170	6.7	0.23	3.8	10	12
	2.0	200	7.0	0.25	4.1	10	12
	2.5	250	7.0	0.28	4.6	11	13
	3.0	300	7.3	0.31	5.2	12	13
	3.5	350	7.6	0.34	5.6	12	13
	4.0	400	7.6	0.36	6.0	12	14
3.0 SR Black	1.7	170	6.7	0.53	8.9	24	27
	2.0	200	7.0	0.56	9.3	23	26
	2.5	250	7.0	0.60	10.0	24	28
	3.0	300	7.3	0.64	10.7	24	28
	3.5	350	7.6	0.67	11.2	23	27
	4.0	400	7.6	0.70	11.7	24	28
4.5	450	7.6	0.73	12.1	25	29	

PGP ULTRA / I-20 / PRB NOZZLES



Dk. Green High-Flow (P/N 444800)



Black Short-Radius (P/N 466100)



I-20 Rotor with Blue Standard Nozzle





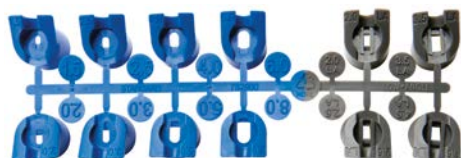

Note:

All precipitation rates are calculated for 180° operation. For the precipitation rate of a 360° sprinkler, divide by 2.

Convenient Nozzle Rack







PGP ULTRA / I-20 / PRB MPR-25 NOZZLE PERFORMANCE DATA

Nozzle	Pressure		Radius m	Flow		Precip mm/hr	
	bar	kPa		m ³ /hr	l/min	■	▲
90° 	1.7	170	7.0	0.17	3.0	13.7	15.8
	2.4	240	7.3	0.20	3.6	14.9	17.3
	3.1	310	7.6	0.23	3.6	15.6	18.1
	3.8	380	7.6	0.25	4.2	17.4	20.1
	4.5	450	7.6	0.27	4.8	18.9	21.9
120° 	1.7	170	7.0	0.23	3.6	13.9	16.0
	2.4	240	7.3	0.27	4.8	15.4	17.8
	3.1	310	7.6	0.31	5.4	16.2	18.7
	3.8	380	7.6	0.35	6.0	18.0	20.7
	4.5	450	7.6	0.38	6.6	19.6	22.6
180° 	1.7	170	7.0	0.33	5.4	13.3	15.4
	2.4	240	7.3	0.39	6.6	14.7	17.0
	3.1	310	7.6	0.45	7.2	15.5	17.9
	3.8	380	7.6	0.50	8.4	17.3	20.0
	4.5	450	7.6	0.55	9.0	18.9	21.8
360° 	1.7	170	7.0	0.63	10.8	12.8	14.8
	2.4	240	7.3	0.76	12.6	14.2	16.4
	3.1	310	7.6	0.87	14.4	14.9	17.3
	3.8	380	7.6	0.97	16.2	16.6	19.2
	4.5	450	7.6	1.05	17.4	18.1	20.9

MPR-25 NOZZLE







PGP ULTRA / I-20 / PRB MPR-35 NOZZLE PERFORMANCE DATA

Nozzle	Pressure		Radius m	Flow		Precip mm/hr	
	bar	kPa		m ³ /hr	l/min	■	▲
90° 	1.7	170	9.8	0.32	5.4	13.4	15.4
	2.4	240	10.4	0.38	6.6	14.1	16.3
	3.1	310	10.7	0.44	7.2	15.3	17.7
	3.8	380	10.7	0.48	7.8	17.0	19.6
	4.5	450	10.7	0.52	9.0	18.4	21.3
120° 	1.7	170	9.8	0.40	6.6	12.7	14.6
	2.4	240	10.4	0.49	8.4	13.6	15.8
	3.1	310	10.7	0.56	9.6	14.7	17.0
	3.8	380	10.7	0.62	10.2	16.4	18.9
	4.5	450	10.7	0.68	11.4	17.9	20.7
180° 	1.7	170	9.8	0.62	10.2	13.1	15.2
	2.4	240	10.4	0.76	12.6	14.1	16.3
	3.1	310	10.7	0.87	14.4	15.2	17.6
	3.8	380	10.7	0.96	16.2	16.9	19.5
	4.5	450	10.7	1.05	17.4	18.4	21.3
360° 	1.7	170	9.8	1.22	20.4	12.8	14.8
	2.4	240	10.4	1.50	25.2	14.0	16.2
	3.1	310	10.7	1.72	28.8	15.1	17.5
	3.8	380	10.7	1.91	31.8	16.8	19.4
	4.5	450	10.7	2.09	34.8	18.3	21.2



PGP ULTRA / I-20 / PRB MPR-30 NOZZLE PERFORMANCE DATA

Nozzle	Pressure		Radius m	Flow		Precip mm/hr	
	bar	kPa		m ³ /hr	l/min	■	▲
90° 	1.7	170	8.8	0.23	3.6	12.0	13.8
	2.4	240	9.1	0.28	4.8	13.4	15.4
	3.1	310	9.1	0.32	5.4	15.2	17.6
	3.8	380	9.1	0.35	6.0	17.0	19.6
	4.5	450	9.1	0.38	6.6	18.4	21.2
120° 	1.7	170	8.8	0.30	4.8	11.7	13.5
	2.4	240	9.1	0.37	6.0	13.2	15.2
	3.1	310	9.1	0.42	7.2	15.1	17.4
	3.8	380	9.1	0.47	7.8	16.8	19.4
	4.5	450	9.1	0.51	8.4	18.3	21.1
180° 	1.7	170	8.8	0.49	8.4	12.5	14.4
	2.4	240	9.1	0.59	9.6	14.1	16.2
	3.1	310	9.1	0.67	11.4	16.1	18.6
	3.8	380	9.1	0.75	12.6	17.9	20.7
	4.5	450	9.1	0.82	13.8	19.6	22.6
360° 	1.7	170	8.8	0.96	16.2	12.3	14.2
	2.4	240	9.1	1.15	19.2	13.8	15.9
	3.1	310	9.1	1.31	21.6	15.7	18.1
	3.8	380	9.1	1.45	24.0	17.4	20.0
	4.5	450	9.1	1.57	26.4	18.8	21.7

MPR-30 NOZZLE



PGP-04 Ultra Rotor with MPR-30 Nozzle



I-25

Radius: **11.9 to 21.6 m**
Flow: **0.82 to 7.24 m³/hr; 13.6 to 120.2 l/min**

The reliable, durable, and versatile I-25 Rotor offers an expansive nozzle selection that makes it the perfect choice for large turf applications.

ROTORS

KEY BENEFITS

- Patented automatic arc return feature returns the turret back to the original arc pattern if vandalised; adjustable arc from 50° to 360°
- Non-strippable drive mechanism is protected from damage if turned in the opposite direction of travel
- Part- and full-circle in one model for flexibility across landscapes and reduced inventory
- Colour-coded nozzles make identification easy
- Drain Check Valve prevents low-head drainage (up to 3 m of elevation)

OPERATING SPECIFICATIONS

- Nozzle choices: 11
- Radius: 11.9 to 21.6 m
- Flow: 0.82 to 7.24 m³/hr; 13.6 to 120.2 l/min
- Recommended pressure range: 2.5 to 7.0 bar; 250 to 700 kPa
- Warranty period: 5 years
- Operating pressure range: 2.5 to 7.0 bar; 250 to 700 kPa
- Precipitation rate: 15 mm/hr approximately
- Nozzle trajectory: standard = 25°

FACTORY-INSTALLED OPTIONS

- Reclaimed water ID
- High-speed rotation

USER-INSTALLED OPTIONS

- HSJ-1 prefabricated 1" (25 mm) PVC Swing Joint



I-25-04

Overall height: 20 cm
Pop-up height: 10 cm
Exposed diameter: 5 cm
Inlet size: 1" (25 mm) BSP



I-25-06

Overall height: 26 cm
Pop-up height: 15 cm
Exposed diameter: 5 cm
Inlet size: 1" (25 mm) BSP



I-25 Reclaimed

Available as a factory-installed option on all models



I-25 High-Speed

Available as a factory-installed option on all stainless steel models

I-25 (PLASTIC) - SPECIFICATION BUILDER: ORDER 1 + 2 + 3 + 4

1 Model	2 Standard Features	3 Feature Options	4 Nozzle Options
I-25-04 = 10 cm pop-up I-25-06 = 15 cm pop-up	Adjustable arc, plastic riser, check valve, and 5 nozzles	B = BSP inlet threads R = Reclaimed water ID	4 to 28 = Factory-installed nozzle number

I-25 (STAINLESS STEEL) - SPECIFICATION BUILDER: ORDER 1 + 2 + 3 + 4

1 Model	2 Standard Features	3 Feature Options	4 Nozzle Options
I-25-04-SS = 10 cm pop-up I-25-06-SS = 15 cm pop-up	Adjustable arc, stainless steel riser, check valve, and 5 nozzles	B = BSP inlet threads R = Reclaimed water ID HS = High-speed HS-R = High-speed and reclaimed water ID	4 to 28 = Factory-installed nozzle number

Examples:

I-25-04-B = 10 cm pop-up, adjustable arc, BSP inlet threads

I-25-04-SS-R-B-18 = 10 cm pop-up, adjustable arc, stainless steel riser, reclaimed water ID, and 18 nozzle, BSP inlet threads

I-25-06-SS-B = 15 cm pop-up, adjustable arc, stainless steel riser, BSP inlet threads

I-25 STANDARD NOZZLE PERFORMANCE DATA

Nozzle	Pressure		Radius		Flow		Precip mm/hr		Nozzle	Pressure		Radius		Flow		Precip mm/hr	
	bar	kPa	m	m ³ /hr	l/min	■	▲	bar		kPa	m	m ³ /hr	l/min	■	▲		
4 ● Yellow	2.5	250	11.9	0.82	13.6	12	13	15 ● Grey*	3.0	300	16.8	2.86	47.7	20	24		
	3.0	300	12.2	0.91	15.2	12	14		3.5	350	17.1	3.05	50.8	21	24		
	3.5	350	12.5	0.98	16.4	13	15		4.0	400	17.4	3.22	53.7	21	25		
	4.0	400	12.5	1.05	17.5	13	16		4.5	450	17.4	3.38	56.3	22	26		
	4.5	450	12.8	1.11	18.6	14	16		5.0	500	17.4	3.53	58.8	23	27		
	5.0	500	13.1	1.18	19.6	14	16		5.5	550	17.7	3.69	61.5	24	27		
7 ● Orange*	2.5	250	13.4	1.44	24.0	16	19	18 ● Red	6.0	600	18.0	3.82	63.7	24	27		
	3.0	300	14.0	1.54	25.6	16	18		6.2	620	18.3	3.88	64.6	23	27		
	3.5	350	14.3	1.61	26.9	16	18		3.0	300	17.4	30.8	51.4	20	24		
	4.0	400	14.3	1.68	28.0	16	19		3.5	350	17.7	3.31	55.2	21	24		
	4.5	450	14.6	1.75	29.1	16	19		4.0	400	18.0	3.52	58.7	22	25		
	5.0	500	14.9	1.81	30.1	16	19		4.5	450	18.3	3.72	62.0	22	26		
8 ● Lt. Brown	2.5	250	14.0	1.65	27.5	17	19	20 ● Dk. Brown*	5.0	500	18.9	3.91	65.2	22	25		
	3.0	300	14.3	1.81	30.1	18	20		5.5	550	19.2	4.11	68.5	22	26		
	3.5	350	14.9	1.94	32.3	17	20		6.0	600	19.5	4.28	71.4	23	26		
	4.0	400	15.2	2.05	34.2	18	20		6.2	620	19.5	4.35	72.5	23	26		
	4.5	450	15.2	2.16	36.0	19	22		3.5	350	18.0	3.72	62.1	23	27		
	5.0	500	15.5	2.27	37.8	19	22		4.0	400	18.6	3.97	66.2	23	27		
10 ● Lt. Green*	2.5	250	15.8	2.38	39.6	19	22	23 ● Dk. Green	5.5	550	19.5	4.66	77.7	25	28		
	3.0	300	15.2	2.15	35.8	18	21		6.0	600	19.8	4.86	81.0	25	29		
	3.5	350	15.5	2.32	38.6	19	22		6.5	650	20.1	5.05	84.2	25	29		
	4.0	400	15.8	2.48	41.3	20	23		6.9	690	20.4	5.21	86.8	25	29		
	4.5	450	16.2	2.63	43.9	20	23		3.5	350	18.6	4.56	76.0	26	30		
	5.0	500	16.2	2.78	46.3	21	25		4.0	400	19.2	4.88	81.3	26	31		
13 ● Lt. Blue	2.5	250	16.5	2.91	48.5	21	25	25 ● Dk. Blue*	4.5	450	19.5	5.18	86.3	27	31		
	3.0	300	15.8	2.38	39.6	19	22		5.0	500	19.8	5.47	91.1	28	32		
	3.5	350	16.2	2.57	42.8	20	23		5.5	550	20.1	5.78	96.3	29	33		
	4.0	400	16.5	2.75	45.7	20	23		6.0	600	20.1	6.04	100.6	30	34		
	4.5	450	16.5	2.91	48.5	21	25		6.5	650	20.4	6.29	104.8	30	35		
	5.0	500	16.8	3.04	51.2	22	25		6.9	690	20.7	6.50	108.3	30	35		
15 ● Grey*	2.5	250	13.4	1.44	24.0	16	19	28 ● Black	3.5	350	19.2	4.86	80.9	26	30		
	3.0	300	14.0	1.54	25.6	16	18		4.0	400	19.8	5.23	87.1	27	31		
	3.5	350	14.3	1.61	26.9	16	18		4.5	450	20.1	5.58	93.1	28	32		
	4.0	400	14.3	1.68	28.0	16	19		5.0	500	20.4	5.92	98.7	28	33		
	4.5	450	14.6	1.75	29.1	16	19		5.5	550	21.0	6.29	104.9	28	33		
	5.0	500	14.9	1.81	30.1	16	19		6.0	600	21.0	6.60	110.0	30	34		
18 ● Red	2.5	250	14.0	1.65	27.5	17	19	25 ● Dk. Blue*	6.5	650	21.3	6.90	115.1	30	35		
	3.0	300	14.3	1.81	30.1	18	20		6.9	690	21.6	7.15	119.2	31	35		
	3.5	350	14.9	1.94	32.3	17	20		3.5	350	19.2	4.86	80.9	26	30		
	4.0	400	15.2	2.05	34.2	18	20		4.0	400	19.8	5.23	87.1	27	31		
	4.5	450	15.2	2.16	36.0	19	22		4.5	450	20.1	5.58	93.1	28	32		
	5.0	500	15.5	2.27	37.8	19	22		5.0	500	20.4	5.92	98.7	28	33		
20 ● Dk. Brown*	2.5	250	15.8	2.38	39.6	19	22	28 ● Black	5.5	550	21.0	6.29	104.9	28	33		
	3.0	300	15.2	2.15	35.8	18	21		6.0	600	21.0	6.60	110.0	30	34		
	3.5	350	15.5	2.32	38.6	19	22		6.5	650	21.3	6.90	115.1	30	35		
	4.0	400	15.8	2.48	41.3	20	23		6.9	690	21.6	7.15	119.2	31	35		
	4.5	450	16.2	2.63	43.9	20	23		3.5	350	18.3	5.31	88.5	32	37		
	5.0	500	16.2	2.78	46.3	21	25		4.0	400	19.2	5.63	93.8	31	35		
23 ● Dk. Green	2.5	250	16.5	2.91	48.5	21	25	25 ● Dk. Blue*	4.5	450	20.1	5.93	98.8	29	34		
	3.0	300	15.8	2.38	39.6	19	22		5.0	500	20.4	6.29	104.9	28	33		
	3.5	350	16.2	2.57	42.8	20	23		5.5	550	21.0	6.60	110.0	30	34		
	4.0	400	16.5	2.75	45.7	20	23		6.0	600	21.0	6.90	115.1	30	35		
	4.5	450	16.5	2.91	48.5	21	25		6.5	650	21.3	7.15	119.2	31	35		
	5.0	500	16.8	3.04	51.2	22	25		6.9	690	21.6	7.41	123.3	31	36		
25 ● Dk. Blue*	2.5	250	17.1	3.39	56.4	23	27	28 ● Black	3.5	350	18.3	5.31	88.5	32	37		
	3.0	300	16.5	2.91	48.5	21	25		4.0	400	19.2	5.63	93.8	31	35		
	3.5	350	16.8	3.04	51.2	22	25		4.5	450	20.1	5.93	98.8	29	34		
	4.0	400	17.1	3.39	56.4	23	27		5.0	500	20.7	6.21	103.5	29	33		
	4.5	450	17.1	3.54	60.0	23	27		5.5	550	21.3	6.52	108.6	29	33		
	5.0	500	17.4	3.90	66.0	23	27		6.0	600	21.3	6.77	112.8	30	34		
28 ● Black	2.5	250	18.3	4.66	77.7	25	28	25 ● Dk. Blue*	6.5	650	21.6	7.01	116.9	30	35		
	3.0	300	17.7	4.35	72.5	23	26		6.9	690	21.6	7.21	120.2	31	36		
	3.5	350	18.0	4.86	81.0	25	29		3.5	350	19.2	4.86	80.9	26	30		
	4.0	400	18.6	5.23	87.1	27	31		4.0	400	19.8	5.23	87.1	27	31		
	4.5	450	18.9	5.60	93.1	28	32		4.5	450	20.1	5.58	93.1	28	32		
	5.0	500	19.2	6.00	99.0	28	33		5.0	500	20.4	5.92	98.7	28	33		

* Five standard nozzles included with each sprinkler.

Note:
All precipitation rates are calculated for 180° operation. For the precipitation rate of a 360° sprinkler, divide by 2.

I-25 NOZZLE



I-25 HIGH-SPEED NOZZLE PERFORMANCE DATA							
Nozzle	Pressure		Radius m	Flow		Precip mm/hr	
	bar	kPa		m ³ /hr	l/min	■	▲
04 ● Yellow	2.5	250	11.0	0.81	13.6	14	16
	3.0	300	11.3	0.91	15.1	14	16
	3.5	350	11.6	0.99	16.4	15	17
	4.0	400	11.6	1.06	17.6	16	18
	4.5	450	11.6	1.13	18.8	17	19
	5.0	500	11.9	1.19	19.9	17	19
07 ● Orange*	2.5	250	11.9	1.32	22.0	19	22
	3.0	300	12.2	1.46	24.3	20	23
	3.5	350	12.5	1.57	26.2	20	23
	4.0	400	12.8	1.68	27.9	20	24
	4.5	450	13.1	1.78	29.6	21	24
	5.0	500	13.4	1.87	31.1	21	24
08 ● Lt. Brown	2.5	250	12.5	1.54	25.7	20	23
	3.0	300	12.8	1.72	28.6	21	24
	3.5	350	13.1	1.86	31.0	22	25
	4.0	400	13.4	2.00	33.3	22	26
	4.5	450	13.4	2.13	35.4	24	27
	5.0	500	13.7	2.25	37.5	24	28
10 ● Lt. Green*	3.0	300	13.7	2.15	35.8	23	26
	3.5	350	14.0	2.32	38.6	24	27
	4.0	400	14.3	2.48	41.3	24	28
	4.5	450	14.6	2.63	43.9	25	28
	5.0	500	14.9	2.78	46.3	25	29
	5.5	550	15.2	2.94	48.9	25	29
13 ● Lt. Blue	3.0	300	14.3	2.38	39.6	23	27
	3.5	350	14.6	2.57	42.8	24	28
	4.0	400	14.9	2.75	45.7	25	28
	4.5	450	15.2	2.91	48.5	25	29
	5.0	500	15.5	3.07	51.2	25	29
	5.5	550	15.5	3.24	54.0	27	31

I-25 NOZZLE							
Nozzle	Pressure		Radius m	Flow		Precip mm/hr	
	bar	kPa		m ³ /hr	l/min	■	▲
15 ● Grey*	3.0	300	14.6	2.86	47.7	27	31
	3.5	350	14.9	3.05	50.8	27	32
	4.0	400	15.2	3.22	53.7	28	32
	4.5	450	15.5	3.38	56.3	28	32
	5.0	500	16.2	3.53	58.8	27	31
	5.5	550	16.5	3.69	61.5	27	31
	6.0	600	16.5	3.82	63.7	28	33
	6.2	620	16.5	3.88	64.6	29	33
18 ● Red	3.0	300	14.9	3.08	51.4	28	32
	3.5	350	15.2	3.31	55.2	29	33
	4.0	400	15.5	3.52	58.7	29	34
	4.5	450	16.2	3.72	62.0	29	33
	5.0	500	16.8	3.91	65.2	28	32
	5.5	550	17.4	4.11	68.5	27	31
	6.0	600	17.4	4.28	71.4	28	33
	6.2	620	17.4	4.35	72.5	29	33
20 ● Dk. Brown*	3.5	350	15.5	3.72	62.1	31	36
	4.0	400	16.2	3.97	66.2	30	35
	4.5	450	16.5	4.20	70.1	31	36
	5.0	500	17.1	4.42	73.7	30	35
	5.5	550	17.7	4.66	77.7	30	34
	6.0	600	17.7	4.86	81.0	31	36
	6.5	650	18.0	5.05	84.2	31	36
	6.9	690	18.0	5.21	86.8	32	37
23 ● Dk. Green	3.5	350	16.5	4.56	76.0	34	39
	4.0	400	17.1	4.88	81.3	33	39
	4.5	450	17.4	5.18	86.3	34	40
	5.0	500	17.7	5.47	91.1	35	40
	5.5	550	18.3	5.78	96.3	35	40
	6.0	600	18.3	6.04	100.6	36	42
	6.5	650	18.6	6.29	104.8	36	42
	6.9	690	18.6	6.50	108.3	38	43
25 ● Dk. Blue*	3.5	350	17.1	4.86	80.9	33	38
	4.0	400	17.7	5.23	87.1	33	39
	4.5	450	18.3	5.58	93.1	33	39
	5.0	500	18.9	5.92	98.7	33	38
	5.5	550	19.5	6.29	104.9	33	38
	6.0	600	19.8	6.60	110.0	34	39
	6.5	650	20.1	6.90	115.1	34	39
	6.9	690	20.1	7.15	119.2	35	41
28 ● Black	3.5	350	17.4	5.31	88.5	35	41
	4.0	400	17.7	5.63	93.8	36	42
	4.5	450	18.0	5.93	98.8	37	42
	5.0	500	18.3	6.21	103.5	37	43
	5.5	550	18.9	6.52	108.6	36	42
	6.0	600	19.5	6.77	112.8	36	41
	6.5	650	19.8	7.01	116.9	36	41
	6.9	690	20.4	7.21	120.2	35	40

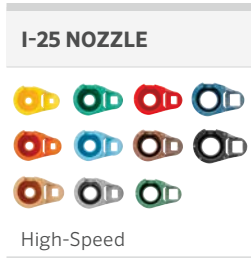

* 5 standard nozzles included with each sprinkler.

Notes:

All precipitation rates are calculated for 180° operation. For the precipitation rate of a 360° sprinkler, divide by 2.

I-40

Radius: **13.1 to 23.2 m**
Flow: **1.63 to 6.84 m³/hr; 27.2 to 114.1 l/min**

The I-40 Rotor has a comprehensive list of upgraded features that make it the top choice for demanding, large turf projects.

KEY BENEFITS

- Patented automatic arc return feature returns the turret back to the original arc pattern if vandalised; adjustable arc from 50° to 360°
- Non-strippable drive mechanism is protected from damage if turned in the opposite direction of travel
- Part- and full-circle in one model for flexibility across landscapes and reduced inventory
- Colour-coded nozzles make identification easy
- Available opposing nozzle model for even watering in full-circle applications (I-40-ON model)
- Drain Check Valve prevents low-head drainage (up to 4.5 m of elevation)

OPERATING SPECIFICATIONS

- Nozzle choices: 12
- Radius I-40: 13.1 to 21.3 m
- Radius I-40-ON: 15.2 to 23.2 m
- Flow I-40: 1.63 to 6.84 m³/hr; 27.2 to 114.1 l/min
- Flow I-40-ON: 2.75 to 7.76 m³/hr; 45.8 to 129.4 l/min
- Warranty period: 5 years
- Recommended pressure range: 2.5 to 7.0 bar; 250 to 700 kPa
- Operating pressure range: 2.5 to 7.0 bar; 250 to 700 kPa
- Precipitation rates: 15 mm/hr approximately
- Nozzle trajectory: standard = 25°

FACTORY-INSTALLED OPTIONS

- Reclaimed water ID
- High-speed rotation

USER-INSTALLED OPTIONS

- HSJ-1 prefabricated 1" (25 mm) PVC Swing Joint



I-40-04
Overall height: 20 cm
Pop-up height: 10 cm
Exposed diameter: 5 cm
Inlet size: 1" (25 mm) BSP



I-40-06
Overall height: 26 cm
Pop-up height: 15 cm
Exposed diameter: 5 cm
Inlet size: 1" (25 mm) BSP



I-40 Reclaimed
Available as a factory-installed option on all models



I-40 High-Speed
Available as a factory-installed option on all models

I-40 - SPECIFICATION BUILDER: ORDER 1 + 2 + 3 + 4

1 Model	2 Standard Features	3 Feature Options	4 Nozzle Options
I-40-04-SS = 10 cm pop-up I-40-06-SS = 15 cm pop-up	Adjustable arc, stainless steel riser, check valve, and 6 nozzles	B = BSP inlet threads R = Reclaimed water ID HS = High-speed HS-R = High-speed and reclaimed water ID	8 to 25 = Factory-installed nozzle number

I-40-ON - SPECIFICATION BUILDER: ORDER 1 + 2 + 3 + 4

1 Model	2 Standard Features	3 Feature Options	4 Nozzle Options
I-40-04-SS-ON = 10 cm pop-up I-40-06-SS-ON = 15 cm pop-up	Full-circle, opposing nozzle, stainless steel riser, check valve, and 6 nozzles	B = BSP inlet threads R = Reclaimed water ID ON = Full-circle opposing nozzle ON-R = Full circle opposing nozzles, reclaimed water ID	15 to 28 = Factory-installed nozzle number

Examples:

- I-40-04-SS-B = 10 cm pop-up, BSP inlet threads
- I-40-04-SS-ON-R-B-23 = 10 cm pop-up, full-circle opposing nozzles, reclaimed water ID, 23 nozzle, BSP inlet threads
- I-40-06-SS-15-B = 15 cm pop-up, 15 nozzle, BSP inlet threads

I-40 STANDARD NOZZLE PERFORMANCE DATA

Nozzle	Pressure		Radius m	Flow		Precip mm/hr	
	bar	kPa		m ³ /hr	l/min	■	▲
08 Lt. Brown	2.5	250	13.1	1.63	27.2	19	22
	3.0	300	13.4	1.80	30.0	20	23
	3.5	350	13.7	1.94	32.3	21	24
	4.0	400	14.0	2.06	34.4	21	24
	4.5	450	14.0	2.18	36.3	22	26
	5.0	500	14.3	2.29	38.2	22	26
	5.5	550	14.6	2.41	40.2	23	26
10 Lt. Green	3.0	300	14.6	2.20	36.6	21	24
	3.5	350	14.9	2.37	39.4	21	24
	4.0	400	15.2	2.52	42.0	22	25
	4.5	450	15.5	2.67	44.5	22	25
	5.0	500	15.5	2.81	46.8	23	27
	5.5	550	15.8	2.96	49.3	24	27
	6.0	600	16.2	3.08	51.4	24	27
13 Lt. Blue	3.0	300	14.9	2.36	39.4	21	24
	3.5	350	15.2	2.55	42.6	22	25
	4.0	400	15.5	2.73	45.5	23	26
	4.5	450	15.5	2.90	48.3	24	28
	5.0	500	15.8	3.06	51.0	24	28
	5.5	550	16.2	3.23	53.9	25	29
	6.0	600	16.5	3.38	56.3	25	29
15 Grey	3.0	300	16.2	2.93	48.8	22	26
	3.5	350	16.5	3.19	53.2	24	27
	4.0	400	16.8	3.44	57.3	24	28
	4.5	450	17.1	3.67	61.2	25	29
	5.0	500	17.4	3.89	64.9	26	30
	5.5	550	18.0	4.14	68.9	26	30
	6.0	600	18.3	4.34	72.4	26	30
	6.2	620	18.3	4.43	73.8	26	31
23 Dk. Green	3.5	350	18.6	4.48	74.6	26	30
	4.0	400	18.9	4.76	79.4	27	31
	4.5	450	19.2	5.03	83.9	27	32
	5.0	500	19.5	5.29	88.1	28	32
	5.5	550	19.8	5.56	92.7	28	33
	6.0	600	20.1	5.79	96.5	29	33
	6.2	620	20.1	5.89	98.1	29	34
	6.5	650	20.1	6.01	100.2	30	34
	6.9	690	20.4	6.19	103.2	30	34
25 Dk. Blue	3.5	350	19.8	4.98	83.0	25	29
	4.0	400	20.1	5.33	88.7	26	30
	4.5	450	20.4	5.65	94.2	27	31
	5.0	500	20.7	5.96	99.3	28	32
	5.5	550	21.0	6.29	104.9	28	33
	6.0	600	21.0	6.57	109.6	30	34
	6.2	620	21.0	6.69	111.5	30	35
	6.5	650	21.3	6.84	114.1	30	35
	6.9	690	21.3	7.07	117.8	31	36

I-40 HIGH-SPEED NOZZLE PERFORMANCE DATA

Nozzle	Pressure		Radius m	Flow		Precip mm/hr	
	bar	kPa		m ³ /hr	l/min	■	▲
08 Lt. Brown	2.5	250	12.2	1.63	27.2	22	25
	3.0	300	12.5	1.80	30.0	23	27
	3.5	350	12.8	1.94	32.3	24	27
	4.0	400	12.8	2.06	34.4	25	29
	4.5	450	13.1	2.18	36.3	25	29
	5.0	500	13.4	2.29	38.2	25	29
	5.5	550	13.4	2.41	40.2	27	31
10 Lt. Green	3.0	300	13.4	2.20	36.6	34	28
	3.5	350	13.7	2.37	39.4	25	29
	4.0	400	14.0	2.52	42.0	26	30
	4.5	450	14.0	2.67	44.5	27	31
	5.0	500	14.3	2.81	46.8	27	32
	5.5	550	14.6	2.96	49.3	28	32
	6.0	600	14.6	3.08	51.4	29	33
13 Lt. Blue	3.0	300	13.7	2.36	39.4	25	29
	3.5	350	14.0	2.55	42.6	26	30
	4.0	400	14.3	2.73	45.5	27	31
	4.5	450	14.3	2.90	48.3	28	33
	5.0	500	14.6	3.06	51.0	29	33
	5.5	550	14.9	3.23	53.9	29	33
	6.0	600	14.9	3.38	56.3	30	35
15 Grey	3.0	300	15.2	2.93	48.8	25	29
	3.5	350	15.5	3.19	53.2	26	30
	4.0	400	15.8	3.44	57.3	27	32
	4.5	450	15.8	3.67	61.2	29	34
	5.0	500	16.2	3.89	64.9	30	34
	5.5	550	16.5	4.14	68.9	31	35
	6.0	600	16.5	4.34	72.4	32	39
	6.2	620	16.5	4.43	73.8	33	38
23 Dk. Green	3.5	350	16.8	4.48	74.6	32	37
	4.0	400	17.4	4.76	79.4	32	36
	4.5	450	17.7	5.03	83.9	32	37
	5.0	500	17.7	5.29	88.1	34	39
	5.5	550	18.0	5.56	92.7	34	40
	6.0	600	18.3	5.79	96.5	35	40
	6.2	620	18.6	5.89	98.1	34	39
	6.5	650	18.6	6.01	100.2	35	40
	6.9	690	18.6	6.19	103.2	36	41
25 Dk. Blue	3.5	350	17.4	4.98	83.0	33	38
	4.0	400	18.0	5.33	88.7	33	38
	4.5	450	18.3	5.65	94.2	34	39
	5.0	500	18.6	5.96	99.3	34	40
	5.5	550	18.9	6.29	104.9	35	41
	6.0	600	19.2	6.57	109.6	36	41
	6.2	620	19.5	6.69	111.5	35	41
	6.5	650	19.5	6.84	114.1	36	42
	6.9	690	19.5	7.07	117.8	37	43

I-40 NOZZLES



Standard/
High-Speed



Note:
All precipitation rates are calculated for 180° operation. For the precipitation rate of a 360° sprinkler, divide by 2.

I-40 DUAL OPPOSING NOZZLE PERFORMANCE DATA

Nozzle	Pressure		Radius m	Flow		Precip mm/hr	
	bar	kPa		m ³ /hr	l/min	■	▲
15 ● Grey	3.0	300	15.2	2.75	45.8	12	14
	3.5	350	15.8	2.91	48.5	12	13
	4.0	400	16.2	3.06	51.0	12	14
	4.5	450	16.8	3.20	53.3	11	13
	5.0	500	17.1	3.32	55.4	11	13
	5.5	550	17.4	3.46	57.7	11	13
	6.0	600	17.7	3.58	59.6	11	13
18 ● Red	3.0	300	17.4	2.90	48.3	10	11
	3.5	350	17.7	3.15	52.5	10	12
	4.0	400	18.0	3.38	56.4	10	12
	4.5	450	18.0	3.61	60.1	11	13
	5.0	500	18.3	3.82	63.7	11	13
	5.5	550	18.9	4.05	67.5	11	13
	6.0	600	19.2	4.25	70.8	12	13
20 ● Dk. Brown	3.5	350	18.3	3.98	66.2	12	14
	4.0	400	18.9	4.26	71.1	12	14
	4.5	450	19.2	4.54	75.6	12	14
	5.0	500	19.5	4.80	80.0	13	15
	5.5	550	20.1	5.08	84.7	13	15
	6.0	600	19.8	5.32	88.7	14	16
	6.2	620	19.8	5.42	90.4	14	16
23 ● Dk. Green	3.5	350	18.9	4.23	70.6	12	14
	4.0	400	19.5	4.55	75.8	12	14
	4.5	450	19.8	4.85	80.8	12	14
	5.0	500	20.1	5.14	85.6	13	15
	5.5	550	20.4	5.45	90.8	13	15
	6.0	600	20.7	5.71	95.1	13	15
	6.2	620	20.7	5.82	97.0	14	16
25 ● Dk. Blue	3.5	350	19.5	4.60	76.7	12	14
	4.0	400	20.1	4.92	82.1	12	14
	4.5	450	20.4	5.23	87.2	13	14
	5.0	500	20.7	5.52	92.0	13	15
	5.5	550	21.0	5.84	97.3	13	15
	6.0	600	21.3	6.10	101.7	13	15
	6.2	620	21.3	6.22	103.6	14	16
28 ● Black	3.5	350	19.8	5.73	95.5	15	17
	4.0	400	20.4	6.07	101.1	15	17
	4.5	450	21.0	6.38	106.4	14	17
	5.0	500	21.3	6.68	111.3	15	17
	5.5	550	21.9	7.00	116.7	15	17
	6.0	600	22.3	7.27	121.1	15	17
	6.2	620	22.3	7.38	122.9	15	17
6.5	650	22.6	7.52	125.3	15	17	
6.9	690	23.2	7.73	128.8	14	17	

Note:

Precipitation rates for the ON-Opposing Nozzles models are calculated at 360°.

I-40 NOZZLES



Opposing

Front

Back



I-40 Turf Cup Kit Option

Available as a field-installed option on all models
P/N TURFCUPKITI40

I-40 Opposing Nozzle 360° Model



I-80

The highly versatile and efficient I-80 Rotor is the first commercial sports turf rotor with no-dig Total-Top-Serviceability.

Radius: **19.2 to 29.6 m**
Flow: **4.59 to 13.5 m³/hr;**
76.5 to 225.6 l/min

ROTORS

KEY BENEFITS

- Exclusive Total-Top-Service (TTS) design provides convenient no-dig servicing
- PressurePort™ Technology and forward-facing triple nozzles (I-80) or opposing triple nozzles (I-80-ON) create exceptional nozzle uniformity in part- and full-circle applications
- Tool-free, part- and full-circle arc adjustment mechanism makes fast, easy installation and reduces inventory (70° to 360°)
- Ratcheting stainless steel riser allows setting of right-side fixed arc alignment to the landscape without rotor disassembly

OPERATING SPECIFICATIONS

- I-80
 - Nozzle choices: 7 standard
 - Radius: 19.8 to 28.7 m
 - Flow: 4.6 to 13.5 m³/hr;
76.5 to 225.6 l/min
- I-80-ON
 - Nozzle choices: 7 standard
 - Radius: 19.2 to 29.6 m
 - Flow: 4.9 to 13.3 m³/hr;
81.8 to 221.4 l/min
- All I-80 Rotors are pressure-rated at 10 bar; 1,000 kPa
- Recommended pressure range: 3.4 to 6.9 bar; 340 to 690 kPa
- Operating pressure range: 2.7 to 10.3 bar; 275 to 1,030 kPa
- Precipitation rates: 10 mm/hr approximately
- Warranty period: 5 years
- QuickCheck™ Arc Mechanism (I-80) for fast arc adjustment and review of the arc setting
- Drain Check Valve prevents low-head drainage (up to 5' of elevation)

FACTORY-INSTALLED OPTIONS

- Exclusive Turf Cup option for an aesthetically clean and safe installation
 - No-dig servicing of riser assembly
 - No-dig arc adjustments
 - Quick-release turf cup assembly
 - Threads in cup lock/retain the turf

USER-INSTALLED OPTIONS

- Rubber Cover Kit P/N: 959300SP
- Turf Cup Kit P/N: 959400SP
- HSJ prefabricated PVC Swing Joints
- Reclaimed water ID 450105



I-80-04-SS Pop-Up
I-80-04-SS-ON Pop-Up

Overall height: 25 cm
Pop-up height: 9.5 cm
Exposed diameter: 11 cm
Inlet size: 1½" (40 mm)



I-80-04-SS-TC Turf Cup
I-80-04-SS-ON-TC Turf Cup

Overall height: 29 cm
Pop-up height: 9.5 cm
Exposed diameter: 8.9 cm
Inlet size: 1½" (40 mm)



I-80 Turf Cup Kit
P/N 959400SP



I-80 Rubber Cover Kit
P/N 959300SP

I-80 - SPECIFICATION BUILDER: ORDER 1 + 2 + 3 + 4















1 Model	2 Standard Features	3 Nozzle Options
I-80-04-SS-B = 10 cm pop-up	Adjustable arc, stainless steel riser, check valve, with BSP inlet threads, and 15 nozzle options	23 to 53 = Factory-installed nozzle number, no nozzle pack
I-80-04-SS-TC-B = 10 cm pop-up with turf cup	Adjustable arc, stainless steel riser, check valve, factory-installed turf cup, with BSP inlet threads, and 15 nozzle options	
I-80-04-SS-ON-B = 10 cm pop-up	Full-circle, opposing nozzle, stainless steel riser, check valve, with BSP inlet threads, and 15 nozzle options	23 to 53 = Factory-installed nozzle number, no nozzle pack
I-80-04-SS-ON-TC-B = 10 cm pop-up with turf cup	Full-circle, opposing nozzle, stainless steel riser, check valve, factory-installed turf cup, with BSP inlet threads, and 15 nozzle options	

Examples:

I-80-04-SS-B-25 = 10 cm pop-up, adjustable arc, stainless steel riser, check valve, BSP inlet threads, and factory-installed 25 nozzle















I-80-04-SS-ON-B-38 = 10 cm pop-up, stainless steel riser, check valve, opposing nozzle full-circle, BSP inlet threads, and factory-installed 38 nozzle

I-80-04-SS-ON-TC-B-48 = 10 cm pop-up, stainless steel riser, check valve, opposing nozzle full-circle, factory-installed turf cup, BSP inlet threads, and factory-installed 48 nozzle

I-80 NOZZLE PERFORMANCE DATA										
Nozzle Set			Pressure		Radius	Flow		Precip mm/hr		
			bar	kPa	m	m ³ /hr	l/min	■	▲	
Orange 803603 ●	 23 Green	Lt. Green  315313	3.4	344	19.8	4.59	76.5	11.7	13.5	
			4.1	413	20.1	5.02	83.7	12.4	14.3	
			4.5	450	20.4	5.43	90.5	13.0	15.0	
			4.8	482	20.4	5.50	91.6	13.2	15.2	
			5.5	551	21.0	5.88	98.0	13.3	15.4	
Orange 803603 ●	 25 Blue	Lt. Green  315313	4.5	450	21.6	6.43	107.1	13.7	15.8	
			4.8	482	21.9	6.66	110.9	13.8	16.0	
			5.5	551	22.3	7.16	119.2	14.5	16.7	
			6.2	620	22.6	7.59	126.4	14.9	17.2	
			6.9	689	22.9	8.04	134.0	15.4	17.8	
Orange 803603 ●	 33 Grey	Lt. Green  315313	4.5	450	21.9	6.95	115.8	14.4	16.7	
			4.8	482	22.3	7.18	119.6	14.5	16.7	
			5.5	551	22.9	7.70	128.3	14.7	17.0	
			6.2	620	23.5	8.13	135.5	14.8	17.0	
			6.9	689	24.1	8.61	143.5	14.8	17.1	
Orange 803603 ●	 38 Red	Lt. Green  315313	4.5	450	23.2	7.93	132.1	14.8	17.1	
			4.8	482	23.8	8.22	137.0	14.5	16.8	
			5.5	551	24.4	8.88	148.0	14.9	17.2	
			6.2	620	25.0	9.36	156.0	15.0	17.3	
			6.9	689	25.6	9.88	164.7	15.1	17.4	
Orange 803603 ●	 43 Dk. Brown	Lt. Green  315313	4.8	482	24.7	9.36	156.0	15.4	17.7	
			5.5	551	25.3	9.88	164.7	15.4	17.8	
			6.2	620	26.2	10.49	174.9	15.3	17.6	
			6.9	689	27.1	11.06	184.3	15.0	17.4	
			6.9	689	27.1	11.06	184.3	15.0	17.4	
Orange 803603 ●	 48 Dk. Green	Lt. Green  315313	4.8	482	25.3	10.52	175.3	16.4	19.0	
			5.5	551	25.9	10.99	183.2	16.4	18.9	
			6.2	620	27.1	11.74	195.7	16.0	18.4	
			6.9	689	27.7	12.38	206.3	16.1	18.6	
			6.9	689	27.7	12.38	206.3	16.1	18.6	
Orange 803603 ●	 53 Dk. Blue	Lt. Green  315313	4.8	482	26.5	11.52	191.9	16.4	18.9	
			5.5	551	27.1	12.06	201.0	16.4	18.9	
			6.2	620	28.0	12.81	213.5	16.3	18.8	
			6.9	689	28.7	13.54	225.6	16.5	19.0	
			6.9	689	28.7	13.54	225.6	16.5	19.0	

● = Nozzle Plug P/N 315300 installed in the back side of the nozzle housing.

* Complies to ASAE standard. All precipitation rates calculated for 360° operation. All triangular rates are equilateral.

I-80-ON NOZZLE PERFORMANCE DATA*										
Nozzle Set			Pressure		Radius	Flow		Precip mm/hr		
			bar	kPa	m	m ³ /hr	l/min	■	▲	
Tan 803611 ●	 23 Green	Lt. Blue  315311	3.4	344	19.2	4.91	81.8	13.3	15.4	
			4.1	413	19.8	5.22	87.1	13.3	15.4	
			4.5	450	20.1	5.45	90.8	13.5	15.6	
			4.8	482	20.4	5.66	94.3	13.6	15.7	
			5.5	551	20.7	6.04	100.7	14.1	16.2	
Tan 803611 ●	 25 Blue	Lt. Blue  315311	4.5	450	21.6	6.50	108.3	13.9	16.0	
			4.8	482	22.3	6.75	112.5	13.6	15.7	
			5.5	551	22.6	7.19	119.8	14.1	16.3	
			6.2	620	22.9	7.65	127.5	14.6	16.9	
			6.9	689	23.5	8.12	135.3	14.7	17.0	
Tan 803611 ●	 33 Grey	Lt. Blue  315311	4.5	450	22.6	7.02	117.0	13.8	15.9	
			4.8	482	22.9	7.27	121.1	13.9	16.1	
			5.5	551	23.5	7.77	129.5	14.1	16.3	
			6.2	620	24.1	8.22	137.0	14.2	16.4	
			6.9	689	24.7	8.68	144.6	14.2	16.4	
Tan 803611 ●	 38 Red	Lt. Blue  315311	4.5	450	23.5	7.97	132.9	14.5	16.7	
			4.8	482	24.1	8.31	138.5	14.3	16.6	
			5.5	551	25.0	8.84	147.3	14.1	16.3	
			6.2	620	25.6	9.38	156.3	14.3	16.5	
			6.9	689	26.5	9.90	165.0	14.1	16.3	
Tan 803611 ●	 43 Dk. Brown	Lt. Blue  315311	4.8	482	25.3	9.38	156.3	14.7	16.9	
			5.5	551	25.9	9.90	165.0	14.8	17.0	
			6.2	620	26.5	10.52	175.3	15.0	17.3	
			6.9	689	27.1	11.09	184.7	15.1	17.4	
			6.9	689	27.1	11.09	184.7	15.1	17.4	
Tan 803611 ●	 48 Dk. Green	Lt. Blue  315311	4.8	482	27.4	10.65	177.5	14.2	16.3	
			5.5	551	28.0	11.11	185.1	14.1	16.3	
			6.2	620	28.7	11.46	191.0	14.0	16.1	
			6.9	689	29.3	12.15	202.5	14.2	16.4	
			6.9	689	29.3	12.15	202.5	14.2	16.4	
Tan 803611 ●	 53 Dk. Blue	Lt. Blue  315311	4.8	482	27.7	11.31	188.5	14.7	17.0	
			5.5	551	28.3	11.86	197.7	14.8	17.0	
			6.2	620	29.0	12.61	210.1	15.0	17.4	
			6.9	689	29.6	13.29	221.4	15.2	17.6	
			6.9	689	29.6	13.29	221.4	15.2	17.6	

I-80 NOZZLES



I-90

Radius: **22.3 to 31.4 m**
Flow: **6.7 to 19.04 m³/hr; 111.7 to 317.2 l/min**

The robust I-90 Rotor is built for long-distance natural turf applications in large parks, open spaces, and sports fields.

ROTORS

KEY BENEFITS

- PressurePort™ Technology, forward-facing triple nozzles (I-90), opposing triple nozzles (I-90-ON) create exceptional nozzle uniformity in part- and full-circle applications
- Part- and full-circle in one model provides flexible installation options and reduces inventory (I-90)
- Drain Check Valve prevents low-head drainage (up to 2 m of elevation)

OPERATING SPECIFICATIONS

- I-90 nozzle choices: 8
- Radius I-90 ADV: 20.1 to 29.6 m
- Radius I-90 36V: 22.3 to 31.4 m
- Flow I-90 ADV: 6.7 to 19.04 m³/hr; 111.7
- Flow I-90 36V: 6.93 to 18.92 m³/hr; 115.5 to 315.3 l/min
- Recommended pressure range: 5.5 to 8.3 bar; 550 to 830 kPa
- Operating pressure range: 5.5 to 8.3 bar; 550 to 830 kPa
- Precipitation rate: 19 mm/hr approximately
- Warranty period: 5 years

FACTORY-INSTALLED OPTIONS

- Reclaimed water ID

USER-INSTALLED OPTIONS

- Rubber Cover Kit P/N: 234200
- Turf Cup Kit P/N: 467955
- Prefabricated PVC 1½" (40 mm) HSJ Swing Joints



I-90
Overall height: ADV/36V: 28 cm
Pop-up height: 8 cm
Exposed diameter: 9 cm
Inlet size: 1½" (40 mm) BSP



Turf Cup Kit
P/N 467955



Rubber Cover Kits
P/N 234200



I-90 Reclaimed

Available as a factory-installed option on all models

I-90 - SPECIFICATION BUILDER: ORDER 1 + 2 + 3 + 4

1 Model	2 Standard Features	3 Feature Options	4 Nozzle Options
I-90 = 8 cm pop-up	Plastic riser, check valve, and 8 nozzles	ADV-B = Adjustable arc, with BSP inlet threads ARV-B = Adjustable arc and reclaimed water ID, with BSP inlet threads 36V-B = Full-circle, opposing nozzles, with BSP inlet threads 3RV-B = Full-circle, opposing nozzles and reclaimed water ID, with BSP inlet threads	25 to 73 = Factory-installed nozzle number

Examples:

I-90-ADV-B = 8 cm pop-up, adjustable arc, with BSP inlet threads

I-90-36V-B-43 = 8 cm pop-up, full-circle, opposing nozzles, with BSP inlet threads, and 43 nozzle

I-90-3RV-B-63 = 8 cm pop-up, full-circle, opposing nozzles, reclaimed water ID, with BSP inlet threads, and 63 nozzle

I-90-ADV NOZZLE PERFORMANCE DATA							
Nozzle	Pressure		Radius m	Flow		Precip mm/hr	
	bar	kPa		m ³ /hr	l/min	■	▲
25 Lt. Blue	5.5	550	20.1	6.70	111.7	33.1	38.2
	6.0	600	20.4	7.16	119.2	34.3	39.6
	7.0	700	20.7	7.54	125.7	35.1	40.5
	7.5	750	21.0	8.09	134.8	36.6	42.2
33 Grey	5.5	550	20.7	8.22	137.0	38.3	44.2
	6.0	600	21.0	8.68	144.6	39.2	45.3
	7.0	700	21.3	9.18	152.9	40.3	46.6
	7.5	750	21.6	9.68	161.3	41.3	47.7
38 Red	5.5	550	21.9	9.22	153.7	38.3	44.2
	6.0	600	22.3	9.77	162.8	39.5	45.6
	7.0	700	22.9	10.31	171.9	39.5	45.6
	7.5	750	23.2	10.81	180.2	40.3	46.5
43 Dk. Brown	5.5	550	22.6	10.47	174.5	41.2	47.5
	6.0	600	22.6	11.02	183.6	43.3	50.0
	7.0	700	22.9	11.52	191.9	44.1	50.9
	7.5	750	23.5	12.13	202.1	44.0	50.9
48 Dk. Green	5.5	550	23.5	11.40	190.0	41.4	47.8
	6.0	600	24.1	11.95	199.1	41.2	47.6
	7.0	700	24.7	12.52	208.6	41.1	47.4
	7.5	750	25.0	13.06	217.7	41.8	48.3
53 Dk. Blue*	5.5	550	24.7	12.47	207.8	40.9	47.2
	6.0	600	25.6	12.99	216.5	39.6	45.8
	7.0	700	26.2	13.52	225.2	39.3	45.4
	7.5	750	26.5	14.11	235.1	40.1	46.3
	8.0	800	26.8	14.63	243.8	40.7	47.0
63 Black	5.5	550	26.2	14.15	235.8	41.2	47.6
	6.0	600	26.8	14.88	247.9	41.4	47.8
	7.0	700	27.4	15.67	261.2	41.7	48.1
	7.5	750	27.7	16.33	272.2	42.5	49.0
	8.0	800	28.0	16.97	282.8	43.2	49.8
73 Orange	5.5	550	27.1	16.51	275.2	44.9	51.8
	6.0	600	27.7	17.13	285.4	44.5	51.4
	7.0	700	28.3	17.74	295.6	44.2	51.0
	7.5	750	29.0	18.38	306.2	43.8	50.6
	8.0	800	29.6	19.04	317.2	43.5	50.3

* Factory-installed nozzle

Notes:

Precipitation rates for ADV models are calculated for 180° operation. Precipitation rates for 36V models are calculated for 360° operation. All triangular rates are equilateral. Complies to ASAE standard.

I-90-36V NOZZLE PERFORMANCE DATA							
Nozzle	Pressure		Radius m	Flow		Precip mm/hr	
	bar	kPa		m ³ /hr	l/min	■	▲
25 Lt. Blue	5.5	550	22.3	6.93	115.5	14.0	16.2
	6.0	600	22.9	7.36	122.6	14.1	16.3
	7.0	700	23.2	7.79	129.8	14.5	16.8
	7.5	750	23.8	8.29	138.2	14.7	16.9
33 Grey	5.5	550	23.5	8.25	137.4	15.0	17.3
	6.0	600	23.8	8.72	145.4	15.4	17.8
	7.0	700	24.4	9.22	153.7	15.5	17.9
	7.5	750	24.7	9.70	161.6	15.9	18.4
38 Red	5.5	550	24.4	9.22	153.7	15.5	17.9
	6.0	600	25.0	9.75	162.4	15.6	18.0
	7.0	700	25.3	10.29	171.5	16.1	18.6
	7.5	750	25.9	10.84	180.6	16.1	18.6
43 Dk. Brown	5.5	550	25.3	10.49	174.9	16.4	18.9
	6.0	600	25.6	11.04	184.0	16.8	19.4
	7.0	700	25.9	11.56	192.7	17.2	19.9
	7.5	750	26.2	12.13	202.1	17.7	20.4
48 Dk. Green	5.5	550	26.2	11.27	187.8	16.4	18.9
	6.0	600	27.1	11.93	198.7	16.2	18.7
	7.0	700	27.4	12.45	207.4	16.5	19.1
	7.5	750	27.7	13.02	216.9	16.9	19.5
53 Dk. Blue*	5.5	550	27.1	12.31	205.2	16.7	19.3
	6.0	600	27.4	12.88	214.6	17.1	19.8
	7.0	700	28.0	13.45	224.1	17.1	19.7
	7.5	750	28.3	14.02	233.6	17.4	20.1
	8.0	800	28.7	14.58	243.0	17.8	20.5
63 Black	5.5	550	28.0	14.36	239.2	18.3	21.1
	6.0	600	28.7	14.97	249.5	18.2	21.1
	7.0	700	29.3	15.76	262.7	18.4	21.3
	7.5	750	29.6	16.36	272.5	18.7	21.6
	8.0	800	29.9	17.01	283.5	19.1	22.0
73 Orange	5.5	550	29.3	16.38	272.9	19.1	22.1
	6.0	600	29.9	17.04	283.9	19.1	22.0
	7.0	700	30.2	17.67	294.5	19.4	22.4
	7.5	750	31.1	18.29	304.7	18.9	21.8
	8.0	800	31.4	18.92	315.3	19.2	22.2



I-90



HSJ SWING JOINTS

With swivel ells on both ends, HSJ Swing Joints easily adjust sprinklers to proper height and position in any configuration.

ROTORS

KEY BENEFITS













- Strength, longevity and contamination resistance
 - Prefabricated PVC design with O-ring seals
- Configurations to meet every installation requirement
 - Available in all popular inlet and outlet configurations
 - Choose from 20 cm, 30 cm, or 46 cm lay arm lengths
 - Single top-out or triple top-out designs

Swing Joints

- HSJ-0 = Model ¾"
- HSJ-1 = Model 1" (25 mm)
- HSJ-2 = Model 1¼" (30 mm)
- HSJ-3 = Model 1½" (40 mm)



SWING JOINT – SPECIFICATION BUILDER: ORDER 1 + 2 + 3 + 4 + 5

1 Model	2 Inlet Type (from pipe fitting)	3 Outlet Type (to sprinkler inlet)	4 Outlet Style	5 Lay Length
HSJ-0 = ¾" commercial Swing Joint HSJ-1 = 1" (25 mm) heavy-duty Swing Joint HSJ-2 = 1¼" (30 mm) heavy-duty Swing Joint HSJ-3 = 1½" (40 mm) heavy-duty Swing Joint	3 = Male NPT  4 = Male Acme*  6 = Male BSP**  7 = Spigot, 10 cm long**  M = Main Acme H-connection *** P = Main Acme V-connection	0 = Male Acme  2 = Male NPT  5 = Male BSP (not available in HSJ-0)  6 = Enlarging to 1½" (40 mm) male BSP* 8 = Enlarging to 1½" (40 mm) male Acme* A = Enlarging/reducing to 30 mm male Acme**	2 = Single top-out  4 = Triple top-out 	8 = 20 cm lay arm*  12 = 30 cm lay arm  18 = 46 cm lay arm**  * HSJ-0 only ** Not available in HSJ-0

Example:
 HSJ-1-3-2-2-12 = HSJ 1" (25 mm) heavy-duty Swing Joint, 1" (25 mm) NPT inlet, 1" (25 mm) male NPT single top-out outlet, 30 cm lay arm length

SnapLok is a trademark of LASCO Fittings Inc.

SNAPLOK™ COMBO KITS







These kits are designed for applications that demand sturdy installation due to frequent Quick Coupler use.

KEY BENEFITS

- Highly effective solution for Quick Coupler stabilisation
- SnapLok design includes:
 - Heavy-duty PVC and brass outlet construction
 - Anti-rotation coupler locking feature
 - Accommodates both rebar and pipe stabilisation
- Solves common quick-coupler stabilisation and unthreading concerns
 - Unique SnapLok outlet with integrated brass thread outlet
- See the HSJ Swing Joints on [page 42](#)



SNAPLOK COMBO KITS - SPECIFICATION BUILDER: ORDER 1 + 2 + 3 + 4 + 5

1 Model	2 Inlet Type (from pipe fitting)	3 Outlet Type (to sprinkler inlet)	4 Outlet Style	5 Lay Length
HSJ-1 = 1" (25 mm) heavy-duty Swing Joint	6 = Male BSP  2 = Short spigot 	S = 1" Male brass NPT SnapLok  T = ¾" Male brass NPT/BSP SnapLok U = 1" (25 mm) Male brass BSP SnapLok 	2 = Single top-out 	12 = 30 cm lay arm  18 = 46 cm lay arm 

Example:

HSJ-1-6-S-2-12 = HSJ 1" (25 mm) heavy-duty Swing Joint, 1" (25 mm) BSP inlet, 1" (25 mm) male brass outlet, single top-out, 30 cm lay arm length

HCV CHECK VALVES

Eliminate low-head drainage for both rotor and spray shrub systems with the adjustable HCV Check Valves.

KEY BENEFITS

- Adjustment access from top of valve
- Adjusts to compensate for elevational changes up to 11 m
- Variety of inlet and outlet options reduces need for additional fittings
- Meets Schedule 80 specifications for durability under high pressure
- Pressure loss charts for HCV products on [page 219](#)

HCV CHECK VALVES	
Model	Description
HC-50F-50F	½" female inlet x ½" female outlet
HC-50F-50M	½" female inlet x ½" male outlet
HC-75F-75M	¾" female inlet x ¾" male outlet



HCV Check Valves
Overall height: 7.5 cm

ST SYSTEMS





ST-90-B

The ST-90-B Synthetic Turf Rotor is designed for installation in natural turf adjacent to the playing surface — the perfect solution for small and midsize fields.

KEY BENEFITS

- Arc setting: 40° to 360°
- QuickCheck™ Arc Mechanism
- Through-the-top arc adjustment
- Water-lubricated gear drive
- Factory-installed rubber logo cap
- Nozzle trajectory: 22.5°

OPERATING SPECIFICATIONS

- Radius: 31.4 m to 36.6 m
- Flow: 16.9 to 20.9 m³/hr; 282 to 348 l/min
- Operating pressure range: 6.9 to 8.3 bar; 690 to 830 kPa
- Precipitation rate: 35 mm/hr approximately
- Warranty period: 5 years for component parts

USER-INSTALLED OPTIONS

- Rubber Cover Kit ST-90: P/N 234200SP

ST ROTOR	
Model	Description
ST-90-B-XX	8 cm pop-up, jar-top cap, adjustable arc, plastic riser, and BSP inlet threads, 73 or 83 preinstalled nozzle



ST-90-B*
 Overall height: 29 cm
 Pop-up height: 8 cm
 Diameter: 14 cm
 Inlet size: 1½" (40 mm) BSP

* Not for use with the ST Vault

ST-90-B NOZZLE PERFORMANCE DATA

Nozzle	Pressure		Radius m	Flow		Precip mm/hr	
	bar	kPa		m ³ /hr	l/min	■	▲
73 ●	7.0	700	31.4	16.9	282	34.3	39.6
	7.5	750	33.2	17.5	291	31.7	36.6
Orange	8.0	800	35.1	18.1	301	29.4	34.0
	7.0	700	34.1	19.1	319	32.8	37.9
83 ●	7.5	750	35.4	20.0	333	32.0	37.0
	8.0	800	36.6	20.9	348	31.2	36.1

Notes:

All precipitation rates calculated for 180° operation.
 For precipitation rate of a 360° sprinkler, divide by 2.

Requires minimum 7.0 bar; 700 kPa dynamic pressure supplied to Swing Joint inlet.

HIGH-FLOW SWING JOINTS

These durable Swing Joints are easy to position and ensure correct rotor installation height.

KEY BENEFITS

- Heavy-duty, high-flow Swing Joints with O-ring seals
- HSJ-4 for high-flow I-90 and ST-90 Rotors with 2" (50 mm) inlets

High-Flow Swing Joints
 HSJ-4 = 50 mm model



HSJ HIGH-FLOW SWING JOINT - SPECIFICATION BUILDER: ORDER 1 + 2 + 3 + 4

1 Model	2 Inlet Type (from pipe fitting)	3 Outlet Type (to sprinkler inlet)	4 Outlet Style	5 Lay Length
HSJ-4 = 50 mm heavy-duty Swing Joint	6 = 2" (50 mm) male BSP, horizontal side connection	D = 1½" (40 mm) male BSP	2 = Single top-out	12 = 12" (30 cm) lay arm

Example:

HSJ-4-6-D-2-12 = HSJ 50 mm heavy-duty Swing Joint, 50 mm male BSP horizontal side connection to piping, 40 mm male BSP outlet to sprinkler, single top-out, and 30 cm lay arm

ST-1200-BR

The cost-effective ST-1200-BR Synthetic Turf Rotor is the ideal riser-mounted solution for pastures, corrals, arenas, dust control, and wash-down watering.

KEY BENEFITS

- Nozzle choices: 5 (included)
- Standard nozzle: 12
- Nozzle range: 10 to 18
- Nozzle trajectory: 22.5°
- Isolated, grease-lubricated gear drive
- Nozzle barrels: short and long (included)
- Movable stops (left and right) arc adjustment
- Arc setting: 40° to non-reversing 360°
- Ratcheting nozzle turret

OPERATING SPECIFICATIONS

- Radius: 20.4 m to 35.1 m
- Flow: 6.13 to 29.76 m³/hr; 102.1 to 495.9 l/min
- Operating pressure range: 2.0 to 6.0 bar; 200 to 600 kPa



ST-1200-BR

Overall height: 30 cm
Overall length: 30 cm (Long Barrel)
Overall width: 10 cm
Inlet size: 1½" (40 mm) BSP

*Use P/N 241401SP 1½" (40 mm) male spigot x 1½" (40 mm) BSP adapter if needed

Included

Short and long barrels

ST-1200-BR NOZZLE PERFORMANCE DATA

Nozzle	Pressure		Radius m	Flow		Precip in/hr	
	Bar	kPa		m ³ /hr	l/min	■	▲
10 ●	2.0	200	20.4	6.13	102.2	29.4	34.0
	3.0	300	22.9	7.45	124.2	28.5	32.9
	4.0	400	25.9	8.65	144.2	25.8	29.8
	5.0	500	27.4	9.88	164.7	26.3	30.3
12 ●	2.0	200	20.7	7.63	127.2	35.5	41.0
	3.0	300	23.8	9.36	156.0	33.1	38.2
	4.0	400	26.8	10.81	180.2	30.1	34.7
	5.0	500	29.9	12.06	201.0	27.0	31.2
14 ●	2.0	200	21.3	10.38	173.0	45.6	52.7
	3.0	300	26.2	12.72	212.0	37.0	42.8
	4.0	400	30.5	14.70	244.9	31.6	36.5
	5.0	500	33.5	16.47	274.4	29.3	33.8
16 ●	2.0	200	21.9	13.52	225.2	56.1	64.8
	3.0	300	28.3	16.58	276.3	41.3	47.7
	4.0	400	31.4	19.15	319.1	38.9	44.9
	5.0	500	35.4	18.38	306.2	29.4	33.9
18 ●	3.0	300	29.0	21.01	350.1	50.1	57.9
	4.0	400	31.7	24.31	405.0	48.4	55.9
	5.0	500	33.8	27.15	452.4	47.4	54.8
	6.0	600	35.1	29.76	495.9	48.4	55.9

ST-1200-BR Rotor Installed



ST-1600-HS-BR

In addition to synthetic turf, this heavy-duty rotor is designed for irrigating pastures, horse arenas, dust control, and natural turf areas.

KEY BENEFITS

- Nozzle choices: 6
- Standard nozzle: 20
- Nozzle range: 16 to 26
- Nozzle trajectory: 25°
- Movable stops with left and right arc adjustment
- Arc setting: 40° to non-reversing 360°
- Ratcheting nozzle turret

OPERATING SPECIFICATIONS

- Radius: 32.5 to 50.3 m
- Flow: 21.8 to 74.2 m³/hr; 364 to 1,237 l/min
- Operating pressure range: 4.0 to 8.0 bar; 400 to 800 kPa
- Precipitation rate: 60 mm/hr approximately
- Warranty period: 5 years for component parts



ST-1600-HS-BR (High-Speed)
(Riser-Mounted Model)
Overall height: 22 cm
Diameter: 21 cm
Inlet size: 2" (50 mm) BSP*

*Use P/N 241400SP 2" (50 mm) male spigot x 2" (50 mm) male BSP adapter if needed

ST-1600-HS-BR NOZZLE PERFORMANCE DATA*

Nozzle	Pressure		Radius m	Flow		Precip mm/hr	
	bar	kPa		m ³ /hr	l/min	■	▲
16 ●	4.0	400	32.5	21.8	364	41.4	47.8
	5.0	500	35.0	24.4	406	39.8	45.9
	6.0	600	37.0	26.8	446	39.1	45.1
	7.0	700	39.0	28.9	482	38.0	43.9
	8.0	800	41.0	31.2	520	37.1	42.9
18 ●	4.0	400	34.0	24.3	405	42.0	48.6
	5.0	500	37.0	27.1	452	39.6	45.8
	6.0	600	39.0	29.8	496	39.1	45.2
	7.0	700	40.5	32.1	535	39.1	45.2
	8.0	800	43.0	34.8	580	37.6	43.5
20 ●	4.0	400	35.0	32.7	545	53.4	61.7
	5.0	500	39.0	36.5	609	48.1	55.5
	6.0	600	43.0	40.1	668	43.4	50.1
	7.0	700	44.0	43.3	721	44.7	51.6
	8.0	800	45.0	46.4	773	45.8	52.9
22 ●	4.0	400	36.0	38.9	649	60.1	69.4
	5.0	500	39.5	43.6	726	55.8	64.5
	6.0	600	44.0	47.7	795	49.3	56.9
	7.0	700	47.0	51.5	859	46.7	53.9
	8.0	800	48.0	55.2	920	47.9	55.3
24 ●	4.0	400	37.0	45.9	765	67.1	77.4
	5.0	500	40.5	51.3	855	62.6	72.2
	6.0	600	45.0	56.2	937	55.5	64.1
	7.0	700	47.5	60.7	1012	53.8	62.2
	8.0	800	48.7	65.0	1084	54.9	63.3
26 ●	4.0	400	38.4	53.0	883	71.8	82.9
	5.0	500	41.4	59.2	986	68.8	79.5
	6.0	600	46.0	64.6	1077	61.0	70.4
	7.0	700	48.7	69.7	1162	58.6	67.7
	8.0	800	50.3	74.2	1237	58.7	67.8

*All radius measurements are taken at standard rotation speeds. Slowing rotation to the minimum rotation speed will add 3+ meters to the radius.

ST-1600-HS-BR Rotor Installed



ST-1700-V

This ST System includes a valve-in-head design for faster installation and maintenance.

KEY BENEFITS

- Nozzle choices: 5 ranging from nozzles 16 to 24
- Nozzle trajectory: 25°
- Total-Top-Service (TTS) design provides convenient no-dig servicing
- Valve-in-head configuration simplifies installation
- Isolated, grease-lubricated gear drive provides smooth operation
- Arc adjustment: movable stops for left/right arc adjustment

OPERATING SPECIFICATIONS

- Radius: 32 m to 48 m
- Flow: 21.0 to 58.8 m³/hr; 350 to 980 l/min
- Operating pressure range: 4.0 to 8.0 bar; 400 to 800 kPa
- Arc setting: 40° to non-reversing 360°
- Speed of rotation: 80 seconds at 6.0 bar; 600 kPa (single 180° sweep)
- Precipitation rate: 45 mm/hr approximately
- Warranty period: 5 years for component parts

USER-INSTALLED OPTIONS

- Infill Barrier System Rubber Cover Kit: P/N ST-IBS-1700
- Short-Radius Nozzle Kit: P/N 959900
- Adapter (if needed), 2" (50 mm) male spigot x 2" (50 mm) male BSP: P/N 241400SP



ST-1700-V

Overall height: 68 cm
Pop-up height: 13 cm
Top: 33 cm x 39 cm
Inlet size: 2" (50 mm) BSP*



ST-1700-V Valve Tool

P/N 10000100SP
For installation and removal of inlet valve



Snap Ring Removal Tool

P/N 251000SP



Infill Barrier System Rubber Cover Kit

P/N STIBS1700

ST-1700-V NOZZLE PERFORMANCE DATA							
Nozzle	Pressure		Radius	Flow		Precip mm/hr	
	bar	kPa		m	m ³ /hr	l/min	■
16 ●	4.0	400	32.0	21.0	350	41.0	47.3
	5.0	500	35.0	22.7	379	37.1	42.8
	6.0	600	37.0	25.9	432	37.8	43.7
	7.0	700	38.5	28.1	469	38.0	43.9
	8.0	800	40.0	30.4	508	38.1	43.9
18 ●	4.0	400	34.0	24.3	405	42.0	48.5
	5.0	500	36.5	26.1	435	39.2	45.3
	6.0	600	38.5	28.8	481	38.9	44.9
	7.0	700	40.0	31.1	519	38.9	44.9
	8.0	800	42.0	33.8	564	38.3	44.3
20 ●	4.0	400	35.0	30.4	508	49.7	57.4
	5.0	500	39.0	34.3	572	45.1	52.0
	6.0	600	41.0	37.2	621	44.3	51.1
	7.0	700	43.0	40.9	681	44.2	51.0
	8.0	800	45.0	44.0	733	43.4	50.1
22 ●	4.0	400	35.5	34.9	582	55.4	63.9
	5.0	500	39.0	39.5	659	51.9	60.0
	6.0	600	43.0	42.9	715	46.4	53.6
	7.0	700	45.5	46.8	780	45.2	52.2
	8.0	800	47.0	50.4	841	45.7	52.7
24 ●	4.0	400	37.0	40.2	671	58.8	67.9
	5.0	500	40.5	45.6	761	55.6	64.2
	6.0	600	44.0	50.4	840	52.1	60.1
	7.0	700	47.0	54.5	908	49.3	57.0
	8.0	800	48.0	58.8	980	51.0	58.9

STG-900-KIT-B / STG-900

This top-quality, long-range system is specially designed for synthetic turf sports field irrigation.

KEY BENEFITS

- Arc setting: 40° to 360°
- QuickCheck™ Arc Mechanism
- Through-the-top arc adjustment
- Water-lubricated gear drive
- Factory-installed rubber logo cap
- Nozzle trajectory: 22.5°

OPERATING SPECIFICATIONS

- Radius: 31.4 m to 36.6 m
- Flow: 16.9 to 20.9 m³/hr; 282 to 348 l/min
- Operating pressure range: 6.9 to 8.3 bar; 690 to 830 kPa
- Precipitation rate: 35 mm/hr approximately
- Warranty period: 5 years for component parts

USER-INSTALLED OPTIONS

- Rubber Cover Kit STG-900: P/N 473900SP



STG-900*

Overall height: 36 cm
Pop-up height: 8 cm
Diameter: 20 cm
Inlet size: 1½" (40 mm) Acme

*For use with the ST-173026-B Vault

STG-900-KIT-B

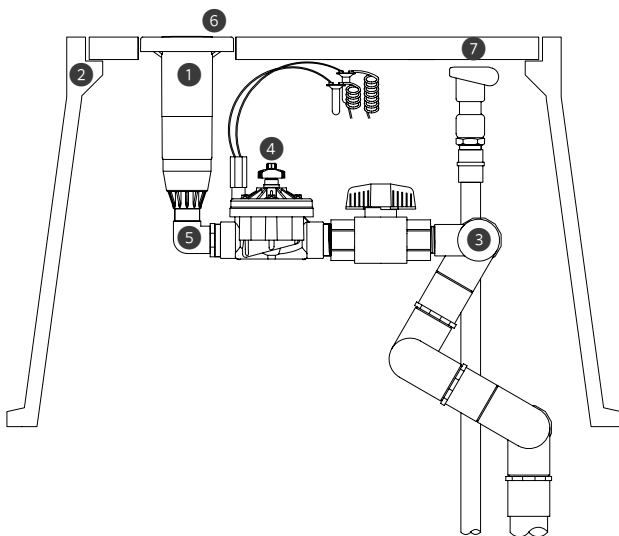

STG-900-KIT-B COMPONENTS

FIGURE	COMPONENTS	QTY	DESCRIPTION
1	STG-900-83	1	Pop-up, top serviceable, adjustable arc (40°–360°), 1½" (40 mm) Acme inlet
2	ST-173026-B	1	Composite vault, pre-cast hole for rotor and quick coupler
3	ST-2008-VA	1	Vertical alignment PVC Swing Joint, seven pivot points, 2" (50 mm) female slip inlet, 1½" (40 mm) female Acme outlet
4	ST-VBVF-K	1	ICV-151G valve, manifold ball valve, 1½" (40 mm) Acme inlet, 1½" (40 mm) Acme outlet
5	239800	1	1½" (40 mm) elbow, female Acme to male Acme, connects STG-900 rotor to ST-VBVF-K
6	473900SP	1	STG-900 rubber cover kit
7	HQ-5-RC-BSP	1	Quick coupler, 1" BSP inlet, 1¼" outlet for key

STG-900 Rotor



STG-900 NOZZLE PERFORMANCE DATA

Nozzle	Pressure		Radius m	Flow		Precip mm/hr	
	bar	kPa		m ³ /hr	l/min	■	▲
73 ●	7.0	700	31.4	16.9	282	34.3	39.6
	7.5	750	33.2	17.5	291	31.7	36.6
Orange	8.0	800	35.1	18.1	301	29.4	34.0
83 ●	7.0	700	34.1	19.1	319	32.8	37.9
	7.5	750	35.4	20.0	333	32.0	37.0
Tan	8.0	800	36.6	20.9	348	31.2	36.1

Notes:

All precipitation rates are calculated for 180° operation.
For the precipitation rate of a 360° sprinkler, divide by 2.

Requires minimum 7.0 bar; 700 kPa dynamic pressure supplied to the Swing Joint inlet.

ST SWING JOINTS

Multiaxis 22 bar; 2,200 kPa rated vertical alignment PVC Swing Joints with seven O-ring sealed pivot points allow the rotor to be perfectly placed within the ST Vault's cover set opening.

ST-2008-VA: 2" (50 mm) for STG-900

Inlet: 2" (50 mm) slip*
Outlet: 1½" (40 mm) Acme

*Use P/N 241400 adapter to connect to male BSP threads

Adapter fitting 239300
Connects 239800 elbow fitting to STG-900 Rotor with Acme inlet



ST VALVE SETS

Heavy-duty control valves are configured to complement the ST Rotors and ST Vaults.

ST-VBVF-K: For STG-900-KIT-B

Valve: 1½" (40 mm) NPT ICV
Ball valve: 22 bar (2,200 kPa) rating
Inlet: 1½" (40 mm) Acme
Outlet: 1½" (40 mm) Acme

Low-pressure-loss design: 0.7 bar; 70 kPa at 22.7 m³/hr; 378 l/min from Swing Joint inlet through to rotor
Includes: 1½" (40 mm) connection fittings



ST VAULTS

Heavy-duty tapered fibreglass and polymer-concrete construction with pre-cast holes for rotor and quick coupler valve.

ST-173026-B for STG-900-KIT-B includes 50 mm thick, 3-piece cover set

Main cover: 43 cm x 76 cm
Overall height: 66 cm
Body weight: 47 kg
Total weight: 73 kg
Base pad: 68 cm x 104 cm
Quick-access ports: 1



① Quick Coupler

All ST Vaults include handy quick-access ports. Quick couplers provide a convenient source of water for washing down spills and water-soluble paint. The integrated in-vault design eliminates the need for additional quick-coupler enclosures.

ST-1600-KIT-B / ST-1600-HS-B

This all-in-one solution offers unmatched cleaning, cooling, and flushing capabilities to prepare synthetic sports fields for play.

KEY BENEFITS

- Nozzle choices: 6
- Standard nozzle: 20
- Nozzle range: 16 to 26
- Nozzle trajectory: 25°
- Isolated, grease-lubricated gear drive
- Movable stops (left and right) arc adjustment
- Arc setting: 40° to non-reversing 360°
- Ratcheting nozzle turret
- Adjustable speed of rotation: 0 to 65 seconds (high-speed models, 180° at 8 bar; 800 kPa)

OPERATING SPECIFICATIONS

- Radius: 32.5 to 50.3 m
- Flow: 21.8 to 74.2 m³/hr; 364 to 1,237 l/min
- Operating pressure range: 4 to 8 bar; 400 to 800 kPa
- Precipitation rate: 60 mm/hr approximately
- Warranty period: 5 years for component parts

USER-INSTALLED OPTIONS

- Simulated concrete cover for attachment to the top of the flattened Infill Barrier System (used with vault): P/N ST-FRP-1600
- ST-approved adhesive for attaching artificial turf, track, or simulated concrete (ST-FRP-1600) to Infill Barrier System: P/N ST-ADH-K
- ST-1600 Short-Radius Nozzle Kit: P/N 959900
- Adapter (if needed), 2" (50 mm) male spigot x 2" (50 mm) male BSP: P/N 241400SP (Not for use with kit)
- DC-Latching Solenoid Kit: P/N ST-LSA

ST-1600-KIT-B

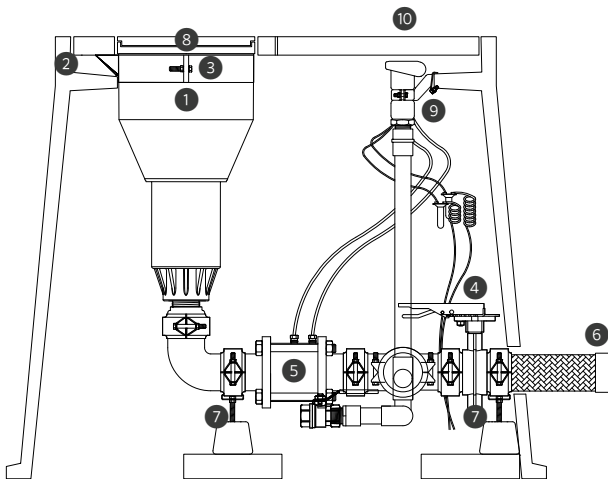

ST-1600-HS-B (High-Speed)

Overall height: 57 cm
Pop-up height: 13 cm
Diameter: 36 cm
Inlet size: 2" (50 mm) BSP*



ST-1600 / ST-1700 Tool

P/N 517600SP
For gear-drive installation and removal

ST-1600-KIT-B COMPONENTS

Figure	Components	Qty	Description
1	ST-1600-HS-B	1	High-speed pop-up, adjustable arc (40° to 360°), 50 mm BSP inlet
2	ST-243636-B	1	Composite vault
3	ST-BKT-1600	1	Rotor vault hanger and grade adjustment bracket for ST-1600-HS-B Rotor
4	ST-BVF30-K	1	Manifold butterfly valve and Victaulic® coupling fitting kit (includes galvanized grooved X male BSP rotor adapter fitting)
5	ST-V30-KV	1	80 mm metal control valve, 80 mm grooved Victaulic inlet/outlet fitting, 91 cm remotely located solenoid and on-off-auto selector manifold
6	ST-H30-K	1	Stainless steel inlet hose, 80 mm female NPT inlet
7	ST-SPT-K	2	Adjustable manifold support stand; two required per vault
8	ST-IBS-1600	1	Infill Barrier System Rubber Cover Kit for ST-1600-HS-B Rotor
9	ST-BKT-QCV	1	Hanger bracket for HQ-5-RC-BSP Quick Coupler
10	HQ-5-RC-BSP	1	Quick Coupler, 25 mm BSP inlet, 32 mm outlet for key

Victaulic is a trademark of Victaulic Company.

ST Infill Barrier System

ST-IBS-1600
Rubber Cover Kit with Infill Barrier System.

ST Adjustable Hanger Bracket

ST-BKT-1600
This bracket supports the rotor within the vault and provides vertical elevation adjustments, allowing for a perfect surface transition.

ST Manifold and Isolation Valve

ST-BVF30-K
Galvanised iron manifold, including 80 mm fitting, isolation valve, and drain valve.



ST H-Block Manifold Supports

ST-SPT-K
Adjustable support stands include a large footprint base made from recycled tire rubber and a 50 mm vertically adjustable support rail (two required under manifold).



ST Flexible Stainless Steel Inlet Hose

ST-H30-K
80 mm ultra-flexible, corrugated, stainless steel hose with stainless steel support braiding.

ST Heavy-Duty, Slow-Opening Valve

ST-V30-KV
Heavy-duty 80 mm ultra-low-pressure-loss valve (0.15 bar; 15 kPa at 65 m³/hr; 1,082 l/min). Includes on-off-auto selector and solenoid (not shown).

ST-1600 NOZZLE PERFORMANCE DATA*

Nozzle	Pressure		Radius m	Flow		Precip mm/hr	
	bar	kPa		m³/hr	l/min	■	▲
16 ● Black	4.0	400	32.5	21.8	364	41.4	47.8
	5.0	500	35.0	24.4	406	39.8	45.9
	6.0	600	37.0	26.8	446	39.1	45.1
	7.0	700	39.0	28.9	482	38.0	43.9
18 ● Black	4.0	400	34.0	24.3	405	42.0	48.6
	5.0	500	37.0	27.1	452	39.6	45.8
	6.0	600	39.0	29.8	496	39.1	45.2
	7.0	700	40.5	32.1	535	39.1	45.2
20 ● Black	4.0	400	35.0	32.7	545	53.4	61.7
	5.0	500	39.0	36.5	609	48.1	55.5
	6.0	600	43.0	40.1	668	43.4	50.1
	7.0	700	44.0	43.3	721	44.7	51.6
22 ● Black	4.0	400	36.0	38.9	649	60.1	69.4
	5.0	500	39.5	43.6	726	55.8	64.5
	6.0	600	44.0	47.7	795	49.3	56.9
	7.0	700	47.0	51.5	859	46.7	53.9
24 ● Black	4.0	400	37.0	45.9	765	67.1	77.4
	5.0	500	40.5	51.3	855	62.6	72.2
	6.0	600	45.0	56.2	937	55.5	64.1
	7.0	700	47.5	60.7	1,012	53.8	62.2
26 ● Black	4.0	400	38.4	53.0	883	71.8	82.9
	5.0	500	41.4	59.2	986	68.8	79.5
	6.0	600	46.0	64.6	1,077	61.0	70.4
	7.0	700	48.7	69.7	1,162	58.6	67.7
	8.0	800	50.3	74.2	1,237	58.7	67.8

Note:
All precipitation rates are calculated for 180° operation.
For the precipitation rate of a 360° sprinkler, divide by 2.
*All radius measurements are taken at standard rotation speeds. Slowing rotation to the minimum rotation speed will add 3+ m to the radius.

SEAMLESS INTEGRATION

Blends in perfectly with the surrounding synthetic surface.



ST VAULTS

The heavy-duty, tapered fibreglass and polymer-concrete construction includes precast holes for the rotor, quick coupler valve, and remote manifold assembly.

Quick couplers provide a convenient source of water for washing down spills and water-soluble paint. The integrated in-vault design eliminates the need for additional quick coupler enclosures.

The ST-V30-KV Valve Kit includes a remotely located on-off-auto selector and solenoid manifold assembly. These convenient features bring valve manual control functions and solenoid splice connections closer to the surface for easy access.

ST-243636-B: Includes 76 mm thick, 4-piece PC cover set

Main cover: 61 cm x 91 cm
Overall height: 91 cm
Body weight: 70 kg
Total weight: 138 kg
Base pad: 106 cm x 122 cm
Quick-access ports: 2



① Quick Coupler ② On-Off-Auto Selector



MP ROTATOR™



ADVANCED FEATURES

AUTOMATIC MATCHED PRECIPITATION

MP Rotator Nozzles adjust the flow rate through the nozzle as the radius and arc are changed, resulting in the same matched precipitation rate regardless of the nozzle setting.

DOUBLE-POP FEATURE

MP Rotator Nozzles pop up from their protected position only after the riser is fully extended, providing superior defence against dirt and debris.



HIGH DISTRIBUTION UNIFORMITY

The multiple streams of the MP Rotator Nozzle target all areas of the landscape evenly, resulting in superior uniformity over traditional spray nozzles and better wind resistance.

LOW PRECIPITATION RATE

Since the majority of soils have a water infiltration rate of less than 25 mm/hr, irrigating at a low precipitation rate is essential to reduce runoff and increase efficiency.

The Standard MP Rotator Nozzle applies water at 10 mm/hr, while the MP800 Nozzle model has a precipitation rate of 20 mm/hr. Either choice will avoid runoff, save water, and prevent erosion.

STANDARD MP Rotator Nozzles

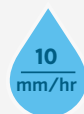

2.5 to 10.7 m

- Maximum water efficiency
- Slowest precipitation rate

MP ROTATOR MP800 Nozzles

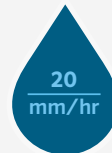

1.8 to 4.9 m

- Small spaces
- Tight water windows

MP ROTATOR Strip Nozzles



1.5 m wide

- Rectangular spaces
- Pair with either option

ECO-ROTATOR

Radius: 2.5 to 9.1 m

This compact sprinkler comes with a pre-installed MP Rotator™ Nozzle that provides up to 30% more water savings over traditional spray nozzles.

KEY BENEFITS

- Automatic matched precipitation for simplified irrigation design and flexibility
- High distribution uniformity for a healthy landscape and maximum water efficiency
- Double-pop feature protects the nozzle from external debris
- Large inlet filter screen protects the nozzle from internal debris in the system
- Heavy-duty spring for consistent riser retraction

ADDITIONAL FEATURES

- Wind-resistant, multi-stream technology prevents misting
- For vandal resistance, the arc is adjustable only when the MP Rotator Nozzle is running
- Colour-coded for easy field identification
- Two-piece ratcheting riser

OPERATING SPECIFICATIONS

- Low precipitation rate
- Radius range: 1.8 to 9.1 m
- Operational pressure range: 1.7 to 3.8 bar; 170 to 380 kPa
- Recommended operating pressure: 2.8 bar; 280 kPa
- Warranty period: 2 years

USER-INSTALLED OPTION

- Drain Check Valve (up to 2 m of elevation; P/N 462237SP)



Eco-Rotator
Retracted height: 18 cm
Pop-up height: 10 cm
Exposed diameter: 3 cm
Inlet size: ½"

ECO-ROTATOR PERFORMANCE DATA

ECO-04 MP800SR

Radius: 1.8 to 3.5 m

Adjustable Arc and Full-Circle

● Orange and Grey: 90° to 210°

● Lime Green and Grey: 360°

MAX RADIUS								MIN RADIUS		
Arc	Pressure		Radius	Flow		Precip. mm/hr		Radius	Flow	
	bar	kPa		m ³ /hr	l/min	■	▲		m	m ³ /hr
90° ■	2.1	210	2.6	0.04	0.61	22	25	1.8	0.03	0.49
	2.5	250	2.9	0.04	0.72	21	24	2.1	0.03	0.55
	2.8	280	3.1	0.05	0.87	21	24	2.4	0.04	0.61
	3.0	300	3.4	0.06	0.95	20	23	2.4	0.04	0.68
	3.5	350	3.5	0.06	1.02	20	23	2.7	0.04	0.72
	3.8	380	3.5	0.06	1.06	20	23	3.0	0.05	0.76
180° ■	2.1	210	2.6	0.07	1.21	22	25	1.8	0.06	0.98
	2.5	250	2.8	0.08	1.40	21	24	2.1	0.07	1.10
	2.8	280	3.0	0.10	1.59	21	24	2.4	0.07	1.21
	3.0	300	3.3	0.10	1.74	19	22	2.4	0.08	1.36
	3.5	350	3.4	0.11	1.82	19	22	2.7	0.09	1.44
	3.8	380	3.5	0.11	1.89	18	21	3.0	0.09	1.51
210° ■	2.1	210	2.6	0.08	1.40	22	25	1.8	0.07	1.15
	2.5	250	2.8	0.10	1.67	22	25	2.1	0.08	1.28
	2.8	280	3.0	0.11	1.85	21	24	2.4	0.08	1.41
	3.0	300	3.2	0.12	2.01	20	23	2.4	0.10	1.59
	3.5	350	3.4	0.13	2.12	19	22	2.7	0.10	1.68
	3.8	380	3.5	0.13	2.20	18	21	3.0	0.11	1.77
360° ●	2.1	210	2.6	0.14	2.38	22	25	1.8	0.11	1.78
	2.5	250	2.8	0.16	2.65	20	23	2.1	0.12	1.97
	2.8	280	3.0	0.18	2.95	20	23	2.4	0.13	2.12
	3.0	300	3.1	0.19	3.22	20	23	2.4	0.13	2.23
	3.5	350	3.3	0.20	3.33	19	21	2.7	0.14	2.38
	3.8	380	3.5	0.22	3.71	18	21	3.0	0.16	2.65

Bold = Recommended pressure

ECO-ROTATOR

Model	Description
ECO-04-800SR-90	10 cm pop-up, MP800SR 1.8 to 3.5 m radius, adjustable from 90° to 210°
ECO-04-800SR-360	10 cm pop-up, MP800SR 1.8 to 3.5 m radius, 360°
ECO-04-1090	10 cm pop-up, MP1000 2.5 to 4.5 m radius, adjustable from 90° to 210°
ECO-04-10360	10 cm pop-up, MP1000 2.5 to 4.5 m radius, 360°
ECO-04-2090	10 cm pop-up, MP2000 4.0 to 6.4 m radius, adjustable from 90° to 210°
ECO-04-20360	10 cm pop-up, MP2000 4.0 to 6.4 m radius, 360°
ECO-04-3090	10 cm pop-up, MP3000 6.7 to 9.1 m radius, adjustable from 90° to 210°
ECO-04-30360	10 cm pop-up, MP3000 6.7 to 9.1 m radius, 360°

Eco-Rotator



MP ROTATOR

ECO-ROTATOR PERFORMANCE DATA

ECO-04 MP1000

Radius: 2.5 to 4.5 m
Adjustable Arc and Full-Circle
● Maroon: 90° to 210°
● Olive: 360°

ECO-04 MP2000

Radius: 4.0 to 6.4 m
Adjustable Arc and Full-Circle
● Black: 90° to 210°
● Red: 360°

ECO-04 MP3000

Radius: 6.7 to 9.1 m
Adjustable Arc and Full-Circle
● Blue: 90° to 210°
● Grey: 360°

Arc	Pressure		Radius		Flow	Flow	Precip mm/hr		Radius		Flow	Flow	Precip mm/hr		Radius		Flow	Flow	Precip mm/hr																																																																																						
	bar	kPa	m	m	m ³ /hr	l/min	■	▲	m	m ³ /hr	l/min	■	▲	m	m ³ /hr	l/min	■	▲	m	m ³ /hr	l/min	■	▲																																																																																		
90° 👤	2.1	210	3.7	0.04	0.64	11	13	5.5	0.09	1.44	12	13	8.2	0.17	2.88	10	12	2.5	250	4.0	0.04	0.72	11	13	5.8	0.09	1.52	11	13	8.5	0.19	3.11	10	12	2.8	280	4.1	0.05	0.80	11	13	6.1	0.10	1.63	11	12	9.1	0.20	3.26	10	11	3.0	300	4.3	0.05	0.87	11	13	6.4	0.11	1.74	10	12	9.1	0.21	3.41	10	12	3.5	350	4.5	0.06	0.95	11	13	6.4	0.11	1.78	11	12	9.1	0.22	3.60	11	12	3.8	380	4.5	0.06	1.02	12	14	6.4	0.11	1.82	11	12	9.1	0.23	3.83	11	13			
	180° 👤	2.1	210	3.7	0.08	1.29	11	13	5.2	0.15	2.43	11	13	8.2	0.36	5.99	11	12	2.5	250	4.0	0.09	1.44	11	13	5.5	0.16	2.69	11	12	8.5	0.39	6.44	11	12	2.8	280	4.1	0.10	1.59	11	13	5.8	0.18	2.92	11	12	9.1	0.42	6.90	10	12	3.0	300	4.3	0.10	1.67	11	13	6.1	0.20	3.22	11	12	9.1	0.44	7.31	11	12	3.5	350	4.5	0.12	1.90	11	13	6.4	0.21	3.45	10	12	9.1	0.47	7.73	11	13	3.8	380	4.5	0.12	1.93	12	13	6.4	0.22	3.60	11	12	9.1	0.49	8.07	12	14		
		210° 👤	2.1	210	3.7	0.09	1.52	12	13	5.2	0.17	2.84	11	13	8.2	0.42	6.97	11	12	2.5	250	4.0	0.10	1.71	11	13	5.5	0.19	3.07	11	12	8.5	0.46	7.54	11	13	2.8	280	4.1	0.11	1.86	11	13	5.8	0.20	3.26	10	12	9.1	0.49	8.03	10	12	3.0	300	4.3	0.12	1.93	11	13	6.1	0.21	3.45	10	11	9.1	0.52	8.53	11	12	3.5	350	4.5	0.13	2.16	11	13	6.4	0.23	3.71	9	11	9.1	0.55	8.98	11	13	3.8	380	4.5	0.14	2.24	11	13	6.4	0.23	3.83	10	11	9.1	0.57	9.44	12	14	
			360° ●	2.1	210	3.7	0.16	2.62	12	13	5.2	0.29	4.85	11	13	8.2	0.72	11.94	11	12	2.5	250	4.0	0.18	2.92	11	13	5.5	0.32	5.19	10	12	8.5	0.78	12.89	11	12	2.8	280	4.1	0.19	3.18	11	13	5.8	0.34	5.61	10	12	9.1	0.84	13.80	10	12	3.0	300	4.3	0.20	3.34	11	13	6.1	0.36	5.95	10	11	9.1	0.89	14.63	11	12	3.5	350	4.5	0.23	3.71	11	13	6.4	0.39	6.37	9	11	9.1	0.94	15.43	11	13	3.8	380	4.5	0.23	3.83	11	13	6.4	0.40	6.59	10	11	9.1	0.98	16.18	12	14

Bold = Recommended pressure

STANDARD MP ROTATOR™

The MP Rotator Nozzle is the most trusted high-efficiency solution on the market, offering up to 30% water savings over traditional spray nozzles.

Radius: 2.5 to 10.7 m

10
mm/hr

KEY BENEFITS

- Lowest precipitation rate in the industry of approximately 10 mm/hr
- Matched precipitation for simplified irrigation design and flexibility
- Double-pop feature protects the nozzle from external debris
- High distribution uniformity for a healthy landscape with maximum water efficiency

ADDITIONAL FEATURES

- Wind-resistant, multi-stream technology prevents misting
- For vandal resistance, the arc is adjustable only when the MP Rotator Nozzle is running
- Removable filter screen prevents nozzle from clogging
- Colour-coded for easy identification

OPERATING SPECIFICATIONS

- Radius reduction up to approximately 25% on all models
- Recommended operating pressure: 2.8 bar; 280 kPa
- Minimum radius setting achieved at 2.1 bar; 210 kPa
- Warranty period: 3 years

OPTIONS

- Pair with Pro-Spray™ PRS40 Sprinkler Body for pressure regulation to 2.8 bar; 280 kPa for nominal radius settings
- Pair with Pro-Spray PRS30 Sprinkler Body for pressure regulation to 2.1 bar; 210 kPa for minimum radius settings

MP ROTATOR – SPECIFICATION BUILDER: ORDER 1 + 2

1 Model	2 Options
MP1000-90 = 2.5 to 4.5 m radius, adjustable from 90° to 210°	(blank) = No option HT = Male threaded version (Not available in 3500 and 1000-210)
MP1000-210 = 2.5 to 4.5 m radius, adjustable from 210° to 270°	
MP1000-360 = 2.5 to 4.5 m radius, 360°	
MP2000-90 = 4.0 to 6.4 m radius, adjustable from 90° to 210°	
MP2000-210 = 4.0 to 6.4 m radius, adjustable from 210° to 270°	
MP2000-360 = 4.0 to 6.4 m radius, 360°	
MP3000-90 = 6.7 to 9.1 m radius, adjustable from 90° to 210°	
MP3000-210 = 6.7 to 9.1 m radius, adjustable from 210° to 270°	
MP3000-360 = 6.7 to 9.1 m radius, 360°	
MP3500-90 = 9.4 to 10.7 m radius, adjustable from 90° to 210°	
MPLCS-515 = Left corner strip, 1.5 m x 4.6 m	
MPRCS-515 = Right corner strip, 1.5 m x 4.6 m	
MPSS-530 = Side strip, 1.5 m x 9.1 m	
MP-CORNER = 2.5 to 4.5 m radius, adjustable from 45° to 105°	

MP1000: 2.5 to 4.5 m radius



MP1000-90
90° to 210°



MP1000-210
210° to 270°



MP1000-360
360°

MP2000: 4.0 to 6.4 m radius



MP2000-90
90° to 210°



MP2000-210
210° to 270°



MP2000-360
360°

MP3000: 6.7 to 9.1 m radius



MP3000-90
90° to 210°



MP3000-210
210° to 270°



MP3000-360
360°

MP3500: 9.4 to 10.7 m radius



MP3500-90
90° to 210°

MP ROTATOR PERFORMANCE DATA

MP1000





Radius: 2.5 to 4.5 m
Adjustable Arc and Full-Circle
● Maroon: 90° to 210°
● Lt. Blue: 210° to 270°
● Olive: 360°

MP2000

Radius: 4.0 to 6.4 m
Adjustable Arc and Full-Circle
● Black: 90° to 210°
● Green: 210° to 270°
● Red: 360°

MP3000

Radius: 6.7 to 9.1 m
Adjustable Arc and Full-Circle
● Blue: 90° to 210°
● Yellow: 210° to 270°
● Grey: 360°

Arc	Pressure		Radius	Flow m ³ /hr	Flow l/min	Precip mm/hr		Radius	Flow m ³ /hr	Flow l/min	Precip mm/hr		Radius	Flow m ³ /hr	Flow l/min	Precip mm/hr	
	bar	kPa				■	▲				■	▲				■	▲
90° 	2.1	210	3.7	0.04	0.64	11	13	5.5	0.09	1.44	12	13	8.2	0.17	2.88	10	12
	2.5	250	4.0	0.04	0.72	11	13	5.8	0.09	1.52	11	13	8.5	0.19	3.11	10	12
	2.8	280	4.1	0.05	0.80	11	13	6.1	0.10	1.63	11	12	9.1	0.20	3.26	10	11
	3.0	300	4.3	0.05	0.87	11	13	6.4	0.11	1.74	10	12	9.1	0.21	3.41	10	12
	3.5	350	4.5	0.06	0.95	11	13	6.4	0.11	1.78	11	12	9.1	0.22	3.60	11	12
	3.8	380	4.5	0.06	1.02	12	14	6.4	0.11	1.82	11	12	9.1	0.23	3.83	11	13
180° 	2.1	210	3.7	0.08	1.29	11	13	5.2	0.15	2.43	11	13	8.2	0.36	5.99	11	12
	2.5	250	4.0	0.09	1.44	11	13	5.5	0.16	2.69	11	12	8.5	0.39	6.44	11	12
	2.8	280	4.1	0.10	1.59	11	13	5.8	0.18	2.92	11	12	9.1	0.42	6.90	10	12
	3.0	300	4.3	0.10	1.67	11	13	6.1	0.20	3.22	11	12	9.1	0.44	7.31	11	12
	3.5	350	4.5	0.12	1.90	11	13	6.4	0.21	3.45	10	12	9.1	0.47	7.73	11	13
	3.8	380	4.5	0.12	1.93	12	13	6.4	0.22	3.60	11	12	9.1	0.49	8.07	12	14
210° 	2.1	210	3.7	0.09	1.52	12	13	5.2	0.17	2.84	11	13	8.2	0.42	6.97	11	12
	2.5	250	4.0	0.10	1.71	11	13	5.5	0.19	3.07	11	12	8.5	0.46	7.54	11	13
	2.8	280	4.1	0.11	1.86	11	13	5.8	0.20	3.26	10	12	9.1	0.49	8.03	10	12
	3.0	300	4.3	0.12	1.93	11	13	6.1	0.21	3.45	10	11	9.1	0.52	8.53	11	12
	3.5	350	4.5	0.13	2.16	11	13	6.4	0.23	3.71	9	11	9.1	0.55	8.98	11	13
	3.8	380	4.5	0.14	2.24	11	13	6.4	0.23	3.83	10	11	9.1	0.57	9.44	12	14
270° 	2.1	210	3.7	0.11	1.82	11	12	5.2	0.22	3.60	11	12	8.2	0.55	8.98	11	12
	2.5	250	4.0	0.12	2.01	10	12	5.5	0.24	3.90	10	12	8.5	0.59	9.66	11	12
	2.8	280	4.1	0.14	2.39	11	13	5.8	0.25	4.17	10	12	9.1	0.63	10.35	10	12
	3.0	300	4.3	0.15	2.54	11	13	6.1	0.27	4.43	10	11	9.1	0.66	10.95	11	12
	3.5	350	4.5	0.17	2.73	11	13	6.4	0.28	4.66	9	11	9.1	0.70	11.60	11	13
	3.8	380	4.5	0.17	2.84	11	13	6.4	0.30	4.93	10	11	9.1	0.74	12.20	12	14
360° 	2.1	210	3.7	0.16	2.62	12	13	5.2	0.29	4.85	11	13	8.2	0.72	11.94	11	12
	2.5	250	4.0	0.18	2.92	11	13	5.5	0.32	5.19	10	12	8.5	0.78	12.89	11	12
	2.8	280	4.1	0.19	3.18	11	13	5.8	0.34	5.61	10	12	9.1	0.84	13.80	10	12
	3.0	300	4.3	0.20	3.34	11	13	6.1	0.36	5.95	10	11	9.1	0.89	14.63	11	12
	3.5	350	4.5	0.23	3.71	11	13	6.4	0.39	6.37	9	11	9.1	0.94	15.43	11	13
	3.8	380	4.5	0.23	3.83	11	13	6.4	0.40	6.59	10	11	9.1	0.98	16.18	12	14

Bold = Optimal pressure for the MP Rotator Nozzle is 2.8 bar; 280 kPa. This can easily be achieved by using it with the pressure-regulated Pro-Spray PRS40 Sprinkler Body at 2.8 bar; 280 kPa.

Works best with Pro-Spray PRS40



Smart WaterMark
Recognised as a responsible water-saving tool



Compatible with:



Pro-Spray PRS40
Page 72

MP ROTATOR PERFORMANCE DATA

MP3500
 Radius: 9.4 to 10.7 m
 Adjustable Arc
 ● Light Brown: 90° to 210°

Arc	Pressure		Radius m	Flow m ³ /hr	Flow l/min	Precip. mm/hr	
	bar	kPa				■	▲
90° 	2.1	210	10.4	0.26	4.28	10	11
	2.5	250	10.4	0.28	4.58	10	12
	2.8	280	10.7	0.29	4.84	10	12
	3.0	300	10.7	0.31	5.22	11	13
	3.5	350	10.7	0.33	5.41	11	13
	3.8	380	10.7	0.34	5.68	12	14
180° 	2.1	210	10.4	0.51	8.48	9	11
	2.5	250	10.4	0.60	10.03	11	13
	2.8	280	10.7	0.65	10.83	11	13
	3.0	300	10.7	0.70	11.73	12	14
	3.5	350	10.7	0.73	12.15	13	15
	3.8	380	10.7	0.75	12.41	13	15
210° 	2.1	210	10.4	0.65	10.75	10	12
	2.5	250	10.4	0.70	11.66	11	13
	2.8	280	10.7	0.75	12.45	11	13
	3.0	300	10.7	0.80	13.40	12	14
	3.5	350	10.7	0.85	14.23	13	15
	3.8	380	10.7	0.90	14.91	13	16



Bold = Optimal pressure for the MP Rotator Nozzle is 2.8 bar; 280 kPa. This can easily be achieved by using it with the pressure-regulated Pro-Spray PRS40 Sprinkler Body at 2.8 bar; 280 kPa.

MP3500



MP ROTATOR PERFORMANCE DATA

● **MPLCS-515**: Ivory, MP Left Corner Strip
 ● **MPRCS-515**: Copper, MP Right Corner Strip
 ● **MPSS-530**: Brown, MP Side Strip

	Pressure		Radius m	Flow m ³ /hr	Flow l/min	Precip. mm/hr	
	bar	kPa				■	▲
MP Left Corner Strip 	2.1	210	1.2 x 4.2	0.04	0.64	31	15
	2.5	250	1.4 x 4.4	0.04	0.68	27	13
	2.8	280	1.5 x 4.5	0.04	0.72	26	13
	3.0	300	1.6 x 4.6	0.05	0.79	26	13
	3.5	350	1.7 x 4.7	0.05	0.87	26	13
	3.8	380	1.8 x 4.8	0.05	0.91	25	13
MP Right Corner Strip 	2.1	210	1.2 x 4.2	0.04	0.64	31	15
	2.5	250	1.4 x 4.4	0.04	0.68	27	13
	2.8	280	1.5 x 4.5	0.04	0.72	26	13
	3.0	300	1.6 x 4.6	0.05	0.79	26	13
	3.5	350	1.7 x 4.7	0.05	0.87	26	13
	3.8	380	1.8 x 4.8	0.05	0.91	25	13
MP Side Strip 	2.1	210	1.2 x 8.4	0.07	1.25	30	15
	2.5	250	1.4 x 8.7	0.08	1.36	27	13
	2.8	280	1.5 x 9.0	0.09	1.44	26	13
	3.0	300	1.6 x 9.3	0.09	1.55	25	13
	3.5	350	1.7 x 9.6	0.10	1.67	24	12
	3.8	380	1.8 x 9.9	0.11	1.79	24	12

MP Rotator Strip Nozzles



MPLCS-515
Left Corner Strip
1.5 x 4.6 m

MPRCS-515
Right Corner Strip
1.5 x 4.6 m

MPSS-530
Side Strip
1.5 x 9.1 m



Notes:
 To match the precipitation rate of MP Rotator MP800 Nozzles, use rectangular spacing.

See **page 204** for precipitation rate calculation.

MP ROTATOR PERFORMANCE DATA

MP Corner
 Radius: 2.5 to 4.5 m
 Adjustable Arc
 ● Turquoise: 45° to 105°

Arc	Pressure		Radius m	Flow m ³ /hr	Flow l/min
	bar	kPa			
45° ▶	2.1	210	3.5	0.04	0.61
	2.5	250	4.0	0.04	0.68
	2.8	280	4.1	0.04	0.70
	3.0	300	4.3	0.04	0.73
	3.5	350	4.4	0.05	0.78
90° ◐	2.1	210	3.5	0.08	1.27
	2.5	250	4.0	0.08	1.40
	2.8	280	4.1	0.09	1.44
	3.0	300	4.3	0.09	1.57
	3.5	350	4.4	0.10	1.67
105° ◑	2.1	210	3.5	0.09	1.48
	2.5	250	4.0	0.10	1.63
	2.8	280	4.1	0.10	1.70
	3.0	300	4.3	0.11	1.83
	3.5	350	4.4	0.12	1.94
3.8	380	4.5	0.12	2.00	

MP Corner



MP-CORNER
 Corner
 2.5 to 4.5 m

Male Threaded



MP-HT
 Male Threaded

MP Accessories



MPTOOL
 Adjusts all MP Rotator
 Nozzles



MPSTICK
 Snaps onto any length of
 1" (25 mm) PVC to allow for
 standing adjustment.
 PVC pipe not included.

MP Corner

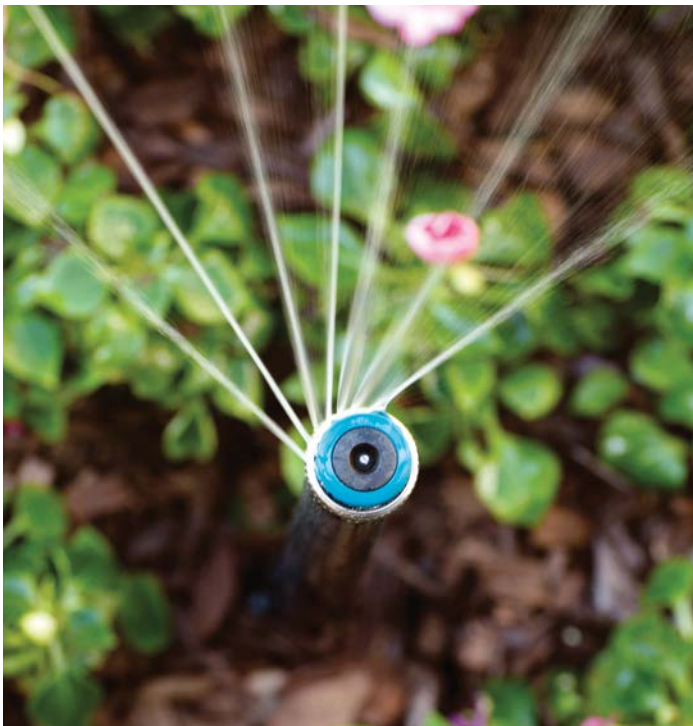

MP Tool for easy adjustments



MP ROTATOR™ MP800

The MP800 offers a higher precipitation rate perfect for small spaces and spray retrofits.

Radius: 1.8 to 4.9 m

20
mm/hr

KEY BENEFITS

- Precipitation rate of approximately 20 mm/hr for spray retrofit applications
- Automatic matched precipitation for simplified irrigation design and flexibility
- Double-pop feature protects the nozzle from external debris
- High distribution uniformity for a healthy landscape with maximum water efficiency

ADDITIONAL FEATURES

- Wind-resistant, multi-stream technology prevents misting
- For vandal resistance, the arc is adjustable only when the MP Rotator Nozzle is running
- Removable filter screen prevents nozzle clogging
- Colour-coded for easy identification

OPERATING SPECIFICATIONS

- Radius reduction up to approximately 25% on all models
- Recommended operating pressure: 2.8 bar; 280 kPa
- Minimum radius setting achieved at 2.1 bar; 210 kPa
- Filtration recommended on dirty water applications
- Warranty period: 3 years

OPTIONS

- Pair with Pro-Spray™ PRS40 Sprinkler Body for pressure regulation to 2.8 bar; 280 kPa for nominal radius settings
- Pair with Pro-Spray PRS30 Sprinkler Body for pressure regulation to 2.1 bar; 210 kPa for minimum radius settings

MP800SR: 1.8 m to 3.5 m radius



MP800SR-90
90° to 210°



MP800SR-360
360°

MP815: 2.5 m to 4.9 m radius



MP815-90
90° to 210°



MP815-210
210° to 270°



MP815-360
360°

Compatible with:



HY Filter
Page 168



PRS30 and PRS40
Page 70 and
Page 72

MP800SR-90







MP815-90



MP ROTATOR PERFORMANCE DATA

MP800SR

Radius: 1.8 to 3.5 m
Adjustable Arc and Full-Circle
● Orange and Grey: 90° to 210°
● Lime Green and Grey: 360°





MAX RADIUS							MIN RADIUS			
Arc	Pressure		Radius	Flow		Precip. mm/hr		Radius		
	bar	kPa	m	m ³ /hr	l/min	■	▲	m	m ³ /hr	l/min
90° 	2.1	210	2.6	0.04	0.61	22	25	1.8	0.03	0.49
	2.5	250	2.9	0.04	0.72	21	24	2.1	0.03	0.55
	2.8	280	3.1	0.05	0.87	21	24	2.4	0.04	0.61
	3.0	300	3.4	0.06	0.95	20	23	2.4	0.04	0.68
	3.5	350	3.5	0.06	1.02	20	23	2.7	0.04	0.72
	3.8	380	3.5	0.06	1.06	20	23	3.0	0.05	0.76
180° 	2.1	210	2.6	0.07	1.21	22	25	1.8	0.06	0.98
	2.5	250	2.8	0.08	1.40	21	24	2.1	0.07	1.10
	2.8	280	3.0	0.10	1.59	21	24	2.4	0.07	1.21
	3.0	300	3.3	0.10	1.74	19	22	2.4	0.08	1.36
	3.5	350	3.4	0.11	1.82	19	22	2.7	0.09	1.44
	3.8	380	3.5	0.11	1.89	18	21	3.0	0.09	1.51
210° 	2.1	210	2.6	0.08	1.40	22	25	1.8	0.07	1.15
	2.5	250	2.8	0.10	1.67	22	25	2.1	0.08	1.28
	2.8	280	3.0	0.11	1.85	21	24	2.4	0.08	1.41
	3.0	300	3.2	0.12	2.01	20	23	2.4	0.10	1.59
	3.5	350	3.4	0.13	2.12	19	22	2.7	0.10	1.68
	3.8	380	3.5	0.13	2.20	18	21	3.0	0.11	1.77
360° 	2.1	210	2.6	0.14	2.38	22	25	1.8	0.11	1.78
	2.5	250	2.8	0.16	2.65	20	23	2.1	0.12	1.97
	2.8	280	3.0	0.18	2.95	20	23	2.4	0.13	2.12
	3.0	300	3.1	0.19	3.22	20	23	2.4	0.13	2.23
	3.5	350	3.3	0.20	3.33	19	21	2.7	0.14	2.38
	3.8	380	3.5	0.22	3.71	18	21	3.0	0.16	2.65

Bold = Optimal pressure for the MP Rotator Nozzle is 2.8 bar; 280 kPa. This can easily be achieved by using it with the pressure-regulated Pro-Spray PRS40 Sprinkler Body at 2.8 bar; 280 kPa.

MP ROTATOR PERFORMANCE DATA

MP815

Radius: 2.5 to 4.9 m
Adjustable Arc and Full-Circle
● Maroon and Grey: 90° to 210°
● Lt. Blue and Grey: 210° to 270°
● Olive and Grey: 360°

Arc	Pressure		Radius	Flow		Precip. mm/hr	
	bar	kPa	m	m ³ /hr	l/min	■	▲
90° 	2.1	210	4.3	0.10	1.59	21	24
	2.5	250	4.5	0.10	1.74	21	24
	2.8	280	4.6	0.11	1.85	21	24
	3.1	310	4.8	0.12	1.97	21	24
	3.5	350	4.9	0.12	2.08	21	24
	3.8	380	4.9	0.13	2.20	22	25
180° 	2.1	210	4.0	0.17	2.84	21	25
	2.5	250	4.3	0.20	3.26	21	24
	2.8	280	4.5	0.21	3.52	21	24
	3.1	310	4.6	0.22	3.63	21	24
	3.5	350	4.8	0.24	4.01	21	24
	3.8	380	4.9	0.25	4.20	21	24
210° 	2.1	210	4.0	0.20	3.33	21	25
	2.5	250	4.3	0.22	3.63	20	23
	2.8	280	4.5	0.25	4.16	21	24
	3.1	310	4.6	0.26	4.39	21	25
	3.5	350	4.8	0.28	4.69	21	24
	3.8	380	4.9	0.30	4.92	21	24
270° 	2.1	210	4.0	0.26	4.31	22	25
	2.5	250	4.3	0.28	4.69	20	23
	2.8	280	4.5	0.32	5.30	21	24
	3.1	310	4.6	0.33	5.56	21	24
	3.5	350	4.8	0.35	5.83	20	23
	3.8	380	4.9	0.37	6.09	20	23
360° 	2.1	210	4.0	0.35	5.75	22	25
	2.5	250	4.3	0.39	6.43	21	24
	2.8	280	4.5	0.42	7.08	21	24
	3.1	310	4.6	0.45	7.57	21	25
	3.5	350	4.8	0.48	8.06	21	24
	3.8	380	4.9	0.51	8.55	21	25

MP ROTATOR STAKE KIT

Models: **Standard and Pressure-Regulated Staking Kits**

Designed for easy implementation with any water-efficient MP Rotator Nozzle, MP Stake Kits come preassembled for quick installation in the field.

KEY BENEFITS

- Pair with any high-efficiency MP Rotator Nozzle to simplify temporary irrigation
- Preassembled for fast and easy installation in the field
- Standard kit includes a 66 cm stake, nozzle adapter, 0.345" (9 mm) tubing, and ½" threaded male fitting for quick connection
- For maximum water savings, upgrade to a 2.8 bar (280 kPa) pressure regulator and Hunter Check Valve

OPERATING SPECIFICATIONS

- Operational pressure range: 2.1 to 4.8 bar (210 to 480 kPa)

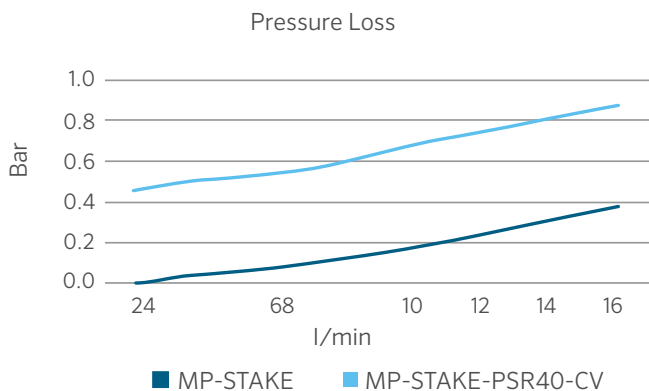

MP-STAKE

Total height: 71 cm
Male threaded connection: ½"

MP-STAKE-PSR40-CV

Total height: 86 cm
Male threaded connection: ½"

Compatible with:



All MP Rotator Nozzles
Page 54 and 58



Spray Nozzles
Page 75

MP-STAKE-PSR40-CV Installation



MP-STAKE MODELS	
Model	Description
MP-STAKE	66 cm stake, 0.345" (9 mm) tubing to ½" male fitting, PROS-00 shrub adapter (total height: 71 cm)
MP-STAKE-PSR40-CV	66 cm stake, 0.345" (9 mm) tubing to ½" male fitting, Hunter Check Valve, PROS-00-PSR40 pressure-regulated shrub adapter (total height: 86 cm)



ENGINEERED FOR *MAXIMUM EFFICIENCY*

DURABLE

With only one moving part, the MP Rotator is built with the highest-quality materials to ensure long-lasting performance in every installation.

FLEXIBLE

Matched precipitation across 1.5 m wide strips to 10.7 m radius allows the MP Rotator to fit a wide range of landscapes with uniform coverage for healthy plants.

EFFICIENT

The rotating streams of water cut through wind, reduce misting, and distribute water at a slow, even rate that soils can better absorb, preventing runoff.

RELIABLE

With more than 15 years of proven performance with Hunter Industries, the MP Rotator is the most trusted high-efficiency nozzle on the market.

A vibrant garden scene captured during a watering session. A sprinkler system is in operation, with numerous fine jets of water spraying across the frame. The background is filled with lush green foliage, including tall, slender plants with yellow-green leaves. In the mid-ground, there are clusters of bright orange flowers, possibly marigolds, and some purple flowers. The foreground shows a dense layer of low-growing, bright green ground cover. The overall atmosphere is fresh and lively, with the water droplets catching the light and creating a soft, misty effect.

SPRAY SPRINKLER BODIES



SPRAY SPRINKLER BODY

ADVANCED FEATURES

STRENGTH & DURABILITY



CO-MOULDED WIPER SEAL

Moulded with two types of chemical- and chlorine-resistant materials, this multi-function wiper seal reduces flow-by, allowing more heads on one zone, and prevents debris from entering the seal, reducing riser stick-ups.

FLOGUARD™ TECHNOLOGY



In the event of a missing nozzle, FloGuard Technology reduces the flow of water from the riser to a 1.9 l/min (3 m tall) indicator stream, eliminating water waste and preventing landscape erosion while providing a visual indicator for repair.



HEAVY-DUTY SPRING

The industry's strongest spring offers positive retraction under any conditions.



CHECK VALVE

Optional field- or factory-installed check valves eliminate leaks and puddles at the lower heads, protecting landscapes from damage and erosion while reducing water waste.



PRESSURE-REGULATED TO 2.1 & 2.8 BAR

Pressure-regulated Pro-Spray™ Sprinkler Bodies optimise the performance of the nozzle, reducing flow rates and preventing misting. The brown PRS30 model regulates pressures to 2.1 bar; 210 kPa for spray nozzles. The grey PRS40 model regulates pressures to 2.8 bar; 280 kPa when paired with the efficient MP Rotator Nozzle.

INDUSTRY'S STRONGEST SPRAY BODY



The Pro-Spray line incorporates a heavy-duty ribbed body and durable cap engineered to withstand the harshest environments, including the rigors of foot traffic and the abuses of heavy machinery. In addition, the buttress thread design provides superior strength in cap-to-body gripping capacity, helping the head to withstand high inlet surge pressures.

PRO-SPRAY



COMPETITOR







INNOVATIVE SEAL DESIGN

Pedestrian traffic, landscape equipment, temperature changes, and cycling pressures can cause body caps to loosen. Pro-Spray caps can withstand more than one full 360° turn and remain sealed at any pressure, preventing excess runoff.

Pro-Spray: Seal remains intact

Competitor: Significant leaking at the body cap

SPRAY SPRINKLER BODY COMPARISON CHART

QUICK SPECS		 PS ULTRA	 PRO-SPRAY®	 PRO-SPRAY PRS30	 PRO-SPRAY PRS40
		Good	Better	Best for Spray Nozzles	Best for MP Rotator™ Nozzles
POP-UP HEIGHT	cm	5, 10, 15	Shrub, 5, 7.5, 10, 15, 30	Shrub, 7.5, 10, 15, 30	Shrub, 7.5, 10, 15, 30
PRESSURE-REGULATED	bar	N/A	N/A	2.1	2.8
	kPa	N/A	N/A	210	280
FEATURES					
PREINSTALLED NOZZLE		5SS, 8A, 10A, 12A, 15A, 17A	N/A	N/A	N/A
CAP COLOUR		Black	Black	Brown	Grey
CHECK VALVES		Field-Installed	Field-Installed or Factory-Installed	Field-Installed or Factory-Installed	Field-Installed or Factory-Installed
WARRANTY		2 Years	5 Years	5 Years	5 Years
ADVANCED FEATURES					
BODY STYLE		Slim Line	Rugged Body	Rugged Body	Rugged Body
SPRING		Standard	Heavy-Duty	Heavy-Duty	Heavy-Duty
CO-MOULDED WIPER SEAL			●	●	●
RECLAIMED CAP			●	●	●
PRESSURE REGULATION				●	●
FLOGUARD™ TECHNOLOGY				●	●
APPLICATIONS					
TURFGRASS		●	●	●	●
TURFGRASS: TALL MOWING HEIGHT		●	●	●	●
SHRUBS: SPRINKLERS ON RISERS			●	●	●
SHRUBS: TALL POP-UP SPRINKLERS			●	●	●
RESIDENTIAL		●	●	●	●
COMMERCIAL/MUNICIPALITIES			●	●	●
HIGH-TRAFFIC AREAS			●	●	●
RECLAIMED WATER			●	●	●

PS ULTRA

The PS Ultra is a compact, slim-line spray sprinkler with the option of preinstalled nozzles for faster installation.

KEY BENEFITS

- Enhanced cap for more durability, easier handling, and extended riser seal life
- Large inlet filter screen for increased debris resistance
- Check valve option eliminates low-head drainage
- Heavy-duty spring for consistent riser retraction

ADDITIONAL FEATURES

- Directional flush plug design for cleaner installation
- Two-piece ratcheting riser
- 5 cm and 10 cm models can retrofit into older style PS models
- Compatible with all female-threaded nozzles

OPERATING SPECIFICATIONS

- Operational pressure range: 1.4 to 4.8 bar; 140 to 480 kPa
- Warranty period: 2 years

FACTORY-INSTALLED OPTIONS

- Flush plug (large filter screen not included)
- Nozzles 2.4 m, 3.0 m, 3.7 m, 4.6 m, 5.2 m, 1.5 x 9.0 m side strip
- Large inlet filter screen included in 10 cm and 15 cm preinstalled nozzle models

USER-INSTALLED OPTIONS

- Check valve installs in filter screen for 10 cm and 15 cm models (up to 2 m of elevation; P/N 462237SP)
- Large inlet filter screen (P/N 162900SP)
- Shutoff nozzle (P/N 916400SP)



PSU-02

Retracted height: 12 cm
Pop-up height: 5 cm
Exposed diameter: 3 cm
Inlet size: ½"



PSU-04

Retracted height: 18 cm
Pop-up height: 10 cm
Exposed diameter: 3 cm
Inlet size: ½"



PSU-06

Retracted height: 24 cm
Pop-up height: 15 cm
Exposed diameter: 3 cm
Inlet size: ½"

PS ULTRA - SPECIFICATION BUILDER: ORDER 1 + 2 + 3 (OPTIONAL)

1 Model	2 Nozzles	3 Optional
PSU-02 = 5 cm pop-up	(blank) = Flush plug, no large filter screen	NFO = Nozzle filter only (available for 10 cm model only). Substitute standard installation of large inlet filter screen and receive unit with the nozzle filter only.
PSU-04 = 10 cm pop-up	8A = 2.4 m adjustable nozzle	
PSU-06 = 15 cm pop-up	10A = 3.0 m adjustable nozzle	
	12A = 3.7 m adjustable nozzle	
	15A = 4.6 m adjustable nozzle	
	17A = 5.2 m adjustable nozzle	
	5SS = 1.5 m x 9.1 m side strip (not available for PSU-06)	

Examples:

- PSU-04 - 15A = 10 cm pop-up, with a 4.6 m adjustable nozzle
- PSU-02 - 5SS = 5 cm pop-up, with a 1.5 m x 9.0 m side strip
- PSU-06 - 10A = 15 cm pop-up, with a 3.0 m adjustable nozzle
- PSU-04 - 12A - NFO = 10 cm pop-up, with a 3.7 m adjustable nozzle, nozzle filter only

PS ULTRA STANDARD NOZZLES PERFORMANCE DATA

8A 2.4 m radius
Adjustable from 0° to 360°
● Brown Trajectory: 15°

10A 3.0 m radius
Adjustable from 0° to 360°
● Red Trajectory: 15°

12A 3.7 m radius
Adjustable from 0° to 360°
● Green Trajectory: 28°







Arc	Pressure		Radius		Flow		Precip mm/hr		Radius		Flow		Precip mm/hr		Radius		Flow		Precip mm/hr																																																																					
	bar	kPa	m	m ³ /hr	l/min	■	▲	m	m ³ /hr	l/min	■	▲	m	m ³ /hr	l/min	■	▲	m	m ³ /hr	l/min	■	▲																																																																		
45° ▶	1.0	100	2.0	0.04	0.62	77	89	2.6	0.04	0.68	49	56	3.2	0.04	0.73	34	40	1.5	150	2.2	0.04	0.72	72	83	2.8	0.05	0.80	49	57	3.4	0.06	0.97	40	46	2.1	210	2.4	0.05	0.83	67	77	3.0	0.06	0.94	49	56	3.7	0.07	1.23	44	51	2.5	250	2.6	0.05	0.91	63	73	3.2	0.06	1.06	48	56	3.9	0.09	1.44	46	54	3.0	300	2.9	0.06	1.01	59	68	3.5	0.07	1.18	47	54	4.1	0.10	1.68	48	56			
	90° ◑	1.0	100	2.0	0.07	1.24	77	89	2.6	0.08	1.35	49	56	3.2	0.09	1.46	34	40	1.5	150	2.2	0.09	1.44	72	83	2.8	0.10	1.61	49	57	3.4	0.12	1.93	40	46	2.1	210	2.4	0.10	1.65	67	77	3.0	0.11	1.89	49	56	3.7	0.15	2.46	44	51	2.5	250	2.6	0.11	1.82	63	73	3.2	0.13	2.11	48	56	3.9	0.17	2.88	46	54	3.0	300	2.9	0.12	2.02	59	68	3.5	0.14	2.37	47	54	4.1	0.20	3.36	48	56		
		120° ◐	1.0	100	2.0	0.10	1.66	77	89	2.6	0.11	1.80	49	56	3.2	0.12	1.94	34	40	1.5	150	2.2	0.11	1.92	72	83	2.8	0.13	2.14	49	57	3.4	0.15	2.58	40	46	2.1	210	2.4	0.13	2.20	67	77	3.0	0.15	2.52	49	56	3.7	0.20	3.28	44	51	2.5	250	2.6	0.15	2.43	63	73	3.2	0.17	2.82	48	56	3.9	0.23	3.84	46	54	3.0	300	2.9	0.16	2.69	59	68	3.5	0.19	3.16	47	54	4.1	0.27	4.48	48	56	
			180° ◐	1.0	100	2.0	0.15	2.49	77	89	2.6	0.16	2.71	49	56	3.2	0.17	2.91	34	40	1.5	150	2.2	0.17	2.87	72	83	2.8	0.19	3.21	49	57	3.4	0.23	3.86	40	46	2.1	210	2.4	0.20	3.30	67	77	3.0	0.23	3.78	49	56	3.7	0.30	4.92	44	51	2.5	250	2.6	0.22	3.65	63	73	3.2	0.25	4.23	48	56	3.9	0.35	5.76	46	54	3.0	300	2.9	0.24	4.03	59	68	3.5	0.28	4.73	47	54	4.1	0.40	6.71	48	56
				240° ◑	1.0	100	2.0	0.20	3.32	77	89	2.6	0.22	3.61	49	56	3.2	0.23	3.88	34	40	1.5	150	2.2	0.23	3.83	72	83	2.8	0.26	4.28	49	57	3.4	0.31	5.15	40	46	2.1	210	2.4	0.26	4.40	67	77	3.0	0.30	5.03	49	56	3.7	0.39	6.56	44	51	2.5	250	2.6	0.29	4.86	63	73	3.2	0.34	5.64	48	56	3.9	0.46	7.68	46	54	3.0	300	2.9	0.32	5.38	59	68	3.5	0.38	6.31	47	54	4.1	0.54	8.95	48
270° ◑					1.0	100	2.0	0.22	3.73	77	89	2.6	0.24	4.06	49	56	3.2	0.26	4.37	34	40	1.5	150	2.2	0.26	4.31	72	83	2.8	0.29	4.82	49	57	3.4	0.35	5.80	40	46	2.1	210	2.4	0.30	4.95	67	77	3.0	0.34	5.66	49	56	3.7	0.44	7.38	44	51	2.5	250	2.6	0.33	5.47	63	73	3.2	0.38	6.34	48	56	3.9	0.52	8.65	46	54	3.0	300	2.9	0.36	6.05	59	68	3.5	0.43	7.10	47	54	4.1	0.60	10.07	48
	360° ●				1.0	100	2.0	0.30	4.97	77	89	2.6	0.32	5.41	49	56	3.2	0.35	5.83	34	40	1.5	150	2.2	0.34	5.75	72	83	2.8	0.39	6.43	49	57	3.4	0.46	7.73	40	46	2.1	210	2.4	0.40	6.61	67	77	3.0	0.45	7.55	49	56	3.7	0.59	9.84	44	51	2.5	250	2.6	0.44	7.29	63	73	3.2	0.51	8.45	48	56	3.9	0.69	11.53	46	54	3.0	300	2.9	0.48	8.07	59	68	3.5	0.57	9.47	47	54	4.1	0.81	13.43	48

Bold = Recommended pressure

PS ULTRA STANDARD NOZZLES PERFORMANCE DATA

15A 4.6 m radius
Adjustable from 0° to 360°
● Black Trajectory: 28°

17A 5.2 m radius
Adjustable from 0° to 360°
● Grey Trajectory: 28°

Arc	Pressure		Radius		Flow		Precip mm/hr		Radius		Flow		Precip mm/hr	
	bar	kPa	m	m ³ /hr	l/min	■	▲	m	m ³ /hr	l/min	■	▲		
45° 	1.0	100	4.0	0.08	1.27	38	43	4.6	0.10	1.68	38	43		
	1.5	150	4.3	0.09	1.51	39	45	4.9	0.12	1.94	38	44		
	2.1	210	4.6	0.11	1.79	40	46	5.2	0.13	2.23	39	45		
	2.5	250	4.9	0.12	2.00	40	46	5.5	0.15	2.46	39	45		
	3.0	300	5.2	0.14	2.25	40	46	5.8	0.16	2.72	39	45		
90° 	1.0	100	4.0	0.15	2.53	38	43	4.6	0.20	3.36	38	43		
	1.5	150	4.3	0.18	3.03	39	45	4.9	0.23	3.88	38	44		
	2.1	210	4.6	0.21	3.57	40	46	5.2	0.27	4.45	39	45		
	2.5	250	4.9	0.24	4.01	40	46	5.5	0.30	4.92	39	45		
	3.0	300	5.2	0.27	4.50	40	46	5.8	0.33	5.44	39	45		
120° 	1.0	100	4.0	0.20	3.38	38	43	4.6	0.27	4.48	38	43		
	1.5	150	4.3	0.24	4.03	39	45	4.9	0.31	5.17	38	44		
	2.1	210	4.6	0.29	4.76	40	46	5.2	0.36	5.94	39	45		
	2.5	250	4.9	0.32	5.34	40	46	5.5	0.39	6.56	39	45		
	3.0	300	5.2	0.36	6.00	40	46	5.8	0.43	7.25	39	45		
180° 	1.0	100	4.0	0.30	5.07	38	43	4.6	0.40	6.71	38	43		
	1.5	150	4.3	0.36	6.05	39	45	4.9	0.47	7.75	38	44		
	2.1	210	4.6	0.43	7.14	40	46	5.2	0.53	8.91	39	45		
	2.5	250	4.9	0.48	8.02	40	46	5.5	0.59	9.83	39	45		
	3.0	300	5.2	0.54	9.00	40	46	5.8	0.65	10.87	39	45		
240° 	1.0	100	4.0	0.41	6.76	38	43	4.6	0.54	8.95	38	43		
	1.5	150	4.3	0.48	8.07	39	45	4.9	0.62	10.34	38	44		
	2.1	210	4.6	0.57	9.52	40	46	5.2	0.71	11.88	39	45		
	2.5	250	4.9	0.64	10.69	40	46	5.5	0.79	13.11	39	45		
	3.0	300	5.2	0.72	12.00	40	46	5.8	0.87	14.50	39	45		
270° 	1.0	100	4.0	0.46	7.60	38	43	4.6	0.60	10.07	38	43		
	1.5	150	4.3	0.54	9.08	39	45	4.9	0.70	11.63	38	44		
	2.1	210	4.6	0.64	10.71	40	46	5.2	0.80	13.36	39	45		
	2.5	250	4.9	0.72	12.03	40	46	5.5	0.89	14.75	39	45		
	3.0	300	5.2	0.81	13.50	40	46	5.8	0.98	16.31	39	45		
360° 	1.0	100	4.0	0.61	10.13	38	43	4.6	0.81	13.43	38	43		
	1.5	150	4.3	0.73	12.10	39	45	4.9	0.93	15.51	38	44		
	2.1	210	4.6	0.86	14.28	40	46	5.2	1.07	17.82	39	45		
	2.5	250	4.9	0.96	16.03	40	46	5.5	1.18	19.67	39	45		
	3.0	300	5.2	1.08	18.00	40	46	5.8	1.30	21.75	39	45		

Bold = Recommended pressure

STRIP PATTERN NOZZLE PERFORMANCE DATA

Model	Pressure		Width x Length m	Flow	
	bar	kPa		m ³ /hr	l/min
 SS-530	1.0	100	1.2 x 8.5	0.21	3.5
	1.5	150	1.5 x 9.0	0.25	4.2
	2.0	200	1.5 x 9.0	0.29	4.9
	2.1	210	1.5 x 9.1	0.30	5.0
	2.5	250	1.5 x 9.1	0.33	5.5

Bold = Recommended pressure

PRO-SPRAY™

Meet the strongest, most versatile spray sprinkler body in the industry.

KEY BENEFITS

- Industry's strongest spray body for years of reliable performance
- Co-moulded wiper seal made from chemical- and chlorine-resistant materials
- Innovative seal design prevents cap-to-body leaks
- Heavy-duty spring for consistent riser retraction
- Check valve option eliminates low-head drainage

ADDITIONAL FEATURES

- Directional flush plug design for cleaner installation
- Interchangeable components for easier servicing, retrofits, and upgrades

OPERATING SPECIFICATIONS

- Operational pressure range: 1.0 to 7.0 bar; 100 to 700 kPa
- SASO Quality Mark Certified
- Warranty period: 5 years

FACTORY-INSTALLED OPTIONS

- Check valve available for 10 cm, 15 cm, and 30 cm models (up to 3 m of elevation)
- Reclaimed water ID cap

USER-INSTALLED OPTIONS

- Drain check valve (up to 3 m of elevation; P/N 437400SP)
- Reclaimed water ID cap (P/N 458520SP)
- Snap-on reclaimed cover (P/N PROS-RC-CAP-SP)
- Shutoff cap (P/N 213600SP)
- Shutoff nozzle (P/N 916400SP)



Pro-Spray Reclaimed

Pro-Spray models include optional factory-installed purple reclaimed caps.

PRO-SPRAY - SPECIFICATION BUILDER: ORDER 1 + 2

1 Model	2 Options
PROS-00 = Shrub adapter	(blank) = No option
PROS-02 = 5 cm pop-up	CV = Factory-installed drain check valve (Pop-up models only)
PROS-03 = 7.5 cm pop-up	R = Factory-installed reclaimed body cap (shrub moulded in purple)
PROS-04 = 10 cm pop-up	
PROS-06 = 15 cm pop-up (no side inlet)	
PROS-12 = 30 cm pop-up (no side inlet)	

PRO-SPRAY (SIDE INLET) MODELS

- PROS-06-SI** = 15 cm pop-up with side inlet
- PROS-12-SI** = 30 cm pop-up with side inlet

Examples:

- PROS-06-CV = 15 cm pop-up, drain check valve
- PROS-12-CV-R = 30 cm pop-up, drain check valve, reclaimed body cap



PROS-00

Retracted height: 4 cm
Inlet size: ½"



PROS-02

Retracted height: 10 cm
Pop-up height: 5 cm
Exposed diameter: 5.7 cm
Inlet size: ½"



PROS-03

Retracted height: 12.5 cm
Pop-up height: 7.5 cm
Exposed diameter: 5.7 cm
Inlet size: ½"



PROS-04

Retracted height: 15.5 cm
Pop-up height: 10 cm
Exposed diameter: 5.7 cm
Inlet size: ½"



[A] PROS-06-SI

[B] **PROS-06**
Retracted height: 22.5 cm
Pop-up height: 15 cm
Exposed diameter: 5.7 cm
Inlet size: ½"



[A] PROS-12-SI

[B] **PROS-12**
Retracted height: 41 cm
Pop-up height: 30 cm
Exposed diameter: 5.7 cm
Inlet size: ½"

PRO-SPRAY™ PRS30

To maintain consistent performance and reduce water waste, the Pro-Spray PRS30 Sprinkler Body is pressure-regulated to an optimal pressure of 2.1 bar; 210 kPa.

KEY BENEFITS

- Industry's strongest sprinkler body for years of reliable performance
- Pressure-regulated to 2.1 bar; 210 kPa for optimal nozzle performance
- Brown cap for easy field identification
- Co-moulded wiper seal made from chemical- and chlorine-resistant materials
- Innovative seal design prevents cap-to-body leaks, even with a loose cap
- FloGuard™ Technology option eliminates water waste in the event of a missing nozzle

ADDITIONAL FEATURES

- Directional flush plug design for cleaner installation
- Interchangeable components for easier servicing, retrofits, and upgrades
- Heavy-duty spring for consistent riser retraction
- Check valve option eliminates low-head drainage

OPERATING SPECIFICATIONS

- Operational pressure range: 1.0 to 7.0 bar; 100 to 700 kPa
- *SASO Quality Mark Certified
- Warranty period: 5 years

FACTORY-INSTALLED OPTIONS

- Check valve available for 10 cm, 15 cm, and 30 cm models (up to 4.3 m of elevation)
- Reclaimed water identification
- FloGuard Technology available for check valve models

USER-INSTALLED OPTIONS

- Check valve: P/N 437400SP
 - Up to 3 m of elevation for 7.5 cm model
 - Up to 4.3 m of elevation for 10 cm, 15 cm, and 30 cm models
- Reclaimed water ID cap: P/N 458560SP
- Snap-on reclaimed cover: P/N PROS-RC-CAP-SP
- Shutoff cap: P/N 213600SP
- Shutoff nozzle: P/N 916400SP



PRS30 Reclaimed

PRS30 models include optional factory-installed purple reclaimed caps



FloGuard Technology

Eliminate water waste in the event of a missing nozzle



Smart WaterMark

Recognised as a responsible water-saving tool



PROS-00-PRS30*
Retracted height: 11 cm
Inlet size: ½"



PROS-03-PRS30
Retracted height: 12.5 cm
Pop-up height: 7.5 cm
Exposed diameter: 5.7 cm
Inlet size: ½"



PROS-04-PRS30*
Retracted height: 15.5 cm
Pop-up height: 10 cm
Exposed diameter: 5.7 cm
Inlet size: ½"



[A] **PROS-06-SI-PRS30***
[B] **PROS-06-PRS30***
Retracted height: 22.5 cm
Pop-up height: 15 cm
Exposed diameter: 5.7 cm
Inlet size: ½"

[A] **PROS-12-SI-PRS30***
[B] **PROS-12-PRS30***
Retracted height: 41 cm
Pop-up height: 30 cm
Exposed diameter: 5.7 cm
Inlet size: ½"

PRO-SPRAY PRS30 – SPECIFICATION BUILDER: ORDER 1 + 2 + 3

1 Model	2 Feature Options	3 Specialty Options
<p>PROS-00-PRS30 = 2.1 bar regulated shrub adapter</p> <p>PROS-03-PRS30 = 2.1 bar regulated 7.5 cm pop-up</p> <p>PROS-04-PRS30 = 2.1 bar regulated 10 cm pop-up</p> <p>PROS-06-PRS30 = 2.1 bar regulated 15 cm pop-up</p> <p>PROS-12-PRS30 = 2.1 bar regulated 30 cm pop-up</p>	<p>(blank) = No option</p> <p>CV = Factory-installed drain check valve (10 cm, 15 cm, 30 cm models only)</p>	<p>(blank) = No option</p> <p>R = Factory-installed reclaimed body cap</p> <p>F = FloGuard Technology (10 cm, 15 cm, 30 cm models only)</p> <p>F-R = FloGuard Technology with reclaimed body cap (10 cm, 15 cm, 30 cm models only)</p>

PRO-SPRAY PRS30 (SIDE INLET) MODELS

PROS-06-SI-PRS30 = 2.1 bar regulated 15 cm pop-up with side inlet

PROS-12-SI-PRS30 = 2.1 bar regulated 30 cm pop-up with side inlet

Examples:

- PROS-06-SI-PRS30 = 15 cm pop-up with side inlet regulated at 2.1 bar; 210 kPa
- PROS-06-PRS30-CV = 15 cm pop-up regulated at 2.1 bar; 210 kPa, drain check valve
- PROS-12-PRS30-CV-F-R = 30 cm pop-up regulated at 2.1 bar; 210 kPa, drain check valve, and FloGuard Technology with reclaimed body cap

Compatible with:



Pro Adjustable Nozzles
Page 78

Pro Fixed Nozzles
Page 82

Pro High-Efficiency Nozzles
Page 76

PRO-SPRAY™ PRS40

To optimise MP Rotator™ Nozzle performance, the Pro-Spray PRS40 Sprinkler Body is pressure-regulated to 2.8 bar; 280 kPa.

KEY BENEFITS

- Industry's strongest sprinkler body for years of reliable performance
- Pressure-regulated to 2.8 bar; 280 kPa for the MP Rotator Nozzle
- Grey cap for easy field identification
- Co-moulded wiper seal made from chemical- and chlorine-resistant materials
- Innovative seal design prevents cap-to-body leaks, even with a loose cap
- FloGuard™ Technology option eliminates water waste in the event of a missing nozzle

ADDITIONAL FEATURES

- Directional flush plug design for cleaner installation
- Interchangeable components for easier servicing, retrofits, and upgrades
- Heavy-duty spring for consistent riser retraction
- Check valve option eliminates low-head drainage

OPERATING SPECIFICATIONS

- Operational pressure range: 1.0 to 7.0 bar; 100 to 700 kPa
- *SASO Quality Mark Certified
- Warranty period: 5 years

FACTORY-INSTALLED OPTIONS

- Check valve available for 10 cm, 15 cm, and 30 cm models (up to 4.3 m of elevation)
- Reclaimed water identification
- FloGuard Technology available for pop-up models

USER-INSTALLED OPTIONS

- Check valve: P/N 437400SP
 - Up to 3 m of elevation for 7.5 cm model
 - Up to 4.3 m of elevation for 10 cm, 15 cm, and 30 cm models
- Reclaimed water ID cap: P/N 458562SP
- Snap-on reclaimed cover: P/N PROS-RC-CAP-SP
- Shutoff cap: P/N 213600SP
- Shutoff nozzle: P/N 916400SP



PRS40 Reclaimed

PRS40 models include optional factory-installed purple reclaimed caps



FloGuard Technology

Eliminate water waste in the event of a missing nozzle



Smart WaterMark

Recognised as a responsible water-saving tool



PROS-00-PRS40*
Retracted height: 11 cm
Inlet size: ½"



PROS-03-PRS40
Retracted height: 12.5 cm
Pop-up height: 7.5 cm
Exposed diameter: 5.7 cm
Inlet size: ½"



PROS-04-PRS40-CV*
Retracted height: 15.5 cm
Pop-up height: 10 cm
Exposed diameter: 5.7 cm
Inlet size: ½"



PROS-06-PRS40-CV*
Retracted height: 22.5 cm
Pop-up height: 15 cm
Exposed diameter: 5.7 cm
Inlet size: ½"



PROS-12-PRS40-CV*
Retracted height: 41 cm
Pop-up height: 30 cm
Exposed diameter: 5.7 cm
Inlet size: ½"

PRO-SPRAY PRS40 – SPECIFICATION BUILDER: ORDER 1 + 2 + 3

1 Model	2 Feature Options	3 Specialty Options
<p>PROS-00-PRS40 = 2.8 bar regulated shrub adapter</p> <p>PROS-03-PRS40 = 2.8 bar regulated 7.5 cm pop-up</p> <p>PROS-04-PRS40 = 2.8 bar regulated 10 cm pop-up</p> <p>PROS-06-PRS40 = 2.8 bar regulated 15 cm pop-up</p> <p>PROS-12-PRS40 = 2.8 bar regulated 30 cm pop-up</p>	<p>(blank) = No option</p> <p>CV = Factory-installed drain check valve (10 cm, 15 cm, 30 cm models only)</p>	<p>(blank) = No option</p> <p>R = Factory-installed reclaimed body cap</p> <p>F = FloGuard Technology (10 cm, 15 cm, 30 cm models only)</p> <p>F-R = FloGuard Technology with reclaimed body cap (10 cm, 15 cm, 30 cm models only)</p>

PRO-SPRAY PRS40 (SIDE INLET) MODELS

PROS-06-SI-PRS40 = 2.8 bar regulated 15 cm pop-up with side inlet

PROS-12-SI-PRS40 = 2.8 bar regulated 30 cm pop-up with side inlet

Examples:

PROS-06-SI-PRS40 = 15 cm pop-up with side inlet regulated at 2.8 bar; 280 kPa

PROS-06-PRS40-CV = 15 cm pop-up regulated at 2.8 bar; 280 kPa, drain check valve

PROS-12-PRS40-CV-F-R = 30 cm pop-up regulated at 2.8 bar; 280 kPa, drain check valve, and FloGuard Technology with reclaimed body cap

Compatible with:



MP Rotator Nozzles
Page 54

SPRAY ACCESSORIES

Spray accessories provide additional flexibility for installation and maintenance of spray systems.

SJ SWING JOINTS

Features

- Unique swivel ells on both ends for easy installation in any configuration
- Swing joints are built with air-tight connection points for long-term reliability

Models

- SJ-506: 1/2" threaded x 15 cm length
- SJ-7506: 1/2" x 3/4" threaded x 15 cm length
- SJ-706: 3/4" threaded x 15 cm length
- SJ-512: 1/2" threaded x 30 cm length
- SJ-7512: 1/2" x 3/4" threaded x 30 cm length
- SJ-712: 3/4" threaded x 30 cm length

Operating Specifications

- Pressure-rated to 10 bar; 1000 kPa
- Warranty period: 2 years



SJ Swing Joints

15 cm or 30 cm links

HUNTER SPIRAL BARB ELBOWS

Features

- Improved bigger, stronger design
- Spiral-to-barb design for easier installation
- Acetal material for sharp barbs
- Compatible with FlexSG Tubing and other brands for a customised swing joint

Models

- HSBE-050: 1/2" male x spiral barb elbow
- HSBE-075: 3/4" male x spiral barb elbow

Operating Specifications

- Operating pressure: Up to 5.5 bar; 550 kPa
- Warranty period: 2 years



Spiral Barb Elbows

HSBE-050, HSBE-075

FLEXSG TUBING

Features

- Engineered to resist kinking
- Textured for easy grip
- Linear low-density polyethylene material
- Meets ASTM D2104, D2239, D2737

Models

- FLEXSG: 30 m roll
- FLEXSG-18: 45 cm pre-cut lengths

Operating Specifications

- Operating pressure: up to 5.5 bar; 550 kPa
- Warranty period: 2 years



FlexSG Tubing

30 m and 45 cm precut lengths
Inside diameter: 1.2 cm

PRO-SPRAY SHUTOFF CAP

Features

- Caps off the Pro-Spray Sprinkler Body for maintenance or drip conversions
- Maintains a clean look to the landscape

Models

- P/N 213600SP

SHUTOFF NOZZLE

Features

- Easy shutoff for spray systems
- Allows heads to pop-up for easy visibility
- Use with Pro-Spray and PS Ultra models

Models

- P/N 916400SP



Pro-Spray Shutoff Cap

P/N 213600SP



Shutoff Nozzle

P/N 916400SP

NOZZLES



PRO HIGH-EFFICIENCY NOZZLES

Pro High-Efficiency Nozzles provide increased efficiency for spray systems through high uniformity from the spray pattern at a matched precipitation rate across the line.

KEY BENEFITS

- High-efficiency performance from a high-uniformity spray pattern
- Matched precipitation of 40 mm/hr from 2.4 m to 5.2 m across the 0° to 360° adjustable arc range
- Smooth spray pattern with well-defined edges for targeted landscape irrigation
- Colour-coded with natural hues to blend with the landscape and provide easy field identification

ADDITIONAL FEATURES

- Simple arc adjustment using the easy-grip nozzle top
- Thick nozzle top offers long-lasting durability against equipment damage
- Fast installation with clear identification of spray pattern edges

OPERATING SPECIFICATIONS

- Recommended operating pressure: 2.1 bar; 210 kPa
- Pair with Pro-Spray™ PRS30 Sprinkler Bodies for pressure regulation to 2.1 bar; 210 kPa
- Warranty period: 2 years



8A-HE Nozzle
Radius: 2.4 m



10A-HE Nozzle
Radius: 3.0 m



12A-HE Nozzle
Radius: 3.7 m



15A-HE Nozzle
Radius: 4.6 m



17A-HE Nozzle
Radius: 5.2 m

PRO HIGH-EFFICIENCY NOZZLES PERFORMANCE DATA



8A-HE

● Olive Green

2.4 m radius
Adjustable from 0° to 360°
Trajectory: 20°

10A-HE

● Dark Blue

3.0 m radius
Adjustable from 0° to 360°
Trajectory: 25°

12A-HE

● Brown

3.7 m radius
Adjustable from 0° to 360°
Trajectory: 25°

Arc	Pressure		Radius m	Flow		Precip mm/hr		Radius m	Flow		Precip mm/hr		Radius m	Flow		Precip mm/hr	
	bar	kPa		m ³ /hr	l/min	■	▲		m ³ /hr	l/min	■	▲		m ³ /hr	l/min	■	▲
90° 	1.0	100	2.0	0.05	0.87	52	60	2.7	0.08	1.36	45	52	3.3	0.12	2.01	44	51
	1.5	150	2.2	0.06	1.02	51	59	2.8	0.09	1.55	48	55	3.5	0.13	2.23	44	51
	2.1	210	2.4	0.06	1.06	44	51	3.0	0.10	1.67	44	51	3.7	0.14	2.38	42	48
	2.5	250	2.6	0.07	1.21	43	50	3.1	0.11	1.82	45	52	3.8	0.16	2.65	44	51
	3.0	300	2.8	0.08	1.32	41	47	3.2	0.12	1.93	45	52	3.9	0.17	2.84	45	52
180° 	1.0	100	2.0	0.10	1.65	49	57	2.7	0.16	2.65	44	50	3.3	0.23	3.88	43	49
	1.5	150	2.2	0.11	1.85	46	53	2.8	0.18	2.94	45	52	3.5	0.25	4.24	42	48
	2.1	210	2.4	0.12	2.08	43	50	3.0	0.19	3.24	43	50	3.7	0.28	4.62	40	47
	2.5	250	2.6	0.14	2.37	42	48	3.1	0.21	3.52	44	51	3.8	0.30	5.03	42	48
	3.0	300	2.8	0.15	2.57	39	45	3.2	0.23	3.79	44	51	3.9	0.33	5.53	44	50
270° 	1.0	100	2.0	0.15	2.47	49	57	2.7	0.24	3.97	44	50	3.3	0.35	5.82	43	49
	1.5	150	2.2	0.17	2.78	46	53	2.8	0.26	4.41	45	52	3.5	0.38	6.36	42	48
	2.1	210	2.4	0.19	3.11	43	50	3.0	0.29	4.85	43	50	3.7	0.42	6.93	40	47
	2.5	250	2.6	0.21	3.55	42	48	3.1	0.32	5.28	44	51	3.8	0.45	7.55	42	48
	3.0	300	2.8	0.23	3.86	39	45	3.2	0.34	5.68	44	51	3.9	0.50	8.29	44	50
360° 	1.0	100	2.0	0.20	3.29	49	57	2.7	0.32	5.30	44	50	3.3	0.47	7.76	43	49
	1.5	150	2.2	0.22	3.71	46	53	2.8	0.35	5.88	45	52	3.5	0.51	8.48	42	48
	2.1	210	2.4	0.25	4.15	43	50	3.0	0.39	6.47	43	50	3.7	0.55	9.24	40	47
	2.5	250	2.6	0.28	4.73	42	48	3.1	0.42	7.04	44	51	3.8	0.60	10.07	42	48
	3.0	300	2.8	0.31	5.50	39	45	3.2	0.45	7.57	44	51	3.9	0.66	11.05	44	50

PRO HIGH-EFFICIENCY NOZZLES PERFORMANCE DATA



15A-HE 4.6 m radius
Adjustable from 0° to 360°
Trajectory: 25°
● Black

17A-HE 5.2 m radius
Adjustable from 0° to 360°
Trajectory: 25°
● Grey

Arc	Pressure		Radius m	Flow		Precip mm/hr		Radius m	Flow		Precip mm/hr	
	bar	kPa		m ³ /hr	l/min	■	▲		m ³ /hr	l/min	■	▲
90° 	1.0	100	4.2	0.18	2.95	40	46	4.6	0.22	3.61	41	47
	1.5	150	4.4	0.20	3.33	41	48	4.8	0.24	4.04	42	49
	2.1	210	4.6	0.22	3.63	41	48	5.2	0.28	4.69	42	48
	2.5	250	4.7	0.24	4.05	44	51	5.3	0.29	4.90	42	48
	3.0	300	4.8	0.26	4.28	45	51	5.4	0.31	5.25	43	50
180° 	1.0	100	4.2	0.35	5.78	39	45	4.6	0.40	6.68	38	44
	1.5	150	4.4	0.38	6.38	40	46	4.8	0.46	7.70	40	46
	2.1	210	4.6	0.42	7.08	40	46	5.2	0.54	8.93	40	46
	2.5	250	4.7	0.47	7.76	42	49	5.3	0.56	9.33	40	46
	3.0	300	4.8	0.50	8.39	44	50	5.4	0.60	10.03	41	48
270° 	1.0	100	4.2	0.52	8.67	39	45	4.6	0.60	10.02	38	44
	1.5	150	4.4	0.57	9.58	40	46	4.8	0.69	11.55	40	46
	2.1	210	4.6	0.64	10.62	40	46	5.2	0.80	13.40	40	46
	2.5	250	4.7	0.70	11.64	42	49	5.3	0.84	14.00	40	46
	3.0	300	4.8	0.75	12.59	44	50	5.4	0.90	15.05	41	48
360° 	1.0	100	4.2	0.69	11.56	39	45	4.6	0.80	13.36	38	44
	1.5	150	4.4	0.77	12.77	40	46	4.8	0.92	15.40	40	46
	2.1	210	4.6	0.85	14.16	40	46	5.2	1.07	17.87	40	46
	2.5	250	4.7	0.93	15.52	42	49	5.3	1.12	18.66	40	46
	3.0	300	4.8	1.01	16.78	44	50	5.4	1.20	20.06	41	48

Bold = Recommended pressure

Note: The Pro-Spray PRS30 Sprinkler Body's built-in pressure regulator controls output to a maximum of 2.1 bar; 210 kPa. Adjusting the radius reduction screw may be required to achieve catalogue radius and flow.

Pro High-Efficiency Nozzles

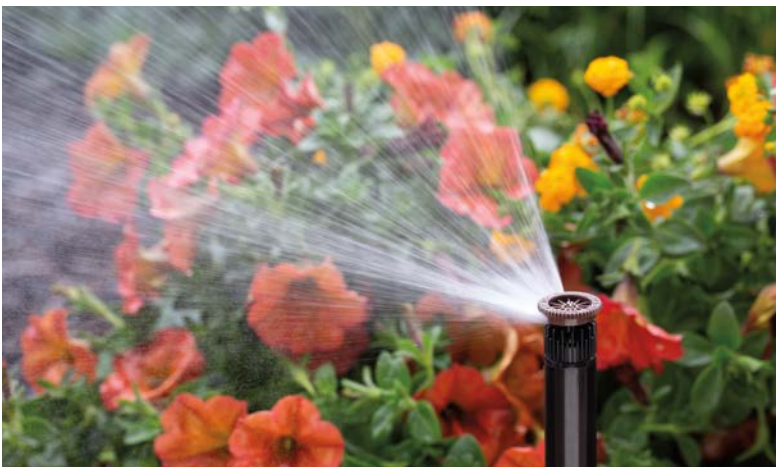

PRO ADJUSTABLE NOZZLES

Choose Pro Adjustable Nozzles for excellent landscape coverage in any setting.

KEY BENEFITS

- Adjustable from 0° to 360° for maximum design flexibility
- Easy-grip top for simple adjustment
- Strong edges for a defined pattern with better wind resistance
- Large water droplets minimise misting with better uniformity

ADDITIONAL FEATURES

- Matched precipitation rate on each nozzle from 8A to 17A
- Even distribution results in better coverage
- Colour-coded for easy field identification

OPERATING SPECIFICATIONS

- Recommended operating pressure: 2.1 bar; 210 kPa
- Pair with Pro-Spray PRS30 pop-up for pressure regulation to 2.1 bar; 210 kPa
- Warranty period: 2 years



4A Nozzle
Radius: 1.2 m



6A Nozzle
Radius: 1.8 m



8A Nozzle
Radius: 2.4 m



10A Nozzle
Radius: 3.0 m



12A Nozzle
Radius: 3.7 m



15A Nozzle
Radius: 4.6 m



17A Nozzle
Radius: 5.2 m

Pro Adjustable Nozzle



PRO ADJUSTABLE NOZZLES PERFORMANCE DATA



4A 1.2 m radius
Adjustable from 0° to 360°
● Lt. Green Trajectory: 0°

6A 1.8 m radius
Adjustable from 0° to 360°
● Lt. Blue Trajectory: 0°

8A 2.4 m radius
Adjustable from 0° to 360°
● Brown Trajectory: 15°

Arc	Pressure		Radius m	Flow		Precip mm/hr		Radius m	Flow		Precip mm/hr		Radius m	Flow		Precip mm/hr	
	bar	kPa		m ³ /hr	l/min	■	▲		m ³ /hr	l/min	■	▲		m ³ /hr	l/min	■	▲
45° ▶	1.0	100	0.9	0.02	0.31	187	216	1.5	0.03	0.54	117	136	2.0	0.04	0.62	77	89
	1.5	150	1.0	0.02	0.39	178	206	1.6	0.04	0.60	108	124	2.2	0.04	0.72	72	83
	2.1	210	1.2	0.03	0.48	167	193	1.8	0.04	0.65	98	114	2.4	0.05	0.83	67	77
	2.5	250	1.3	0.03	0.56	158	183	1.9	0.04	0.70	92	106	2.6	0.05	0.91	63	73
	3.0	300	1.4	0.04	0.64	149	172	2.1	0.05	0.75	86	99	2.9	0.06	1.01	59	68
90° ◑	1.0	100	0.9	0.04	0.72	213	246	1.5	0.06	1.08	116	134	2.0	0.07	1.24	77	89
	1.5	150	1.0	0.05	0.76	182	210	1.6	0.07	1.21	109	126	2.2	0.09	1.44	72	83
	2.1	210	1.2	0.05	0.83	139	160	1.8	0.08	1.35	102	118	2.4	0.10	1.65	67	77
	2.5	250	1.3	0.05	0.91	129	149	1.9	0.09	1.47	97	112	2.6	0.11	1.82	63	73
	3.0	300	1.4	0.06	0.95	116	134	2.1	0.10	1.61	92	106	2.9	0.12	2.02	59	68
120° ◐	1.0	100	0.9	0.06	0.97	221	255	1.5	0.08	1.26	102	118	2.0	0.10	1.66	77	89
	1.5	150	1.0	0.07	1.10	188	217	1.6	0.09	1.43	97	112	2.2	0.11	1.92	72	83
	2.1	210	1.2	0.07	1.25	162	187	1.8	0.10	1.61	91	105	2.4	0.13	2.20	67	77
	2.5	250	1.3	0.08	1.36	146	168	1.9	0.11	1.76	87	100	2.6	0.15	2.43	63	73
	3.0	300	1.4	0.09	1.49	131	151	2.1	0.12	1.93	82	95	2.9	0.16	2.69	59	68
180° ◔	1.0	100	0.9	0.07	1.18	178	206	1.5	0.10	1.70	92	106	2.0	0.15	2.49	77	89
	1.5	150	1.0	0.08	1.38	157	181	1.6	0.12	1.96	88	102	2.2	0.17	2.87	72	83
	2.1	210	1.2	0.10	1.60	139	160	1.8	0.13	2.24	84	97	2.4	0.20	3.30	67	77
	2.5	250	1.3	0.11	1.78	127	146	1.9	0.15	2.47	81	94	2.6	0.22	3.65	63	73
	3.0	300	1.4	0.12	1.98	115	133	2.1	0.16	2.72	78	90	2.9	0.24	4.03	59	68
240° ◓	1.0	100	0.9	0.12	1.94	220	254	1.5	0.15	2.44	99	114	2.0	0.20	3.32	77	89
	1.5	150	1.0	0.13	2.24	192	221	1.6	0.17	2.83	96	111	2.2	0.23	3.83	72	83
	2.1	210	1.2	0.16	2.59	168	194	1.8	0.20	3.28	92	107	2.4	0.26	4.40	67	77
	2.5	250	1.3	0.17	2.86	153	177	1.9	0.22	3.63	89	103	2.6	0.29	4.86	63	73
	3.0	300	1.4	0.19	3.17	139	160	2.1	0.24	4.03	86	99	2.9	0.32	5.38	59	68
270° ◒	1.0	100	0.9	0.13	2.09	211	244	1.5	0.18	3.08	111	128	2.0	0.22	3.73	77	89
	1.5	150	1.0	0.14	2.40	183	211	1.6	0.21	3.52	106	122	2.2	0.26	4.31	72	83
	2.1	210	1.2	0.16	2.75	159	183	1.8	0.24	4.02	101	116	2.4	0.30	4.95	67	77
	2.5	250	1.3	0.18	3.02	144	166	1.9	0.27	4.42	97	112	2.6	0.33	5.47	63	73
	3.0	300	1.4	0.20	3.33	130	150	2.1	0.29	4.87	92	107	2.9	0.36	6.05	59	68
360° ●	1.0	100	0.9	0.14	2.26	171	197	1.5	0.21	3.57	96	111	2.0	0.30	4.97	77	89
	1.5	150	1.0	0.16	2.60	148	171	1.6	0.24	4.07	92	106	2.2	0.34	5.75	72	83
	2.1	210	1.2	0.18	2.98	129	149	1.8	0.28	4.62	87	100	2.4	0.40	6.61	67	77
	2.5	250	1.3	0.20	3.29	117	135	1.9	0.30	5.06	83	96	2.6	0.44	7.29	63	73
	3.0	300	1.4	0.22	3.63	106	122	2.1	0.33	5.56	79	92	2.9	0.48	8.07	59	68

Bold = Recommended pressure

Note: The Pro-Spray PRS30's built-in pressure regulator controls output to a maximum of 2.1 bar; 210 kPa. Adjusting the radius reduction screw may be required to achieve catalogue radius and flow.

PRO ADJUSTABLE NOZZLES PERFORMANCE DATA



10A 3.0 m radius
Adjustable from 0° to 360°
● Red Trajectory: 15°



12A 3.7 m radius
Adjustable from 0° to 360°
● Green Trajectory: 28°



15A 4.6 m radius
Adjustable from 0° to 360°
● Black Trajectory: 28°

Arc	Pressure		Radius m	Flow		Precip mm/hr		Radius m	Flow		Precip mm/hr		Radius m	Flow		Precip mm/hr	
	bar	kPa		m ³ /hr	l/min	■	▲		m ³ /hr	l/min	■	▲		m ³ /hr	l/min	■	▲
45° ▶	1.0	100	2.6	0.04	0.68	49	56	3.2	0.04	0.73	34	40	4.0	0.08	1.27	38	43
	1.5	150	2.8	0.05	0.80	49	57	3.4	0.06	0.97	40	46	4.3	0.09	1.51	39	45
	2.1	210	3.0	0.06	0.94	49	56	3.7	0.07	1.23	44	51	4.6	0.11	1.79	40	46
	2.5	250	3.2	0.06	1.06	48	56	3.9	0.09	1.44	46	54	4.9	0.12	2.00	40	46
	3.0	300	3.5	0.07	1.18	47	54	4.1	0.10	1.68	48	56	5.2	0.14	2.25	40	46
90° ◐	1.0	100	2.6	0.08	1.35	49	56	3.2	0.09	1.46	34	40	4.0	0.15	2.53	38	43
	1.5	150	2.8	0.10	1.61	49	57	3.4	0.12	1.93	40	46	4.3	0.18	3.03	39	45
	2.1	210	3.0	0.11	1.89	49	56	3.7	0.15	2.46	44	51	4.6	0.21	3.57	40	46
	2.5	250	3.2	0.13	2.11	48	56	3.9	0.17	2.88	46	54	4.9	0.24	4.01	40	46
	3.0	300	3.5	0.14	2.37	47	54	4.1	0.20	3.36	48	56	5.2	0.27	4.50	40	46
120° ◑	1.0	100	2.6	0.11	1.80	49	56	3.2	0.12	1.94	34	40	4.0	0.20	3.38	38	43
	1.5	150	2.8	0.13	2.14	49	57	3.4	0.15	2.58	40	46	4.3	0.24	4.03	39	45
	2.1	210	3.0	0.15	2.52	49	56	3.7	0.20	3.28	44	51	4.6	0.29	4.76	40	46
	2.5	250	3.2	0.17	2.82	48	56	3.9	0.23	3.84	46	54	4.9	0.32	5.34	40	46
	3.0	300	3.5	0.19	3.16	47	54	4.1	0.27	4.48	48	56	5.2	0.36	6.00	40	46
180° ◒	1.0	100	2.6	0.16	2.71	49	56	3.2	0.17	2.91	34	40	4.0	0.30	5.07	38	43
	1.5	150	2.8	0.19	3.21	49	57	3.4	0.23	3.86	40	46	4.3	0.36	6.05	39	45
	2.1	210	3.0	0.23	3.78	49	56	3.7	0.30	4.92	44	51	4.6	0.43	7.14	40	46
	2.5	250	3.2	0.25	4.23	48	56	3.9	0.35	5.76	46	54	4.9	0.48	8.02	40	46
	3.0	300	3.5	0.28	4.73	47	54	4.1	0.40	6.71	48	56	5.2	0.54	9.00	40	46
240° ◓	1.0	100	2.6	0.22	3.61	49	56	3.2	0.23	3.88	34	40	4.0	0.41	6.76	38	43
	1.5	150	2.8	0.26	4.28	49	57	3.4	0.31	5.15	40	46	4.3	0.48	8.07	39	45
	2.1	210	3.0	0.30	5.03	49	56	3.7	0.39	6.56	44	51	4.6	0.57	9.52	40	46
	2.5	250	3.2	0.34	5.64	48	56	3.9	0.46	7.68	46	54	4.9	0.64	10.69	40	46
	3.0	300	3.5	0.38	6.31	47	54	4.1	0.54	8.95	48	56	5.2	0.72	12.00	40	46
270° ◔	1.0	100	2.6	0.24	4.06	49	56	3.2	0.26	4.37	34	40	4.0	0.46	7.60	38	43
	1.5	150	2.8	0.29	4.82	49	57	3.4	0.35	5.80	40	46	4.3	0.54	9.08	39	45
	2.1	210	3.0	0.34	5.66	49	56	3.7	0.44	7.38	44	51	4.6	0.64	10.71	40	46
	2.5	250	3.2	0.38	6.34	48	56	3.9	0.52	8.65	46	54	4.9	0.72	12.03	40	46
	3.0	300	3.5	0.43	7.10	47	54	4.1	0.60	10.07	48	56	5.2	0.81	13.50	40	46
360° ◕	1.0	100	2.6	0.32	5.41	49	56	3.2	0.35	5.83	34	40	4.0	0.61	10.13	38	43
	1.5	150	2.8	0.39	6.43	49	57	3.4	0.46	7.73	40	46	4.3	0.73	12.10	39	45
	2.1	210	3.0	0.45	7.55	49	56	3.7	0.59	9.84	44	51	4.6	0.86	14.28	40	46
	2.5	250	3.2	0.51	8.45	48	56	3.9	0.69	11.53	46	54	4.9	0.96	16.03	40	46
	3.0	300	3.5	0.57	9.47	47	54	4.1	0.81	13.43	48	56	5.2	1.08	18.00	40	46

Bold = Recommended pressure

Note: The Pro-Spray PRS30's built-in pressure regulator controls output to a maximum of 2.1 bar; 210 kPa. Adjusting the radius reduction screw may be required to achieve catalogue radius and flow.

PRO ADJUSTABLE NOZZLES PERFORMANCE DATA



17A 5.2 m radius
Adjustable from 0° to 360°
● Grey Trajectory: 28°

Arc	Pressure		Radius m	Flow		Precip mm/hr	
	bar	kPa		m ³ /hr	l/min	■	▲
45° ▶	1.0	100	4.6	0.10	1.68	38	43
	1.5	150	4.9	0.12	1.94	38	44
	2.1	210	5.2	0.13	2.23	39	45
	2.5	250	5.5	0.15	2.46	39	45
	3.0	300	5.8	0.16	2.72	39	45
90° ◑	1.0	100	4.6	0.20	3.36	38	43
	1.5	150	4.9	0.23	3.88	38	44
	2.1	210	5.2	0.27	4.45	39	45
	2.5	250	5.5	0.30	4.92	39	45
	3.0	300	5.8	0.33	5.44	39	45
120° ◐	1.0	100	4.6	0.27	4.48	38	43
	1.5	150	4.9	0.31	5.17	38	44
	2.1	210	5.2	0.36	5.94	39	45
	2.5	250	5.5	0.39	6.56	39	45
	3.0	300	5.8	0.43	7.25	39	45
180° ◕	1.0	100	4.6	0.40	6.71	38	43
	1.5	150	4.9	0.47	7.75	38	44
	2.1	210	5.2	0.53	8.91	39	45
	2.5	250	5.5	0.59	9.83	39	45
	3.0	300	5.8	0.65	10.87	39	45
240° ◔	1.0	100	4.6	0.54	8.95	38	43
	1.5	150	4.9	0.62	10.34	38	44
	2.1	210	5.2	0.71	11.88	39	45
	2.5	250	5.5	0.79	13.11	39	45
	3.0	300	5.8	0.87	14.50	39	45
270° ◓	1.0	100	4.6	0.60	10.07	38	43
	1.5	150	4.9	0.70	11.63	38	44
	2.1	210	5.2	0.80	13.36	39	45
	2.5	250	5.5	0.89	14.75	39	45
	3.0	300	5.8	0.98	16.31	39	45
360° ●	1.0	100	4.6	0.81	13.43	38	43
	1.5	150	4.9	0.93	15.51	38	44
	2.1	210	5.2	1.07	17.82	39	45
	2.5	250	5.5	1.18	19.67	39	45
	3.0	300	5.8	1.30	21.75	39	45

Bold = Recommended pressure

Note: The Pro-Spray PRS30's built-in pressure regulator controls output to a maximum of 2.1 bar; 210 kPa. Adjusting the radius reduction screw may be required to achieve catalogue radius and flow.

PRO FIXED NOZZLES

Pro Fixed Nozzles are designed for high accuracy within a variety of landscape shapes and sizes.

KEY BENEFITS

- Clean edges for a defined pattern with better wind resistance
- Large water droplets minimise misting with better uniformity
- Sturdy construction ensures reliable performance
- Colour-coded for easy field identification

OPERATING SPECIFICATIONS

- Recommended operating pressure: 2.1 bar; 210 kPa
- Pair with Pro-Spray™ PRS30 Sprinkler Bodies for pressure regulation to 2.1 bar; 210 kPa
- Warranty period: 2 years

PRO FIXED NOZZLES						
ARC	5	8	10	12	15	17
Q						
T	Use 4A/6A Nozzle					Use 17A Nozzle
H						
F						Use 17A Nozzle
	1.5 m	2.4 m	3.0 m	3.7 m	4.6 m	5.2 m

PRO FIXED NOZZLES PERFORMANCE DATA



5 1.5 m radius
Fixed: ¼, ½, Full
● Blue Trajectory: 0°

8 2.4 m radius
Fixed: ¼, ½, ½, Full
● Brown Trajectory: 15°

10 3.0 m radius
Fixed: ¼, ½, ½, Full
● Red Trajectory: 15°

Arc	Position	Pressure		Radius	Flow		Precip mm/hr		Radius	Flow		Precip mm/hr		Radius	Flow		Precip mm/hr				
		bar	kPa		m ³ /hr	l/min	■	▲		m	m ³ /hr	l/min	■		▲	m	m ³ /hr	l/min	■	▲	
90°	Q	1.0	100	1.1	0.02	0.30	60	69	1.8	0.04	0.62	46	53	2.4	0.07	1.08	45	52			
		1.5	150		1.3	0.02	0.38	54		62	2.1	0.05	0.84		46	53	2.7	0.08	1.33	44	51
		2.1	210		1.5	0.03	0.46	49		57	2.4	0.05	0.91		38	44	3.0	0.09	1.57	42	48
		2.5	250		1.7	0.03	0.51	42		49	2.7	0.06	0.98		32	37	3.3	0.10	1.71	38	44
		3.0	300		1.8	0.03	0.53	39		45	2.7	0.06	1.10		36	42	3.4	0.11	1.85	38	44
120°	T	1.0	100	1.1	Use 4A or 6A Nozzle				1.8	0.05	0.83	46	53	2.4	0.09	1.44	45	52			
		1.5	150							2.1	0.07	1.10	45		52	2.7	0.11	1.77	44	50	
		2.1	210							2.4	0.07	1.21	38		44	3.0	0.13	2.09	42	48	
		2.5	250							2.7	0.08	1.32	33		38	3.3	0.14	2.31	38	44	
		3.0	300							2.7	0.09	1.44	36		41	3.4	0.15	2.50	39	45	
180°	H	1.0	100	1.1	0.04	0.60	60	69	1.8	0.08	1.33	49	57	2.4	0.13	2.17	45	52			
		1.5	150		1.3	0.05	0.76	54		62	2.1	0.10	1.63		44	51	2.7	0.16	2.65	44	50
		2.1	210		1.5	0.06	0.87	49		57	2.4	0.11	1.80		38	43	3.0	0.19	3.14	42	48
		2.5	250		1.7	0.06	0.95	42		49	2.7	0.12	1.93		32	37	3.3	0.22	3.60	40	46
		3.0	300		1.8	0.06	1.04	39		44	2.7	0.13	2.10		35	40	3.4	0.23	3.90	40	47
360°	F	1.0	100	1.1	0.07	1.20	60	69	1.8	0.16	2.67	49	57	2.4	0.26	4.33	45	52			
		1.5	150		1.3	0.09	1.52	54		62	2.1	0.20	3.33		45	52	2.7	0.32	5.31	44	50
		2.1	210		1.5	0.11	1.85	49		57	2.4	0.22	3.67		38	44	3.0	0.38	6.28	42	48
		2.5	250		1.7	0.12	2.04	42		49	2.7	0.24	4.01		33	38	3.3	0.41	6.85	38	44
		3.0	300		1.8	0.12	2.10	39		45	2.7	0.26	4.35		36	41	3.4	0.42	6.97	36	42

Bold = Recommended pressure

Pro Fixed Nozzles



PRO FIXED NOZZLES PERFORMANCE DATA



12 3.7 m radius
Fixed: ¼, ⅓, ½, ⅔, ¾, Full
● Green Trajectory: 28°

15 4.6 m radius
Fixed: ¼, ⅓, ½, ⅔, ¾, Full
● Black Trajectory: 28°

17 5.2 m radius
Fixed: ¼, ½
● Grey Trajectory: 28°

Arc	Position	Pressure		Radius		Flow		Precip mm/hr		Radius		Flow		Precip mm/hr		Radius		Flow		Precip mm/hr		
		bar	kPa	m	m	m ³ /hr	l/min	■	▲	m	m ³ /hr	l/min	■	▲	m	m ³ /hr	l/min	■	▲			
90° 	Q	1.0	100	3.0	0.10	1.58	42	49	3.9	0.15	2.50	39	46	4.7	0.19	3.17	34	40				
		1.5	150	3.4	0.12	2.00	42	48	4.2	0.18	3.06	42	48	4.9	0.23	3.88	39	45				
		2.1	210	3.7	0.15	2.43	43	49	4.6	0.22	3.62	41	47	5.2	0.28	4.59	41	47				
		2.5	250	4.0	0.16	2.69	40	47	4.9	0.24	3.95	39	46	5.5	0.30	5.01	40	46				
		3.0	300	4.0	0.18	2.95	44	51	5.2	0.26	4.32	38	44	5.8	0.32	5.30	38	44				
120° 	T	1.0	100	3.0	0.13	2.11	42	49	3.9	0.20	3.33	39	46	Use 17A Nozzle								
		1.5	150	3.4	0.16	2.67	42	48	4.2	0.24	4.08	42	48									
		2.1	210	3.7	0.19	3.25	43	49	4.6	0.29	4.83	41	47									
		2.5	250	4.0	0.22	3.67	41	48	4.9	0.32	5.27	40	46									
		3.0	300	4.0	0.24	3.94	44	51	5.2	0.35	5.75	38	44									
180° 	H	1.0	100	3.0	0.19	3.17	42	49	3.9	0.30	5.00	39	46	4.7	0.38	6.33	34	40				
		1.5	150	3.4	0.24	4.01	42	48	4.2	0.37	6.12	42	48	4.9	0.47	7.76	39	45				
		2.1	210	3.7	0.29	4.87	43	49	4.6	0.43	7.25	41	47	5.2	0.55	9.18	41	47				
		2.5	250	4.0	0.32	5.39	40	47	4.9	0.47	7.91	40	46	5.5	0.60	10.01	40	46				
		3.0	300	4.0	0.35	5.75	43	50	5.2	0.49	8.18	36	42	5.8	0.64	10.06	38	44				
360° 	F	1.0	100	3.0	0.38	6.33	42	49	3.9	0.60	10.00	39	46	Use 17A Nozzle								
		1.5	150	3.4	0.48	8.01	42	48	4.2	0.73	12.25	42	48									
		2.1	210	3.7	0.58	9.74	43	49	4.6	0.87	14.49	41	47									
		2.5	250	4.0	0.65	10.78	40	47	4.9	0.95	15.81	40	46									
		3.0	300	4.0	0.70	11.73	44	51	5.2	0.99	16.50	37	42									

Bold = Recommended pressure

SHORT-RADIUS MICRO SPRAY NOZZLES

These highly accurate nozzles are perfect for small spaces and can support a robust micro spray system with Pro-Spray™ Sprinkler Bodies.

KEY BENEFITS



- Low flow for controlled irrigation of tight spaces
- Meets micro spray requirement of 114 l/hr max flow at 2.1 bar; 210 kPa
- Built to last for a robust overhead solution for small spaces

OPERATING SPECIFICATIONS



- Recommended operating pressure: 2.1 bar; 210 kPa
- Pair with Pro-Spray PRS30 pop-up for pressure regulation to 2.1 bar; 210 kPa

SHORT-RADIUS NOZZLES PERFORMANCE DATA



● Nozzle Lt. Brown

Arc	Pressure		Position	Radius m	Flow		*Precip mm/hr
	bar	kPa			l/min	l/hr	
90° 	1.0	100	2Q	0.6	0.34	20	57
	1.5	150		0.6	0.38	23	63
	2.1	210		0.6	0.42	25	70
	2.5	250		0.6	0.49	29	82
180° 	1.0	100	2H	0.6	0.53	32	44
	1.5	150		0.6	0.57	34	48
	2.1	210		0.6	0.76	46	63
	2.5	250		0.6	0.77	46	64
3.0	300	0.6	0.80	48	67		

● Nozzle Lt. Green

Arc	Pressure		Position	Radius m	Flow		*Precip mm/hr
	bar	kPa			l/min	l/hr	
90° 	1.0	100	4Q	1.2	0.68	41	28
	1.5	150		1.2	0.76	46	32
	2.1	210		1.2	0.76	46	32
	2.5	250		1.2	0.83	50	35
180° 	1.0	100	4H	1.2	1.25	75	26
	1.5	150		1.2	1.29	77	27
	2.1	210		1.2	1.51	91	31
	2.5	250		1.2	1.52	91	32
3.0	300	1.2	1.67	100	35		

● Nozzle Lt. Blue

Arc	Pressure		Position	Radius m	Flow		*Precip mm/hr
	bar	kPa			l/min	l/hr	
90° 	1.0	100	6Q	1.8	0.83	50	15
	1.5	150		1.8	0.91	55	17
	2.1	210		1.8	1.14	68	21
	2.5	250		1.8	1.14	68	21
180° 	1.0	100	6H	1.8	1.52	91	14
	1.5	150		1.8	1.67	100	15
	2.1	210		1.8	1.90	114	18
	2.5	250		1.8	1.97	118	18
3.0	300	1.8	2.05	123	19		

Bold = Recommended pressure

*Precipitation rate shown without overlap



2Q Nozzle
Radius: 0.6 m



2H Nozzle
Radius: 0.6 m



4Q Nozzle
Radius: 1.2 m



4H Nozzle
Radius: 1.2 m



6Q Nozzle
Radius: 1.8 m



6H Nozzle
Radius: 1.8 m

Short-Radius Micro Spray Nozzle

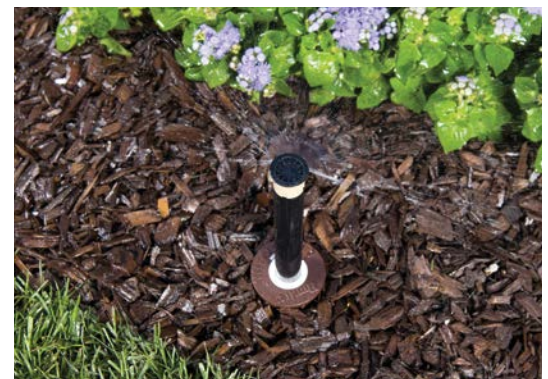

STRIP PATTERN NOZZLES

Irrigate narrow turf and planter areas accurately with fixed arc Strip Pattern Nozzles.

KEY BENEFITS

- Designed for accurate coverage of strip areas
- Available in a variety of models for unique, rectangular spaces
- Built to last in harsh conditions

OPERATING SPECIFICATIONS

- Recommended operating pressure: 2.1 bar; 210 kPa
- Pair with Pro-Spray™ PRS30 pop-up for pressure regulation to 2.1 bar; 210 kPa
- Warranty period: 2 years



Left Corner Strip
Rectangle: 1.5 m x 4.5 m



Right Corner Strip
Rectangle: 1.5 m x 4.5 m



Side Strip
Rectangle: 1.5 m x 9.1 m



Side Strip
Rectangle: 2.7 m x 5.5 m









Center Strip
Rectangle: 1.5 m x 9.1 m



End Strip
Rectangle: 1.5 m x 4.5 m

STRIP PATTERN NOZZLE PERFORMANCE DATA

Arc	Pressure		Width x Length m	Flow	
	bar	kPa		m ³ /hr	l/min
LCS-515 	1.0	100	1.2 x 4.2	0.10	1.7
	1.5	150	1.2 x 4.3	0.13	2.1
	2.1	210	1.5 x 4.5	0.15	2.5
	2.5	250	1.5 x 4.5	0.16	2.7
	3.0	300	1.5 x 4.5	0.17	2.8
RCS-515 	1.0	100	1.2 x 4.2	0.10	1.7
	1.5	150	1.2 x 4.3	0.13	2.1
	2.1	210	1.5 x 4.5	0.15	2.5
	2.5	250	1.5 x 4.5	0.16	2.7
	3.0	300	1.5 x 4.5	0.17	2.8
SS-530 	1.0	100	1.2 x 8.5	0.21	3.5
	1.5	150	1.5 x 9.0	0.25	4.2
	2.1	210	1.5 x 9.1	0.30	5.0
	2.5	250	1.5 x 9.1	0.33	5.5
	3.0	300	1.5 x 9.1	0.34	5.7
SS-918 	1.0	100	2.4 x 5.2	0.27	4.5
	1.5	150	2.7 x 5.5	0.33	5.5
	2.1	210	2.7 x 5.5	0.39	6.5
	2.5	250	2.7 x 5.5	0.43	7.1
	3.0	300	2.7 x 5.5	0.47	7.9
CS-530 	1.0	100	1.2 x 8.5	0.21	3.5
	1.5	150	1.5 x 9.0	0.25	4.2
	2.1	210	1.5 x 9.1	0.30	5.0
	2.5	250	1.5 x 9.1	0.33	5.5
	3.0	300	1.5 x 9.1	0.34	5.7
ES-515 	1.0	100	1.1 x 4.2	0.10	1.7
	1.5	150	1.2 x 4.3	0.13	2.1
	2.1	210	1.5 x 4.5	0.15	2.5
	2.5	250	1.5 x 4.5	0.16	2.7
	3.0	300	1.5 x 4.5	0.17	2.8

Bold = Recommended pressure

RCS-515





BUBBLER NOZZLES

Deliver a consistent flow regardless of inlet pressure with pressure-compensating Bubbler Nozzles.

KEY BENEFITS

- Pressure-compensating for constant water flow at any pressure
- Designed for deep watering of planted areas
- Nozzle threaded for use with Pro-Spray™ Sprinkler Bodies
- Warranty period: 2 years

MULTI-STREAM BUBBLER PERFORMANCE DATA

Arc	Model	Flow		Radius m
		m ³ /hr	l/min	
	MSBN-25Q	0.06	0.9	0.30
	MSBN-50Q	0.11	1.9	0.46
	MSBN-50H	0.11	1.9	0.30
	MSBN-10H	0.23	3.8	0.46
	MSBN-10F	0.23	3.8	0.30
	MSBN-20F	0.45	7.6	0.46

Multi-Stream Bubbler



Notes:

Typical spacing 0.6 to 1.2 m. Flows shown for pressures between 1.0 and 4.8 bar; 100 and 480 kPa.



MSBN Installed on PROS-04

Combining Hunter Bubbler Nozzles with Pro-Spray Sprinkler Bodies provides the watering precision of pressure-compensating bubblers paired with the benefit of retracting the nozzle out of sight.

MULTI-STREAM BUBBLER NOZZLES



MSBN-25Q
Flow: 0.06 m³/hr;
0.9 l/min



MSBN-50Q/50H
Flow: 0.11 m³/hr;
1.9 l/min







MSBN-10H/10F
Flow: 0.23 m³/hr;
3.8 l/min



MSBN-20F
Flow: 0.45 m³/hr;
7.6 l/min

PCN PERFORMANCE DATA

Model	Flow		Pattern Type
	m ³ /hr	l/min	
 25	0.06	0.9	Trickle
 50	0.11	1.9	Trickle
 10	0.23	3.8	Umbrella
 20	0.46	7.6	Umbrella

PCN

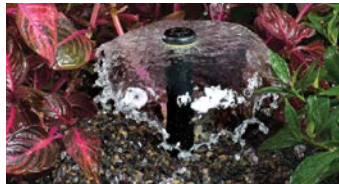

Notes:

Typical spacing 0.3 to 0.9 m. Flows shown for pressures between 1.0 and 4.8 bar; 100 and 480 kPa.

PCN BUBBLER NOZZLES



PCN-25
Flow: 0.06 m³/hr;
0.9 l/min



PCN-50
Flow: 0.11 m³/hr;
1.9 l/min



PCN-10
Flow: 0.23 m³/hr;
3.8 l/min



PCN-20
Flow: 0.46 m³/hr;
7.6 l/min

5-CST-B BUBBLER NOZZLE PERFORMANCE DATA

Pressure	Radius		Flow	
	bar	kPa	m	m ³ /hr l/min
 1.0	100	1.5	0.07	1.1
1.5	150	1.5	0.07	1.2
2.0	200	1.5	0.09	1.4
2.1	210	1.5	0.09	1.5
2.5	250	1.5	0.10	1.6

5-CST-B



DUAL-STREAM BUBBLER NOZZLE



5-CST-B

BUBBLERS

Ensure consistent flow regardless of pressure with above-ground, pressure-compensating Bubblers.

KEY BENEFITS

- Pressure-compensating for constant water flow at any pressure
- Designed for deep watering of planted areas
- ½" threaded inlet for easy installation on a ½" riser

OPERATING SPECIFICATIONS

- *SASO Quality Mark Certified
- Warranty period: 2 years

PCB PERFORMANCE DATA

	Model	Flow		Pattern Type
		m ³ /hr	l/min	
	25	0.06	0.9	Trickle
	50	0.11	1.9	Trickle
	10	0.23	3.8	Umbrella
	20	0.45	7.6	Umbrella

Notes:

Typical spacing 0.6 to 1.2 m. Flows shown for pressures between 1.0 and 4.8 bar; 100 and 480 kPa.

PCB



PRESSURE-COMPENSATING BUBBLERS



PCB*



PCB-R*

AFB PERFORMANCE DATA

	Model	Flow		Pattern Type
		m ³ /hr	l/min	
	AFB	< 0.45	< 7.6	Trickle/ Umbrella

AFB



ADJUSTABLE FLOOD BUBBLER



AFB

HUNTER PRO-SPRAY™ SPRINKLER BODIES AND NOZZLES

The most trusted spray solutions in the industry

Choose the right spray system from the start! The Hunter Pro-Spray Sprinkler Body lets you simplify inventory, save time, speed service calls, and ensure years of beautiful, healthy landscapes for your customers.

With a reputation as the industry's strongest, most versatile spray body, it's also compatible with a wide array of high-performing nozzles for maximum performance and even watering in all types of applications.



Ensure leak-free performance with a co-moulded wiper seal

HUNTER PRO-SPRAY

Protect against field damage with thick, coined edges

Make retrofitting a breeze with a durable, interchangeable cap



Stop water waste in the event of a missing nozzle with optional FloGuard™ Technology

Simplify inventory management with the same body across all models

Optimise field performance with a pressure-regulated riser

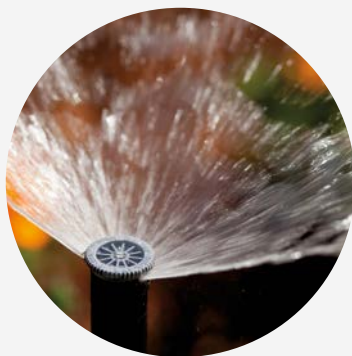

HUNTER ADJUSTABLE NOZZLES

These proven nozzles fight the effects of wind with large droplets, distribute water evenly with a smooth spray pattern, and minimise overspray with crisp edges.



Stop runoff with a field- or factory-installed check valve



A close-up photograph of a Hunter irrigation manifold box. The box is filled with dark gravel and contains several white PVC valves. One valve is prominently featured in the center, with a black top and a red wire connected to it. The top of the valve has a circular dial with 'OFF' and '1/4 TURN' markings. The word 'VALVES' is overlaid in large, white, bold letters across the center of the image.

VALVES



Look for this icon. All Hunter valves are 100% water-tested to ensure reliable operation once installed.

VALVE COMPARISON CHART

QUICK SPECS		1" PGV & JAR-TOP	PGV	ICV	ICV FILTER SENTRY	IBV FILTER SENTRY
SIZE		1" BSP (25 mm)	1½", 2" BSP (40, 50 mm)	1", 1½", 2", 3" BSP (25, 40, 50, 80 mm)	1", 1½", 2", 3" BSP (25, 40, 50, 80 mm)	1", 1½", 2", 3" BSP (25, 40, 50, 80 mm)
FLOW	(m³/hr)	0.05-9	0.05-34	0.05-68	0.05-68	0.05-68
	(l/min)	0.7-150	0.7-570	0.4-1135	0.4-1135	0.4-1135

FEATURES

CAPTIVE BONNET BOLTS		●	●	●	●	
EPDM DIAPHRAGM AND SEAT				Standard	Standard	Standard
WARRANTY		2 Years	2 Years	5 Years	5 Years	5 Years

ADVANCED FEATURES

FLOW CONTROL	Optional	●	●	●	●	
FILTER SENTRY™ MECHANISM				User-Installed	Factory-Installed	Factory-Installed
ACCU SYNC™ CAPABLE		●	●	●	●	●
RECLAIMED WATER ID HANDLE	User-Installed	User-Installed	User-Installed	User-Installed	User-Installed	User-Installed
RECLAIMED WATER ID TAG				User-Installed	User-Installed	User-Installed

APPLICATIONS

RESIDENTIAL	●	●	●			
COMMERCIAL		●	●		●	●
POTABLE WATER	●	●	●		●	●
RECLAIMED WATER			●		●	●
SECONDARY WATER					●	●
PRESSURE REGULATION	●	●	●		●	●
HIGH-PRESSURE SYSTEMS			●		●	●
LOW-PRESSURE SYSTEMS	●	●	●		●	●
HIGH-TEMPERATURE LOCATIONS			●		●	●
USE AS MASTER VALVE		●	●		●	●

Advanced Features



ACCU SYNC PRESSURE REGULATORS

Available on:
PGV, ICV, IBV

Avoid sprinkler over-pressure conditions and gain significant water savings with Accu Sync Pressure Regulators. This option is available in adjustable or fixed pressure models.



FILTER SENTRY MECHANISM

For use with:
ICV, IBV

The Filter Sentry Mechanism scours the filter clean twice during each valve cycle. Since it is attached to the diaphragm, the Filter Sentry feature can be easily added after a valve has been installed.



1½" (40 MM) AND 2" (50 MM) PGV

These reliable valves provide long-lasting performance for larger systems.

KEY BENEFITS

- External/internal manual bleed allows for quick and easy activation at the valve
- Double-beaded diaphragm seal design ensures leak-free performance
- Captive bonnet screws eliminate the possibility of lost parts during disassembly
- Flow control maximises efficiency and prolongs the life of the system
- Triple-tool bonnet screws are compatible with standard or Phillips screwdrivers as well as a nut driver
- Each valve available with globe or angle configuration for convenient placement
- Encapsulated solenoid with captive plunger used on every Hunter valve provides hassle-free service

USER-INSTALLED OPTIONS

- Accu Sync™ Pressure Regulator at the valve*
- DC-Latching Solenoid for battery-operated controllers (P/N 458200)
- Reclaimed flow control handle (P/N 607105)

FACTORY-INSTALLED OPTIONS

- DC: DC-Latching Solenoid for battery-operated controllers; **see page 103**
- LS: Valve without solenoid

OPERATING SPECIFICATIONS

- Flow:
 - PGV-151: 5 to 27 m³/hr; 75 to 450 l/min
 - PGV-201: 5 to 34 m³/hr; 75 to 570 l/min
- Recommended pressure range: 1.5 to 10 bar; 150 to 1000 kPa
- Temperature rating: 66°C
- Warranty period: 2 years

* Accu Sync product information on **page 102**

SOLENOID SPECIFICATIONS

- 24 VAC solenoid
 - 350 mA inrush, 190 mA holding, 60 Hz
 - 370 mA inrush, 210 mA holding, 50 Hz



PGV-151 VALVE
Inlet diameter: 1½" (40 mm)
Height: 19 cm
Length: 15 cm
Width: 11 cm



PGV-201 VALVE
Inlet diameter: 2" (50 mm)
Height: 20 cm
Length: 17 cm
Width: 13 cm

PGV Installed



PGV PRESSURE LOSS IN kPa

Flow l/min	1½" (40 mm) Globe	1½" (40 mm) Angle	2" (50 mm) Globe	2" (50 mm) Angle
75	20	22	4	9
95	20	21	5.5	9
115	21	21	7.5	9.5
135	22	21	9	10
150	25	23	12	11
200	27	24	14	12
325	47	41	26	19
400	65	59	33	24
500	96	92	43	32
625			56	45
775			74	64

PGV PRESSURE LOSS IN BAR

Flow m ³ /hr	1½" (40 mm) Globe	1½" (40 mm) Angle	2" (50 mm) Globe	2" (50 mm) Angle
4.5	0.2	0.2	0.1	0.1
5.5	0.2	0.2	0.1	0.1
6.5	0.2	0.2	0.1	0.1
8.0	0.2	0.2	0.1	0.1
9.0	0.2	0.2	0.1	0.1
11.0	0.3	0.2	0.1	0.1
13.5	0.3	0.3	0.1	0.1
18.0	0.4	0.4	0.2	0.1
22.5	0.6	0.5	0.3	0.2
27.0	0.8	0.8	0.4	0.3
30.5			0.6	0.5
34.0			0.7	0.6

PGV 1½" & 2" - SPECIFICATION BUILDER: ORDER 1 + 2 + 3 + 4

1 Model	2 Standard Features	3 Feature Options	4 User-Installed Options
<p>PGV-151-B = 1½" (40 mm) BSP</p> <p>PGV-201-B = 2" (50 mm) BSP</p>	Globe / angle valve with flow control	<p>(blank) = No option</p> <p>DC = DC-Latching Solenoid for battery-operated controllers</p> <p>LS = Less solenoid</p>	<p>AS-ADJ = Adjustable Accu Sync Pressure Regulator</p> <p>458200 = DC-Latching Solenoid for battery-operated controllers</p> <p>607105 = Reclaimed flow control handle</p> <p>LIT-700 = Reclaimed ID tag</p>

Examples:

PGV-201-B-AS-ADJ = 2" (50 mm) BSP PGV globe/angle valve with flow control, user-installed Accu Sync Pressure Regulator

1" (25 MM) PGV AND PGV JAR-TOP



These versatile and robust valves offer simple serviceability.

KEY BENEFITS

- External/internal manual bleed allows for quick and easy activation at the valve
- Double-beaded diaphragm seal design ensures leak-free performance
- Captive bonnet screws eliminate the possibility of lost parts during disassembly
- Triple-tool bonnet screws are compatible with standard or Phillips screwdrivers as well as a nut driver
- Jar-top models provide easy access without tools
- Encapsulated solenoid with captive plunger used on every Hunter valve provides hassle-free service
- Flow control maximises efficiency and prolongs the life of the system

USER-INSTALLED OPTIONS

- Accu Sync™ Pressure Regulator at the valve*
- DC-Latching Solenoid for battery-operated controllers (P/N 458200)

FACTORY-INSTALLED OPTIONS

- LS: Valve without solenoid
- DC: DC-Latching Solenoid for battery-operated controllers; [see page 103](#)

OPERATING SPECIFICATIONS

- Flow: 0.05 to 9 m³/hr; 0.7 to 150 l/min
- Recommended pressure range: 1.5 to 10 bar; 150 to 1,000 kPa
- Temperature rating: 66°C
- Warranty period: 2 years

SOLENOID SPECIFICATIONS

- 24 VAC solenoid
 - 350 mA inrush, 190 mA holding, 60 Hz
 - 370 mA inrush, 210 mA holding, 50 Hz

* Accu Sync product information on [page 102](#)



PGV-100G VALVE
Inlet diameter: 1" (25 mm)
Height: 13 cm
Length: 11 cm
Width: 6 cm



PGV-101G VALVE
Inlet diameter: 1" (25 mm)
Height: 13 cm
Length: 11 cm
Width: 6 cm



PGV-100JT-G VALVE
Inlet diameter: 1" (25 mm)
Height: 14 cm
Length: 11 cm
Width: 8 cm



PGV-101JT-G VALVE
Inlet diameter: 1" (25 mm)
Height: 14 cm
Length: 11 cm
Width: 8 cm

Double-Beaded Diaphragm



AC Solenoid
(P/N 606800)
Two red wires

PGV - SPECIFICATION BUILDER : ORDER 1 + 2 + 3 + 4 + 5									
1	Model	2	Standard Features	3	Feature Options	4	Options	5	User-Installed Options
	PGV-100 = 1" (25 mm)		Globe valve, without flow control, threaded inlet/outlet		G-B = BSP female threaded inlet/outlet		DC = DC-Latching Solenoid for battery-operated controllers		AS-ADJ = Accu Sync adjustable
	PGV-101 = 1" (25 mm)		Globe valve, with flow control, threaded inlet/outlet		MM-B = BSP male threaded inlet/outlet		LS = Less solenoid		458200 = DC-Latching Solenoid for battery-operated controllers
									269205 = Reclaimed flow control handle
									LIT-700 = Reclaimed ID tag

Example:

PGV-101-G-B-DC = 1" (25 mm) PGV globe valve, with flow control, with female BSP inlet and outlet, with DC-Latching Solenoid

PGV JAR-TOP - SPECIFICATION BUILDER : ORDER 1 + 2 + 3 + 4 + 5									
1	Model	2	Standard Features	3	Feature Options	4	Options	5	User-Installed Options
	PGV-100-JT = 1" (25 mm)		Globe valve, jar-top bonnet, without flow control, threaded inlet/outlet		G-B = BSP female threaded inlet/outlet		DC = DC-Latching Solenoid for battery-operated controllers		AS-ADJ = Accu Sync adjustable
	PGV-101-JT = 1" (25 mm)		Globe valve, jar-top bonnet, with flow control, threaded inlet/outlet		MM-B = BSP male threaded inlet/outlet		LS = Less solenoid		458200 = DC-Latching Solenoid for battery-operated controllers
									269205 = Reclaimed flow control handle
									LIT-700 = Reclaimed ID tag

Example:

PGV-101-JT-MM-B-DC = 1" (25 mm) PGV globe valve, with jar-top bonnet, with flow control, with male BSP inlet and outlet, with DC-Latching Solenoid

1" (25 MM) PGV VALVE	
Flow m ³ /hr	Pressure Loss bar
0.3	0.08
1.0	0.11
2.5	0.13
3.5	0.16
4.5	0.23
5.5	0.43
6.5	0.62
8.0	1.10
9.0	1.48

1" (25 MM) PGV VALVE	
Flow l/min	Pressure Loss kPa
4	8
20	11
40	13
55	16
75	23
95	43
115	62
135	110
150	148

PGV-100G Valve Installed



Captive Bonnet Bolts



This valve is the perfect choice for high-pressure systems and dirty water conditions.

KEY BENEFITS

- Optional Filter Sentry™ Mechanism scours the filter screen in dirty water conditions
- External/internal manual bleed allows for quick and easy activation at the valve
- Glass-filled nylon construction provides high pressure rating and reliability
- Double-beaded diaphragm seal design ensures leak-free performance
- Fabric-reinforced EPDM diaphragm and seat ensure greater performance in all water conditions
- Captive bonnet screws eliminate the possibility of lost parts during disassembly
- Triple-tool bonnet screws are compatible with standard or Phillips screwdrivers as well as a nut driver
- Encapsulated solenoid with captive plunger used on every Hunter valve provides hassle-free service
- Flow control maximises efficiency and prolongs the life of the system

USER-INSTALLED OPTIONS

- Accu Sync™ Pressure Regulator at the valve*
- DC-Latching Solenoid for battery-operated controllers (P/N 458200)
- Filter Sentry Mechanism easily added to an installed valve

FACTORY-INSTALLED OPTIONS

- LS: Valve without solenoid
- DC: DC-Latching Solenoid for battery-operated controllers; **see page 103**
- FS: Filter Sentry
- FS-R: Reclaimed option with Filter Sentry Mechanism, purple control knob, and purple, chlorine-resistant diaphragm (available only on 40 mm and 50 mm models)

OPERATING SPECIFICATIONS

- Flow:
 - ICV-101G: 0.03 to 9 m³/hr; 0.4 to 150 l/min
 - ICV-151G: 0.03 to 34 m³/hr; 0.4 to 568 l/min
 - ICV-201G: 0.03 to 45 m³/hr; 0.4 to 757 l/min
 - ICV-301: 0.03 to 68 m³/hr; 0.4 to 1,135 l/min
- Recommended pressure range: 1.5 to 15.0 bar; 150 to 1,500 kPa
- Temperature rating: 66°C
- SASO Quality Mark Certified
- Warranty period: 5 years

SOLENOID SPECIFICATIONS

- 24 VAC solenoid
 - 350 mA inrush, 190 mA holding, 60 Hz
 - 370 mA inrush, 210 mA holding, 50 Hz

* Accu Sync product information on **page 102**



ICV-101G VALVE

Inlet diameter: 1" (25 mm)
Height: 14 cm
Length: 12 cm
Width: 10 cm



ICV-151G VALVE

Inlet diameter: 1½" (40 mm)
Height: 18 cm
Length: 17 cm
Width: 14 cm



ICV-201G VALVE

Inlet diameter: 2" (50 mm)
Height: 18 cm
Length: 17 cm
Width: 14 cm



ICV-301 VALVE

Inlet diameter: 3" (80 mm)
Height: 27 cm
Length: 22 cm
Width: 19 cm



ICV-R VALVE

Inlet diameter: 1½" (40 mm) and 2" (50 mm)
Height: 18 cm
Length: 17 cm
Width: 14 cm

Double-Beaded Chlorine-Resistant Diaphragm

Filter Sentry Mechanism



ICV 1", 1½", 2" AND 3" - SPECIFICATION BUILDER: ORDER 1 + 2 + 3 + 4

1 Model	2 Standard Features	3 Feature Options	4 User-Installed Options
ICV-101-G-B = 1" (25 mm) BSP	Globe valve with flow control	(blank) = No option FS = Filter Sentry Mechanism FS-R = Purple reclaimed Filter Sentry Mechanism and ID tag (available only on 40 mm and 50 mm models) DC = DC-Latching Solenoid for battery-operated controllers LS = Less solenoid	AS-ADJ = Adjustable Accu Sync Pressure Regulator 458200 = DC-Latching Solenoid for battery-operated controllers 607105 = Reclaimed flow control handle (25, 40, 50 mm only) LIT-700 = Reclaimed ID tag
ICV-151-G-B = 1½" (40 mm) BSP			
ICV-201-G-B = 2" (50 mm) BSP			
ICV-301-B = 3" (80 mm) BSP	Globe / angle valve with flow control		

Example:
ICV-201G-B-AS-ADJ = 2" (50 mm) BSP ICV globe valve with flow control, user-installed adjustable Accu Sync Pressure Regulator

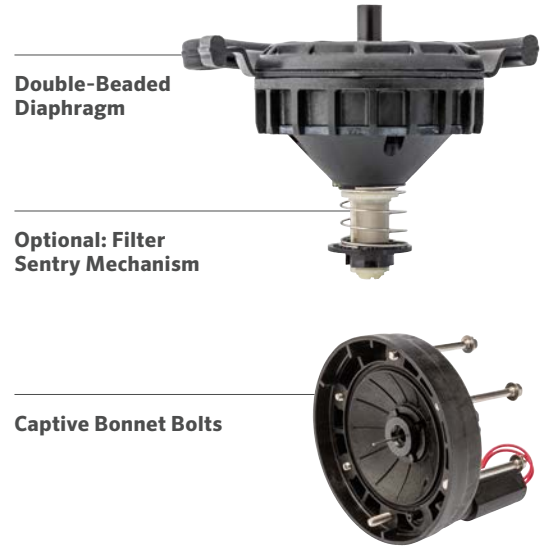

VALVES

ICV PRESSURE LOSS (AT OPTIMAL FLOWS) IN BAR

Flow m³/hr	1" (25 mm) Globe	1½" (40 mm) Globe	2" (50 mm) Globe	3" (80 mm) Globe	3" (80 mm) Angle
0.05	0.1				
0.1	0.1				
0.3	0.1				
1.0	0.2				
2.5	0.2				
3.5	0.2				
4.5	0.2	0.1			
7.0	0.4	0.1			
9.0	1.0	0.1	0.1		
11.0		0.2	0.1		
13.5		0.2	0.1		
17.0		0.3	0.1		
20.5		0.4	0.2		
23.0		0.5	0.3		
27.0		0.7	0.4		
30.5		0.9	0.5		
34.0		1.2	0.6	0.2	0.1
40.0			0.9	0.2	0.2
45.5			1.2	0.3	0.2
51.0				0.3	0.3
57.0				0.4	0.4
62.5				0.5	0.5
68.0				0.6	0.6

ICV PRESSURE LOSS (AT OPTIMAL FLOWS) IN kPa

Flow l/min	1" (25 mm) Globe	1½" (40 mm) Globe	2" (50 mm) Globe	3" (80 mm) Globe	3" (80 mm) Angle
1	14				
2	14				
4	14				
20	17				
40	20				
60	20				
75	20	9.6			
115	62	10			
150	139	12	5.0		
190		15	7.0		
225		18	9.3		
280		26	14		
340		37	20		
380		46	26		
450		65	36		
510		84	47		
565		104	57	16	12
660			79	22	17
750			103	29	23
850				38	30
950				47	38
1,050				58	47
1,135				69	56



AC Solenoid
 (P/N 606800)
 Two red wires

Built of solid brass, this valve can power through the fiercest irrigation conditions.

KEY BENEFITS

- Factory-installed Filter Sentry™ Mechanism scours the filter screen in dirty water conditions
- External/internal manual bleed allows for quick and easy activation at the valve
- Heavy-duty brass construction provides high pressure rating and reliability
- Double-beaded diaphragm seal design ensures leak-free performance
- Fabric-reinforced EPDM diaphragm and seat ensure greater performance in all water conditions
- Triple-tool bonnet screws are compatible with standard or Phillips screwdrivers as well as a nut driver
- Encapsulated solenoid with captive plunger used on every Hunter valve provides hassle-free service
- Flow control maximises efficiency and prolongs the life of the system

USER-INSTALLED OPTIONS

- Accu Sync™ Pressure Regulator at the valve*
- DC-Latching Solenoid for battery-operated controllers (P/N 458200)

FACTORY-INSTALLED OPTIONS

- DC: DC-Latching Solenoid for battery-operated controllers; see page 103

OPERATING SPECIFICATIONS

- Flow rate:
 - IBV-101G-FS: 0.03 to 9 m³/hr; 0.4 to 150 l/min
 - IBV-151G-FS: 0.03 to 34 m³/hr; 0.4 to 568 l/min
 - IBV-201G-FS: 0.03 to 45 m³/hr; 0.4 to 757 l/min
 - IBV-301G-FS: 0.03 to 68 m³/hr; 0.4 to 1,135 l/min
- Recommended pressure range: 1.5 to 15 bar; 150 to 1,500 kPa
- Temperature rating: 66°C
- Warranty period: 5 years

SOLENOID SPECIFICATIONS

- 24 VAC solenoid
 - 350 mA inrush, 190 mA holding, 60 Hz
 - 370 mA inrush, 210 mA holding, 50 Hz

* Accu Sync product information on page 102



IBV-101G-FS VALVE

Inlet diameter: 1" (25 mm)
Height: 14 cm
Length: 12 cm
Width: 8 cm



IBV-151G-FS VALVE

Inlet diameter: 1½" (40 mm)
Height: 17 cm
Length: 15 cm
Width: 15 cm

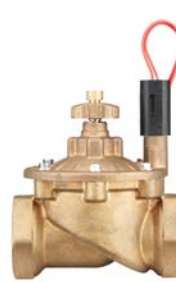

IBV-201G-FS VALVE

Inlet diameter: 2" (50 mm)
Height: 18 cm
Length: 15 cm
Width: 15 cm



IBV-301G-FS VALVE

Inlet diameter: 3" (80 mm)
Height: 23 cm
Length: 22 cm
Width: 18 cm

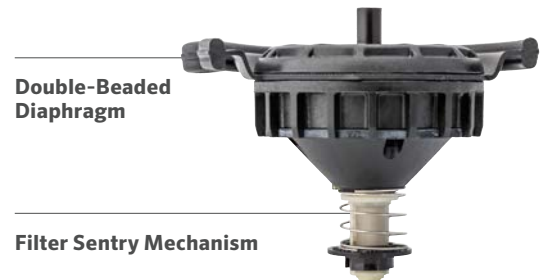

Double-Beaded Diaphragm

Filter Sentry Mechanism

IBV 1", 1½", 2" & 3" - SPECIFICATION BUILDER: ORDER 1 + 2 + 3 + 4

1	Model	2	Standard Features	3	Feature Options	4	User-Installed Options
	IBV-101G-B-FS = 1" (25 mm) BSP		Brass globe valve with flow control, Filter Sentry Mechanism		(blank) = No Option		AS-ADJ = Adjustable Accu Sync Pressure Regulator
	IBV-151G-B-FS = 1½" (40 mm) BSP				R = Purple reclaimed Filter Sentry Mechanism and ID tag (available only on 40 mm and 50 mm models)		458200 = DC-Latching Solenoid for battery-operated controllers
	IBV-201G-B-FS = 2" (50 mm) BSP				DC = DC-Latching Solenoid for battery-operated controllers		607105 = Reclaimed flow control handle
	IBV-301G-B-FS = 3" (80 mm) BSP				LS = Less solenoid		LIT-700 = Reclaimed ID tag

Double-Beaded Chlorine-Resistant Diaphragm

Filter Sentry Mechanism



VALVES

Example:

IBV-201G-B-FS-AS-ADJ = 2" (50 mm) BSP IBV brass globe valve with flow control, Filter Sentry mechanism, user-installed adjustable Accu Sync Pressure Regulator

IBV PRESSURE LOSS (AT OPTIMAL FLOWS) IN BAR

Flow m³/hr	1" (25 mm) Globe	1½" (40 mm) Globe	2" (50 mm) Globe	3" (80 mm) Globe
0.05	0.1			
0.1	0.1			
0.3	0.1			
1.0	0.2			
2.5	0.2			
3.5	0.2			
4.5	0.2	0.1		
7.0	0.4	0.1		
9.0	1.0	0.1	0.1	
11.0		0.2	0.1	
13.5		0.2	0.1	
17.0		0.3	0.2	
20.5		0.4	0.2	
23.0		0.5	0.3	
27.0		0.7	0.4	
30.5		0.9	0.5	
34.0			0.6	0.2
40.0				0.2
45.5				0.3
51.0				0.3
57.0				0.4
62.5				0.5
68.0				0.6

IBV PRESSURE LOSS (AT OPTIMAL FLOWS) IN kPa

Flow l/min	1" (25 mm) Globe	1½" (40 mm) Globe	2" (50 mm) Globe	3" (80 mm) Globe
0.1	14			
0.5	14			
4	14			
20	17			
40	20			
60	20			
75	20	9.6		
115	62	10		
150	139	12	5	
190		15	7	
225		18	9.3	
280		26	14	
340		37	20	
380		46	26	
450		65	36	
510		84	47	
565			57	16
660				22
750				29
850				38
950				47
1,050				58
1,135				69

QUICK COUPLERS

The sturdy red brass and stainless steel construction of Quick Couplers strengthens any project.

FEATURES

- 100% interchangeable with major brands
- Red brass and stainless steel construction
- Heavy-duty thermoplastic locking and non-locking covers
- Optional winged stabilisation and Acme key connection
- Stainless steel lug on 1" (25 mm) and 1¼" (32 mm) keys
- Spring-loaded covers with stainless steel springs for positive closing and protection of valve's sealing components
- Warranty period: 5 years



Quick Couplers

HQ QUICK COUPLER - SPECIFICATION BUILDER: ORDER 1 + 2 + 3

1 Model	2 Cover Options	3 Additional Options
HQ-3 = ¾" inlet, 1-piece body, 2 slots HQ-5 = 1" (25 mm) inlet, 1-piece body, 1 slot HQ-33D = ¾" inlet, 2-piece body, 2 slots HQ-44 = 1" (25 mm) inlet, 2-piece body, 1 slot or Acme	RC = Yellow rubber cover LRC = Yellow locking rubber cover <i>(Not available for HQ-3 body)</i>	(blank) = No option AW = Acme key with anti-rotation wings <i>(Only available for HQ-44 body)</i> BSP = BSP threads <i>(Only available for HQ-5 body)</i> R = Purple locking cover (reclaimed water ID; only available for LRC models)

Examples:

- HQ-3-RC = HQ-3 valve with rubber cover
- HQ-44-LRC = HQ-44 valve with locking rubber cover
- HQ-44-LRC-R = HQ-44 valve with locking rubber cover and purple locking cover
- HQ-44-LRC-AW-R = HQ valve, with locking rubber cover, Acme key socket, anti-rotation wings and purple locking cover
- HQ-5-LRC-BSP = HQ-5 valve with locking rubber cover and BSP threads



HQ-3-RC HQ-5-RC HK-33



HQ-33-DLRC-R HQ-44-LRC HK-44

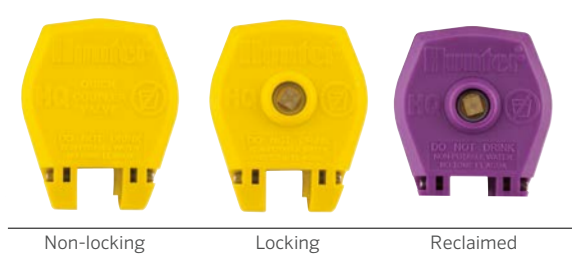

Non-locking Locking Reclaimed



HQ-44-RC-AW HK-44A



Key

Reclaimed Water Option

All locking models have an optional purple cover for sites using reclaimed water.

HK KEYS

Key Model	Compatible Valve	Compatible Swivel
HK-33 = ¾" valve, ¾" key inlet	HQ-3, HQ-33	HS-0
HK-44 = 1" (25 mm) valve, 1" (25 mm) key inlet	HQ-44	HS-1, HS-2, HS-1-B, HS-2-B
HK-44A = 1" (25 mm) valve, Acme key inlet	HQ-44-AW	HS-1, HS-2, HS-1-B, HS-2-B
HK-55 = 1" (25 mm) valve, 1¼" (32 mm) key inlet	HQ-5	HS-1, HS-2, HS-1-B, HS-2-B

HS HOSE SWIVELS

Hose Swivel	Compatible Key
HS-0 = ¾" inlet, ¾" hose outlet	HK-33
HS-1 = 1" (25 mm) inlet, ¾" hose outlet	HK-44, HK-44A, HK-55
HS-2 = 1" (25 mm) inlet, 1" (25 mm) hose outlet	HK-44, HK-44A, HK-55
HS-1-B = 1" (25 mm) inlet, ¾" (20 mm) BSP outlet	HK-44, HK-44A, HK-55
HS-2-B = 1" (25 mm) inlet, 1" (25 mm) BSP outlet	HK-44, HK-44A, HK-55

QUICK COUPLER, KEY, AND HOSE SWIVEL CHARTS

Model	Inlet Threads	Slots	Body	Colour*	Locking	Key	Swivels
HQ-3-RC	¾"	2	1-piece	Yellow	No	HK-33	HS-0
HQ-33-DRC	¾"	2	2-piece	Yellow	No	HK-33	HS-0
HQ-33-DLRC	¾"	2	2-piece	Yellow	Yes	HK-33	HS-0
HQ-44-RC	1" (25 mm) NPT	1	2-piece	Yellow	No	HK-44	HS-1 or HS-2
HQ-44-LRC	1" (25 mm) NPT	1	2-piece	Yellow	Yes	HK-44	HS-1 or HS-2
HQ-44-RC-AW	1" (25 mm) NPT	Acme	2-piece wing**	Yellow	No	HK-44A	HS-1 or HS-2
HQ-44-LRC-AW	1" (25 mm) NPT	Acme	2-piece wing**	Yellow	Yes	HK-44A	HS-1 or HS-2
HQ-5-RC	1" (25 mm) NPT	1	1-piece	Yellow	No	HK-55	HS-1 or HS-2
HQ-5-LRC	1" (25 mm) NPT	1	1-piece	Yellow	Yes	HK-55	HS-1 or HS-2
HQ-5-RC-BSP	1" (25 mm) BSP	1	1-piece	Yellow	Yes	HK-55	HS-1 or HS-2
HQ-5-LRC-BSP	1" (25 mm) BSP	1	1-piece	Yellow	Yes	HK-55	HS-1 or HS-2

Notes:

* All locking cover models are available with purple covers for reclaimed water applications

** Anti-rotation stabilisation wings

HQ PRESSURE LOSS IN BAR					HQ PRESSURE LOSS IN kPa				
Flow m ³ /hr	HQ-3	HQ-33	HQ-44	HQ-5	Flow l/min	HQ-3	HQ-33	HQ-44	HQ-5
1	0.06	0.07			18.9	5.5	6.9		
2.3	1.12	0.14			37.9	12.4	13.8		
3.4	0.28	0.30	0.15		56.8	28.3	29.6	15.2	
4.5	0.50	0.52	0.30	0.07	75.7	49.6	52.4	30.3	6.9
6.8			0.79	0.21	113.6			79.3	20.7
9.1				0.43	151.4				43.4
11.4				0.63	189.3				63.4
13.6				0.90	227.1				89.6
15.9				1.37	265.0				136.5

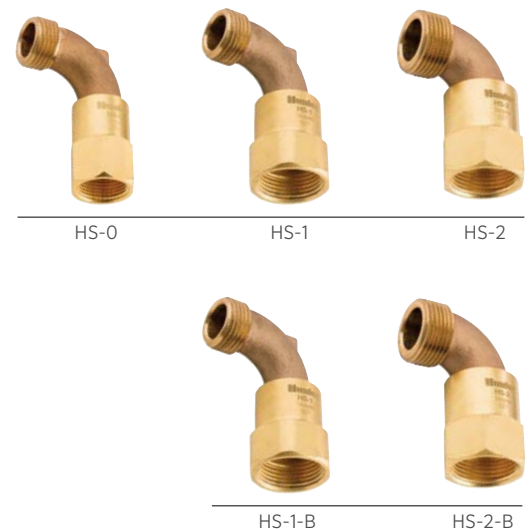

ACCU SYNC™ PRESSURE REGULATORS

Provides an easy solution to limit pressure for optimal performance.

OPERATING SPECIFICATIONS

- Regulation from 1.4 to 7.0 bar; 140 to 700 kPa
- Static pressure: 10 bar; 1,000 kPa
- Required dynamic pressure differential: 1.0 bar; 100 kPa
- Works with AC and DC-Latching Solenoids
- Works with any Hunter valve
- Warranty period: 2 years

ACCU SYNC PRESSURE REGULATOR RECOMMENDED FLOW RANGE

Valve	Flow	
	m ³ /hr	l/min
PGV-100/101	4.5 to 9.1	76 to 151
PGV-151	4.5 to 28	76 to 454
PGV-201	9.1 to 34	151 to 568
ICV-101	3.4 to 9.1	57 to 151
ICV-151	4.5 to 34	76 to 568
ICV-201	34 to 68	151 to 757
ICV-301	3.4 to 68	568 to 1,136
IBV-101	34 to 9.1	57 to 151
IBV-151	4.5 to 34	76 to 568
IBV-201	34 to 68	151 to 757
IBV-301	34 to 68	568 to 1,136

ACCU SYNC APPLICATIONS

- **Adjustable 1.4 to 7.0 bar** For full customisation, the adjustable Accu Sync can regulate pressure from 1.4 to 7.0 bar; 140 to 700 kPa

ACCU SYNC PRESSURE REGULATOR – SPECIFICATION BUILDER: ORDER 1 + 2

1 Model	2 Inlet/Outlet
ACCU SYNC	ADJ = Adjustable pressure regulator (1.4 to 7.0 bar)

Example:
ICV-201G-B-AS-ADJ = 2" (50 mm) BSP ICV globe valve with flow control, user-installed adjustable Accu Sync Pressure Regulator

ADJUSTABLE



ACCUSYNC-ADJ PRESSURE REGULATOR

Height with solenoid: 8 cm

ADAPTER



SOLENOID ADAPTER



Installation

Accu Sync shown installed on ICV Valve.

DC-LATCHING SOLENOID

Allows valve operation with battery-operated controllers.

KEY BENEFITS

- Compatible with all Hunter irrigation valves
- Compatible with NODE, NODE-BT, and XC Hybrid
- Captive plunger offers easy servicing of solenoid
- Manual quarter-turn on/off control

OPERATING SPECIFICATIONS

- Minimum opening/operating voltage: 6 VDC
- Maximum recommended voltage: 9 VDC
- Coil resistance: 4.8 ohms nominal
- Pulse width: 250 milliseconds
- Wire leads: 45 cm of 0.8 mm² black/red UL-approved wire

Note: See controller product pages for wiring distances



DC-Latching Solenoid

(P/N 458200)

One black (common) wire and one red (station) wire

AC SOLENOID

The standard solenoid for all electric controllers.

KEY BENEFITS

- Compatible with all Hunter irrigation valves
- Captive plunger offers easy servicing of solenoid
- Manual quarter-turn on/off control
- Wire leads: 45 cm of 0.8 mm² red UL-approved wire

OPERATING SPECIFICATIONS

- Minimum operating voltage: 20.5 VAC
- Maximum recommended voltage: 24 VAC
 - 350 mA inrush, 190 mA holding, 60 HZ
 - 370 mA inrush, 210 mA holding, 50 HZ
- Coil resistance: 23 to 28 ohms nominal



AC Solenoid

P/N 606800: Includes one red (common) and one red (station) wire



PRO-HC Wi-Fi

Hunter[®]

CONTROLLERS



CONTROLLER

SELECTION GUIDE

Platform

AC-Powered Controllers

STANDARD

Details on [page 108](#)

Button and dial-based controllers are standalone systems that offer water-saving features and convenient remote control operation for faster maintenance.

Eco Logic
Stations: 4, 6
[page 110](#)



X-Core™
Stations: 2, 4, 6, 8
[page 111](#)



HYDRAWISE™

Details on [page 112](#)

The Wi-Fi controller solution designed for contractors. The Hydrawise Irrigation Management Platform is simple to set up, easy to use, and packed with helpful remote irrigation management features. Built-in system monitoring and a suite of powerful tools make saving water and managing multiple sites easy.

HC
Stations: 6, 12
[page 112](#)



X2™
Stations: 4, 6, 8, 14
[page 117](#)



X2 with WAND
Stations: 4, 6, 8, 14
[page 118](#)



Pro-HC
Stations: 6, 12, 24
[page 119](#)



HPC
Stations: 4 to 32
[page 120](#)



HCC
Stations: 8 to 54
[page 121](#)



CENTRALUS™

Details on [page 122](#)

Add cloud-based control and monitoring for Pro-C, ICC2, and ACC2 Controllers with the mobile-friendly Centralus Irrigation Management Platform.



Pro-C™
Stations: 4 to 32
[page 130](#)



ICC2
Stations: 8 to 54
[page 128](#)



ACC2
Stations: 12 to 54 conventional, 1 to 225 with two-wire
[page 126](#)



Use this guide to quickly compare Hunter controller power needs, station counts, and software platforms to ensure you choose the best controller for every installation.

Platform

Battery-Operated Controllers

INDEPENDENT

Details on [page 133](#)

Battery-operated controllers allow automatic irrigation for power-restricted valve locations and areas where hardscape blocks the ability to run wire affordably.

NODE
Stations: 1, 2, 4, 6
page 135



XC Hybrid
Stations: 6, 12
page 137



BLUETOOTH®

Details on [page 133](#)

Bluetooth-enabled, battery-operated controllers have all the benefits of independent battery controllers with convenient, on-site wireless control from a smartphone.

BTT
Zones: 1, 2
page 134



NODE-BT
Stations: 1, 2, 4
page 136



With the two-wire option, you can easily expand the system as needed after installation.

STANDARD CONTROLLERS





Standard controllers are self-contained irrigation systems designed for quick installation and programming. Perfect for entry-level residential projects, these simple and affordable options provide standard irrigation capabilities for small landscapes.

STANDARD CONTROLLER COMPARISON CHART

CONTROLLER MODELS	MAXIMUM STATIONS	SENSOR INPUTS	SMART ADJUSTMENT	REMOTE CONTROL	WEB ACCESS
ECO LOGIC	6	1	N/A	N/A	N/A
X-CORE™	8	1	Solar Sync™	ROAM, ROAM XL	N/A

ECO LOGIC

The reliable Eco Logic Controller is the first choice for small residential areas and has the option for water-saving accessories.

KEY BENEFITS

- Number of stations:
 - 4 or 6 (fixed models)
- 2 automatic programs with 4 start times each, with up to 4-hour run times per station
- QuickCheck™ Technology provides simple diagnostics of faulty field wiring
- Suspend irrigation up to 7 days during the off-season
- Short-circuit protection detects wiring faults and skips the station without system damage
- Seasonal adjustment for quicker schedule adjustments without changing run times

OPERATING SPECIFICATIONS

- Transformer input: 230 VAC
- Transformer output (24 VAC): 0.625 A
- Station output (24 VAC): 0.56 A
- P/MV output (24 VAC): 0.28 A
- Sensor inputs: 1
- Approvals: CE, UKCA, cUL
- Warranty period: 2 years

ECO LOGIC	
Model	Description
ELC-401i-E	4-station indoor controller, 230 VAC wall adapter
ELC-601i-E	6-station indoor controller, 230 VAC wall adapter



Plastic Indoor
 Height: 12.6 cm
 Width: 12.6 cm
 Length: 3.2 cm

Compatible with:

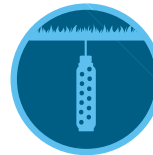

**Soil-Clik™
 Sensor**
 Page 157



**Rain-Clik™
 Sensor**
 Page 154

X-CORE™

Perfect for tract homes and entry-level residential systems, this simple and intuitive controller provides basic irrigation capabilities with convenient add-on options for smart watering adjustments and remote operation.

KEY BENEFITS

- Number of stations:
 - 2, 4, 6, or 8 (fixed models)
- Separate indoor and outdoor models for a variety of installation environments
- 3 automatic programs with 4 start times per program, and up to 4-hour run times per station
- Add a Solar Sync™ Sensor to save water based on local weather conditions
- QuickCheck™ Technology provides simple diagnostics of faulty field wiring
- Hide Programs setting shows 1 program and 1 start time for simplification
- Short-circuit protection detects wiring faults and skips the station without system damage
- Easy Retrieve™ Memory backs up the full irrigation schedule
- Delay Between Stations accommodates for slow-closing valves or pump recharge
- Cycle and Soak prevents water waste and runoff in areas with elevation changes or tight soils
- Seasonal adjustment for quicker schedule adjustments without changing run times

OPERATING SPECIFICATIONS

- Transformer input: 120 VAC or 230 VAC
- Transformer output (24 VAC): 1 A
- Station output (24 VAC): 0.56 A
- P/MV output (24 VAC): 0.28 A
- Sensor inputs: 1
- Approvals: Plastic IP54 (outdoor), UL, cUL, FCC, CE, UKCA, RCM, ISED
- Warranty period: 2 years

X-CORE - SPECIFICATION BUILDER: ORDER 1 + 2 + 3 + 4

1	Model	2	Transformer	3	Indoor/Outdoor	4	Plug
	XC-2 = 2-station (indoor only)		00 = 120 VAC		(blank) = Outdoor model		(blank) = American plug
	XC-4 = 4-station		01 = 230 VAC		i = Indoor model		E = European connections, no plug
	XC-6 = 6-station						A = Australian plug
	XC-8 = 8-station						

Examples:

XC-801i-E = 8-station controller, 230 VAC European wall adapter, indoor

XC-801-A = 8-station controller, 230 VAC internal transformer, outdoor with Australian plug



Plastic Indoor

Height: 16.5 cm
Width: 14.6 cm
Depth: 5 cm



Plastic Outdoor

Height: 22 cm
Width: 17.8 cm
Depth: 9.5 cm

Compatible with:



**Solar Sync
Sensor**
Page 156



ROAM Remote
Page 146
ROAM XL Remote
Page 147

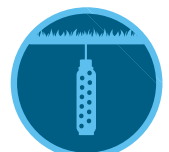

**Soil-Clik
Sensor**
Page 157



Smart WaterMark

Recognised as a responsible water-saving tool when used with a Solar Sync Sensor



HYDRAWISE™ CONTROLLERS



A healthy, beautiful garden needs just the right amount of water to thrive. The Hydrawise™ Irrigation Management Platform automatically adjusts watering based on your local weather. Choose from a complete lineup of Hydrawise-enabled controllers to maximise water and money savings in any setting.

HYDRAWISE CONTROLLER COMPARISON CHART

CONTROLLER MODELS	MAXIMUM STATIONS	SENSOR INPUTS	TWO-WIRE	REMOTE CONTROL	WEB ACCESS	FLOW
HC	12	2	N/A	Hydrawise App	Hydrawise: Wi-Fi	HC Flow Meter (wired or wireless)
X2™	14	1	N/A	ROAM, ROAM XL, Hydrawise App	Hydrawise: Wi-Fi (WAND Module)	N/A
X2 with WAND	14	1	N/A	ROAM, ROAM XL, Hydrawise App	Hydrawise: Wi-Fi	N/A
PRO-HC	24	2	N/A	Hydrawise App	Hydrawise: Wi-Fi	HC Flow Meter (wired or wireless)
HPC	32	2	EZDS	ROAM, ROAM XL, Hydrawise App	Hydrawise: Wi-Fi	HC Flow Meter (wired or wireless)
HCC	54	2	EZDS	ROAM, ROAM XL, Hydrawise App	Hydrawise: Wi-Fi	HC Flow Meter (wired or wireless)

HYDRAWISE™ SOFTWARE

As the industry's best Wi-Fi control solution, the Hydrowise Irrigation Management Platform allows for professional multi-site management and provides a range of helpful water-saving features for end users.



Save Water

PREDICTIVE WATERING™ TECHNOLOGY

Predictive Watering Technology uses past, current, and forecast weather data sourced from the internet to automatically adjust to local, real-time conditions and provide homeowners and end users with tremendous water savings.

VIRTUAL SOLAR SYNC™ SENSOR

Virtual Solar Sync uses daily ET measurements from your selected weather stations to supplement the Predictive Watering adjustments on your controller, working to save even more water.



Protect the Landscape

SYSTEM MONITORING

Flow rate and valve monitoring alert you in the event of a problem, so you can quickly prevent landscape degradation before significant damage occurs.

WEATHER MONITORING

Web-based climate monitoring automatically adjusts irrigation systems to local weather conditions, ensuring plants remain healthy — rain or shine.



Save Time and Labour

REMOTE MANAGEMENT

Make changes to a program and know the status of the controller and the irrigation plan without a site visit.

STORE CUSTOMER PLANS AND DESIGNS

Attach irrigation system layouts to your customers' controllers for quick reference in the field. Never forget the location of the pipes or valve boxes again.

ON-SITE REMOTE

Turn your smartphone into a remote control to make changes and check the irrigation system without visiting the controller.

All trademarks are property of their respective owners.



Build a Stronger Business

BUILD A STRONGER BUSINESS

Add services, grow revenue, increase customer satisfaction, and rest assured that Hydrowise has your back as you expand your business.

BUSINESS BRANDING

Gain instant recognition from your customers by including your business logo and details in your Hydrowise account.

MULTI-SITE MANAGER

Manage customers or multiple sites with our unique business tools.

- Summary of all controllers
- List view of customers/sites
- Search for customers and controllers
- View all controller events and logs
- View all controller alerts
- Branded automatic email reporting to customers
- Global control settings
 - Alerts
 - Watering Schedules
 - Start Times
 - Watering Triggers
- Quick select controllers
- Generate job sheets
- Manage subcontractors or regions

BUSINESS ACCOUNT

Manage staff access with different levels of permission. Remove or add staff easily and quickly. Add and store files, irrigation plans, layouts, or other documents for access by your staff.

MESSAGING

Receive messages from and send messages to customers and staff through the Hydrowise App.



Manage from Anywhere

GLOBAL APP AND WEB ACCESS

With Hydrowise, everything you need is in the palm of your hand. Remote access allows you to view, manage, and monitor irrigation controllers from your smartphone, tablet, or computer at your convenience.

SMART-HOME COMPATIBILITY

Hydrowise integrates seamlessly with Amazon Alexa™, Control4®, and HomeSeer™.

What's New with Hydrawise

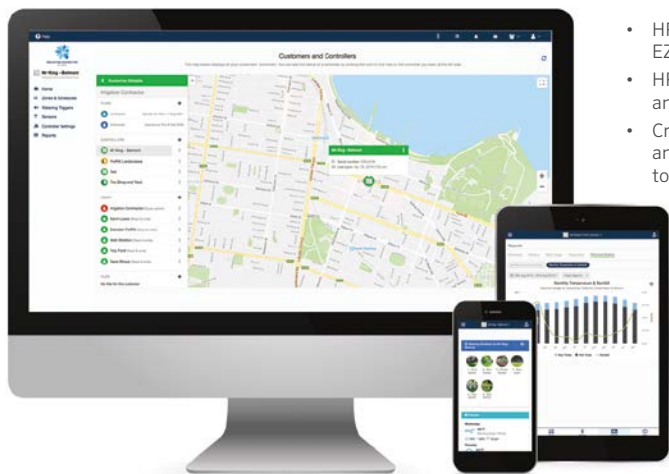

- HPC Controller now compatible with the EZ Decoder System up to 32 stations
- HPC Controller now has 2 sensor ports for any Klik sensor and HC Flow Meter
- Create custom reports for water savings and forecasts; automatically email them to your customers
- WAND Module for X2™ Controllers provides super-fast Bluetooth remote, Wi-Fi setup, and a convenient copy-paste function
- Controller touchscreen enhancements



Access to Hydrawise Software is free for all users worldwide.
To learn more, visit hydrawise.com.

Smart WaterMark
Recognised as a responsible water-saving tool



HC Controller
6- and 12-station count



X2 Controller with WAND Module
4-, 6-, 8-, and 14-station count



Pro-HC Controller
6-, 12-, and 24-station count



HPC Controller
4- to 32-station count, EZDS two-wire option



HCC Controller
8- to 54-station count, EZDS two-wire option



HC Flow Meter
Add an optional flow meter to receive flow alerts and monitor water consumption
Not available for X2 Controller

HC

The cost-effective solution for residential projects, the HC Controller provides smart water savings and remote irrigation management capabilities.

KEY BENEFITS

- Number of stations:
 - 6 or 12 (fixed models)
- Standard programming option allows for 6 independent irrigation programs and 6 start times per program
- Advanced programming option provides station-based programming with up to 6 total start times available
- 2 sensor inputs available for use with any Clik Sensors and HC Flow Meter
- Station outputs can also be used to activate a pump start relay or master valve
- Wi-Fi enabled for quick connection to Hydrawise Software
- 7 cm full-colour touchscreen display for simple programming at the control panel
- Built-in milliamp sensor for wire fault detection and alerts (12-zone models)

OPERATING SPECIFICATIONS

- Transformer input: 230 VAC
- Transformer output (24 VAC): 1 A
- Station output (24 VAC): 0.56 A
- P/MV output (24 VAC): 0.28 A
- 2.4 GHz (only) Wi-Fi router compatible, 802.11 b/g/n 20 MHz
- Supported security protocols: WPA/WPA2 Personal (only), TLS, SSL
- Approvals: UL, cUL, FCC, CE, UKCA, RCM, ISED
- Warranty period: 2 years

USER-INSTALLED OPTIONS

- Wireless HC Flow Meter option permits wireless flow monitoring for Hydrawise-enabled systems

Try Hydrawise Software today at hydrawise.com.



HC
(plastic indoor)
Height: 15.2 cm
Width: 17.8 cm
Depth: 3.3 cm

Compatible with:

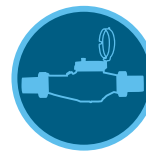

HC Flow Meter
Page 158

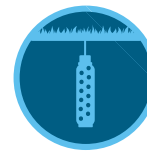

Soil-Clik Sensor
Page 157



Rain-Clik Sensor
Page 154



Smart WaterMark
Recognised as a responsible water-saving tool

HC	
Model	Description
HC-601i-E	Fixed 6-station, plastic indoor wall mount, 230 VAC European wall adapter
HC-1201i-E	Fixed 12-station, plastic indoor wall mount, 230 VAC European wall adapter

X2™

This online-capable controller offers Rapid Programming™ Technology and advanced water-saving features.

KEY BENEFITS

- Number of stations:
 - 4, 6, 8, or 14 (fixed models)
- Wi-Fi capable controller automatically managed by Hydrowise™ Software
- Backlit display provides optimal visibility in any light
- 3 flexible programs with 4 start times each and up to 6-hour run times
- QuickCheck™ Technology provides simple diagnostics of faulty field wiring
- Hide Programs option shows one program and one start time for simplification
- Suspend irrigation for up to 99 days during the off-season
- Short-circuit protection detects wiring faults and skips the station without system damage
- Easy Retrieve™ Memory backs up the full irrigation schedule
- Delay Between Stations for slow-closing valves or pump recharge
- Cycle and Soak prevents water waste and runoff in areas with elevation changes or tight soils
- Seasonal adjustment for quicker schedule updates without changing run times

OPERATING SPECIFICATIONS

- Transformer input: 120 VAC or 230 VAC
- Transformer output (24 VAC): 1 A
- Station output (24 VAC): 0.56 A
- P/MV output (24 VAC): 0.28 A
- Sensor inputs: 1
- Approvals (controller): Plastic IP55 (outdoor), UL, cUL, FCC, CE, UKCA, RCM, ISED
- Warranty period: 2 years



X2

Height: 23 cm
Width: 19 cm
Depth: 10 cm

Compatible with:



Hydrowise Software
Page 114



ROAM Remote
Page 146
ROAM XL Remote
Page 147



Rain-Clik™ Sensor
Page 154

X2 - SPECIFICATION BUILDER: ORDER 1 + 2 + 3					
1	Model	2	Transformer	3	Plug
	X2-4 = 4-station		00 = 120 VAC		(blank) = U.S. plug
	X2-6 = 6-station		01 = 230 VAC		E = European connections, no plug
	X2-8 = 8-station				A = Australian plug
	X2-14 = 14-station				

Examples:

- X2-1401-E = 14-station controller, 230 VAC internal transformer with no plug
- X2-1401-A = 14-station controller, 230 VAC internal transformer with Australian plug



Smart WaterMark

Recognised as a responsible water-saving tool when used with the WAND Module

The Bluetooth® word mark and logos are registered trademarks owned by Bluetooth SIG Inc., and any use of such marks by Hunter Industries is under licence. Amazon Alexa is a trademark of Amazon.com Inc. or its affiliates. Control4 is a registered trademark of Control4 Corporation in the United States and/or other countries. HomeSeer is a trademark of HomeSeer Technologies LLC.

WAND FOR X2™

This Wi-Fi upgrade option equips X2 Controllers with remote management capabilities from anywhere with an internet connection.

Try Hydrawise Software today at hydrawise.com.

KEY BENEFITS

- Simple Wi-Fi plug-in enables remote irrigation management with any X2 Controller
- WAND Technology provides easy online irrigation management with controller status and faulty wiring alerts
- Standard programming allows for 3 independent programs featuring 6 start times each and 24-hour maximum run times
- Rapid Programming™ Technology lets you send preprogrammed schedules to any X2 Controller in seconds, so you get jobs done quicker
- Predictive Watering™ Technology provides precise weather adjustments for maximum water savings
- Compatibility with Amazon Alexa™, Control4®, and HomeSeer™ home automation technology enables simple, centralised voice control of the irrigation system
- Bluetooth Wi-Fi setup or WPS push-button connection makes it easy to connect to a wireless network
- WAND Module sold separately from X2 Controller

OPERATING SPECIFICATIONS

- Flexible setup options: Bluetooth® Wi-Fi tether, Wi-Fi direct, or WPS push-button connection
- Bluetooth 5.0
- 2.4 GHz (only) Wi-Fi router compatible, 802.11 b/g/n 20 MHz
- Supported security protocols: WPA/WPA2 Personal (only), TLS
- Approvals: UL, cUL, FCC, CE, UKCA, RCM, ISED
- Warranty period: 2 years



WAND Module with Bluetooth and Wi-Fi Capability

Height: 2 cm
Width: 5 cm
Depth: 5 cm



WAND Module installed in X2 Controller

WAND MODULE	
Model	Description
WAND	Bluetooth and Wi-Fi Module for Hydrawise Irrigation Management Platform
X2	See page 117 for model chart

WAND INSTALLATION



Compatible with:



X2 Controller
Page 117



ROAM Remote
Page 146
ROAM XL Remote
Page 147



Rain-Clik™ Sensor
Page 154



Smart WaterMark

Recognised as a responsible water-saving tool

The Bluetooth® word mark and logos are registered trademarks owned by Bluetooth SIG Inc., and any use of such marks by Hunter Industries is under licence. Amazon Alexa is a trademark of Amazon.com Inc. or its affiliates. Control4 is a registered trademark of Control4 Corporation in the United States and/or other countries. HomeSeer is a trademark of HomeSeer Technologies LLC.

PRO-HC

Use this rugged, cost-effective, professional-grade Wi-Fi controller for residential and light commercial applications.

KEY BENEFITS

- Number of stations:
 - 6, 12, or 24 (fixed models)
- Standard programming option allows for 6 independent irrigation programs and 6 start times per program
- Advanced programming option provides station-based programming with up to 6 total start times available
- 2 sensor inputs available for use with any Klik Sensor and HC Flow Meter
- 1 P/MV output for pump start relay and master valve activation
- Wi-Fi enabled for quick connection to Hydrowise™ Software
- 7 cm full-colour touchscreen display for simple programming at the control panel
- Built-in milliamp sensor for wire fault detection and alerts

OPERATING SPECIFICATIONS

- Transformer input: 120 VAC or 230 VAC
- Transformer output (24 VAC): 1 A
- Station output (24 VAC): 0.56 A
- P/MV output (24 VAC): 0.28 A
- 2.4 GHz (only) Wi-Fi router compatible, 802.11 b/g/n 20 MHz
- Supported security protocols: WPA/WPA2 Personal (only), TLS
- Approvals: IP44 (outdoor), UL, cUL, FCC, CE, UKCA, RCM, ISED
- Warranty period: 2 years

USER-INSTALLED OPTIONS

- Wireless HC Flow Meter option permits wireless flow monitoring for Hydrowise-enabled systems

Try Hydrowise Software today at hydrowise.com.



Pro-HC
(indoor/outdoor)
Height: 22.8 cm
Width: 25 cm
Depth: 10 cm

PRO-HC - SPECIFICATION BUILDER: ORDER 1 + 2 + 3		
1 Model	2 Transformer	3 Options
PHC-6 = 6-station controller	00 = 120 VAC	(blank) = U.S. cable and plug
PHC-12 = 12-station controller	01 = 230 VAC	E = 230 VAC with European cable and plug
PHC-24 = 24-station controller		A = 230 VAC with Australian cable and plug

Example:

PHC-2400 = 24-station, plastic wall mount cabinet, 120 VAC with U.S. cable and plug

PHC-1201-E = 12-station, plastic wall mount cabinet, 230 VAC with European cable and plug

Compatible with:

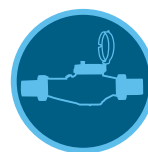

HC Flow Meter
Page 158



Soil-Clik™ Sensor
Page 157



Rain-Clik™ Sensor
Page 154



Smart WaterMark

Recognised as a responsible water-saving tool

HPC

This smart and flexible control solution combines the modularity of the popular Pro-C™ Controller with the power of Hydrawise™ Software.

Try Hydrawise Software today at hydrawise.com.

KEY BENEFITS

- Number of stations:
 - Conventional wiring from 4 to 23 stations
 - Hybrid EZ Decoder System option up to 32 total stations (28 stations maximum if two-wire only)
- Standard programming option allows for 6 independent irrigation programs and 6 start times per program
- Advanced programming option provides station-based programming with up to 6 total start times available
- 2 sensor inputs available for use with any Klik Sensor and HC Flow Meter
- 1 P/MV output for pump start relay and master valve activation
- Wi-Fi enabled for quick connection to Hydrawise Software
- 7 cm full-colour touchscreen display for simple programming at the control panel
- Built-in milliamp sensor for wire fault detection and alerts

OPERATING SPECIFICATIONS

- Transformer input: 120 or 230 VAC
- Transformer output (24 VAC): 1 A
- Station output (24 VAC): 0.56 A
- P/MV output (24 VAC): 0.28 A
- 2.4 GHz (only) Wi-Fi router compatible, 802.11 b/g/n 20 MHz
- Supported security protocols: WPA/WPA2 Personal (only), TLS
- Approvals: IP44 (outdoor), UL, cUL, FCC, CE, UKCA, RCM, ISED
- Warranty period: 2 years

USER-INSTALLED OPTIONS

- Wireless HC Flow Meter option permits wireless flow monitoring for Hydrawise enabled systems

HPC	
Model	Description
HPC-400	4-station base model, plastic wall mount cabinet, 120 VAC with U.S. cable and plug
HPC-401-E	4-station base model, plastic wall mount cabinet, 230 VAC with European cable and plug
HPC-401-A	4-station base model, plastic wall mount cabinet, 230 VAC with Australian cable and plug
HPC-FP	Hydrawise retrofit face panel for Pro-C Controllers (March 2014 or newer models)

PC-SERIES STATION EXPANSION	
Model	Description
PCM-300	3-station plug-in module
PCM-900	9-station plug-in module
PCM-1600	16-station plug-in module
PC-DM	EZ Decoder output module



HPC
(plastic indoor/outdoor)
Height: 22.9 cm
Width: 25.4 cm
Depth: 11.4 cm



HPC Face Panel

Compatible with:

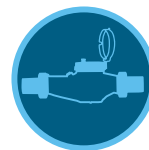

HC Flow Meter
Page 158



ROAM Remote
Page 146
ROAM XL Remote
Page 147

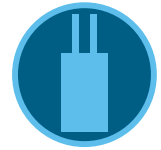

EZ Decoder System
Page 142



Smart WaterMark
Recognised as a responsible water-saving tool

HCC

Bring the power of Hydrowise™ Software to residential, commercial, and public-sector projects with this affordable powerhouse.

Try Hydrowise Software today at hydrowise.com.

KEY BENEFITS

- Number of stations:
 - Conventional: 8 to 38 (plastic), 8 to 54 (metal and pedestals)
 - With two-wire EZDS: up to 54 (all enclosure options)
- Any 2 programs or stations can operate simultaneously to improve irrigation efficiency
- 2 sensor inputs available for use with any Klik Sensors and HC Flow Meter
- 1 P/MV output for pump start relay and master valve activation
- 8 cm full-colour touchscreen display for simple programming at the control panel
- Built-in milliamp sensor for wire fault detection and alerts

OPERATING SPECIFICATIONS

- Transformer input: 120/230 VAC
- Transformer output (24 VAC): 1.4 A
- Station output (24 VAC): 0.56 A
- P/MV output (24 VAC): 0.56 A
- Run a maximum of 4 Hunter solenoids 1.04 A at once
- 2.4 GHz (only) Wi-Fi router compatible, 802.11 b/g/n 20 MHz
- Supported security protocols: WPA/WPA2 Personal (only), TLS
- Approvals: Plastic Wall Mount IP55 (outdoor), Plastic Pedestal IP24, Metal wall-mounted enclosure IP55 (outdoor), Metal Pedestal IP55 (outdoor), UL, cUL, FCC, CE, UKCA, RCM, ISED
- Warranty period: 2 years

USER-INSTALLED OPTIONS

- Wireless HC Flow Meter option permits wireless flow monitoring for Hydrowise enabled systems
- Compatible with ROAM Remote and ROAM XL Remote; see pages 146 and 147

HCC	
Model	Description
HCC-800-PL	8-station base model, plastic outdoor, wall mount
HCC-800-M	8-station base model, grey metal outdoor, wall mount
HCC-800-SS	8-station base model, stainless steel, wall mount
HCC-800-PP	8-station base model, plastic pedestal
HCC-FPUP	Retrofit upgrade kit for ICC and ICC2 Controllers
ICC-PED	Grey pedestal for metal wall mount cabinet
ICC-PED-SS	Stainless steel pedestal for stainless steel wall mount
ICC-PWB	Optional pedestal wiring board for metal pedestals
ANT-EXT-KIT	Universal antenna extension kit

HCC SERIES STATION EXPANSION	
Model	Description
ICM-400	4-station plug-in module with enhanced surge protection
ICM-800	8-station plug-in module with enhanced surge protection
ICM-2200	22-station expansion module (maximum one per controller)
EZDS	See page 142 for model chart



Plastic
Height: 30.5 cm
Width: 35 cm
Depth: 12.7 cm

Metal
(grey or stainless)
Height: 40.6 cm
Width: 33 cm
Depth: 12.7 cm



Metal Pedestal
(metal/stainless)
Height: 91.4 cm
Width: 29.2 cm
Depth: 12.7 cm



Plastic Pedestal
Height: 99 cm
Width: 61 cm
Depth: 43 cm

Compatible with:

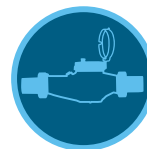

HC Flow Meter
Page 158

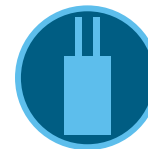

EZ Decoder System
Page 142



Rain-Klik™ Sensor
Page 154



Smart WaterMark
Recognised as a responsible water-saving tool



CENTRALUS™ CONTROLLERS



Manage large, complex systems from your fingertips with the cloud-based Centralus Irrigation Management Platform. Simple plug-in communication modules provide powerful internet connectivity and mobile control for Hunter's commercial-grade ACC2, ICC2, and Pro-C™ Controllers.

CENTRALUS CONTROLLER COMPARISON CHART

CONTROLLER MODELS	MAXIMUM STATIONS	SENSOR INPUTS	TWO-WIRE	FLOW*	REMOTE CONTROL	WEB ACCESS
ACC2	54, 225 two-wire	3 Clik, 1 Solar Sync, 6 Flow	ICD, 225 stations	HFS, WFS	ROAM, ROAM XL, Smartphone	Centralus: Wi-Fi, LAN, Cellular
ICC2	54	1 Clik or Solar Sync, 1 Flow	EZDS, 54 stations	HFS, WFS, HC Flow Meter	ROAM, ROAM XL, Smartphone	Centralus: Wi-Fi, LAN, Cellular
Pro-C	32	1 Clik, 1 Solar Sync or Flow	EZDS, 28 stations	HFS, WFS, HC Flow Meter	ROAM, ROAM XL, Smartphone	Centralus: Wi-Fi

*Centralus communication module required for flow sensor input with Pro-C and ICC2 Controllers

CENTRALUS™ SOFTWARE

Add cloud-based control and monitoring for Pro-C™, ICC2, and ACC2 Controllers with the mobile-friendly Centralus Irrigation Management Platform.

View Centralus Software today at centralus.hunterindustries.com.

KEY BENEFITS

- Browser-based programming and communication software
- Highly secure cloud access
- Map-based navigation and status
- Instant remote control from mobile device
- Flow monitoring and reporting
- Alarm reporting and detailed irrigation history reports
- Responsive web design configures for your device, allowing the same controls from your smartphone, tablet, or desktop
- Operable in many international languages
- Wi-Fi, Ethernet, or cellular connectivity options
- Manage Solar Sync™ Sensor adjustments and delay settings for greater water savings
- Organise maintenance teams and their controllers into management groups

OPERATING SPECIFICATIONS

- Operates in most modern browsers
- Secure internet connection for web-hosted application

USER-INSTALLED OPTIONS

- ET-based Solar Sync Sensor (one per controller); **see page 156**
- Flow sensors including the Flow-Sync™ Sensor, Wireless Flow Sensor, HC Flow Meter, and other approved equals
- Connected controllers are compatible with licence-free ROAM/ROAM XL Remotes (pre-wired controller connection)

COMMUNICATION OPTIONS

- Ethernet with RJ-45 connection, low data requirements
- 2.4 GHz (only) Wi-Fi router compatible, 802.11 b/g/n
- Supported security protocols: WPA/WPA2 Personal (only), TLS
- Cellular connectivity with ICC2 and ACC2 Controllers

COMMUNICATIONS	
Model	Description
PC-WIFI	Pro-C Wi-Fi connection
WIFIKIT	ICC2 Wi-Fi connection
LANKIT	ICC2 LAN (Ethernet) connection
CELLKIT	ICC2 cellular connection (service plan required)
A2C-WIFI*	ACC2 Wi-Fi connection
A2C-LAN	ACC2 LAN (Ethernet) connection
A2C-CELL-E*	Cellular Communication Module (3G LTE) for ACC2 Controllers
A2C-LTEM	ACC2 4G Global connection (monthly service plan required)

Note
* SASO Quality Mark Certified

COMMUNICATIONS ACCESSORIES	
Model	Description
ANT-EXT-KIT	Universal Antenna Extension Kit

ACC2 COMMUNICATION MODULE INSTALLATION



A2C Communication Modules are installed behind the ACC2 Facepack

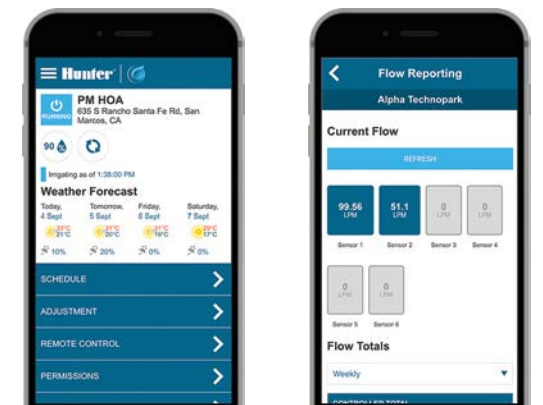

Manage and monitor controllers from anywhere



Mobile-Friendly

The mobile-friendly Centralus Irrigation Management Platform provides highly secure, comprehensive cloud-based control and monitoring features. The connectivity allows you to view a controller's status, change settings, view forecasts, save water, and receive instant notification of important system alarms.

User-Friendly

The addition of internet access brings dial-based Pro-C, ICC2, and ACC2 Controllers seamlessly into the world of next-generation irrigation control. From the intuitive Centralus dashboard, it's now easier than ever to add alarm monitoring, location information, remote operation, and scheduling to Pro-C, ICC2, and ACC2 Controllers.

Easy to Upgrade

To upgrade to Centralus control, add a simple Wi-Fi, Ethernet (LAN), or cellular communication module to the controller:

- Pro-C: PC-WIFI
- ICC2: WIFIKIT, LANKIT, or CELLKIT (4G)
- ACC2: A2C-WIFI, A2C-LAN, A2C-LTEM (4G), or A2C-CELL-E (3G only)



Centralus™ Software

Enable Pro-C, ICC2, and ACC2 Controllers with next-generation management technology. To learn more, visit centralus.hunterindustries.com.



PC-WIFI
Height: 11 cm
Width: 6 cm
Depth: 1.5 cm



WIFIKIT
Height: 10.8 cm
Width: 6.4 cm (installed)
Depth: 3.5 cm



LANKIT
Height: 10.8 cm
Width: 6.4 cm (installed)
Depth: 3.5 cm



CELLKIT
Height: 8 cm
Width: 6 cm
Depth: 4 cm



A2C-WIFI*
Height: 7.6 cm
Width: 5.7 cm
Depth: 2.5 cm



A2C-LAN
Height: 7.6 cm
Width: 5.7 cm
Depth: 2.5 cm



A2C-LTEM
Height: 7.6 cm
Width: 5.7 cm
Depth: 2.5 cm



Smart WaterMark
Recognised as a responsible water-saving tool when used with a Solar Sync Sensor

ACC2

The multi-flow monitoring and management capabilities of the ACC2 Controller, combined with the option to upgrade to cloud-based Centralus™ control, make it the best choice for complex projects.

KEY BENEFITS

- Number of stations:
 - 12 to 225, for large projects
 - Language-selectable, high-visibility display
- Up to 6 flow sensor inputs and 6 P/MV outputs
- 32 automatic programs (10 start times each) for precise plant management
- Block function to group stations and consolidate large systems
- Add a Solar Sync™ Sensor to save water based on local weather conditions
- Real-time flow monitoring detects and diagnoses leaks in up to 6 flow zones
- Flow management optimises watering at safe velocities
- High-visibility, full-colour display with reversible facepack
- Conditional Response “if/then” programming for active responses to sensor inputs
- User management password protection, with two levels of access
- Optional plug-in communications modules for cloud or network control
- Detailed alarm logs
- Extreme service lightning protection
- Easy Retrieve™ Memory programming backup and restore
- Non-Water Windows to inhibit accidental irrigation

OPERATING SPECIFICATIONS

- Transformer input: 120/230 VAC
- Maximum AC current draw: 120 VAC, 2 A/230 VAC, 1 A
- Transformer output: 24 VAC, ~3 A
- P/MV outputs (24 VAC): Up to 6; 3 included, 0.8 A each
- Sensor inputs: 3 Clik, 1 Solar Sync, and up to 6 Flow Sensors (3 included)
- Approvals: Wall Mounts IP55 (outdoor), Plastic Pedestal IP24, UL, cUL, FCC, CE, UKCA, RCM, ISED, SASO Quality Mark Certified*
- Warranty period: 5 years

USER-INSTALLED OPTIONS

- Centralus central control available with Wi-Fi, LAN, and cellular connections
- SCADA/automation compatible with BACnet, Modbus, RESTful API, and other protocols via Hunter field servers; **see page 132**

View Centralus Software today at centralus.hunterindustries.com.



Metal Wall Mount
(grey or stainless steel)
Height: 40 cm
Width: 40 cm
Depth: 18 cm



Plastic Wall Mount
Height: 42 cm
Width: 42 cm
Depth: 17 cm



Metal Pedestals
(grey or stainless steel)
Height: 94 cm
Width: 39 cm
Depth: 13 cm



Plastic Pedestal
Height: 97 cm
Width: 55 cm
Depth: 40 cm

Compatible with:



Solar Sync Sensor
Page 156



Flow-Sync™ Sensor
Page 161
Wireless Flow Sensor
Page 162



ROAM Remote
Page 146
ROAM XL Remote
Page 147



Smart WaterMark

Recognised as a responsible water-saving tool when used with a Solar Sync Sensor

ADDITIONAL SPECIFICATIONS BY MODEL

ACC2 CONVENTIONAL

- Number of stations:
 - 12 to 54, for large projects
- Simultaneous station operation: up to 14 solenoids
- Expands in 6-station increments
- Extreme service lightning protection, standard on all A2M-600 Output Modules
- Station outputs: 0.8 A each

ACC2 CONVENTIONAL MODELS	
Model	Description
A2C-1200-M	12-station base unit controller, expands to 54 stations, grey steel wall mount, outdoor
A2C-1200-P	12-station base unit controller, expands to 54 stations, plastic outdoor wall mount
A2C-1200-SS	12-station base unit controller, expands to 54 stations, stainless steel wall mount, outdoor
A2C-1200-PP	12-station base unit controller, expands to 54 stations, plastic pedestal
A2M-600	6-station plug-in module for use with the A2C-1200 series controllers

ACC2 ACCESSORIES FOR ALL MODELS

ACC2 ACCESSORIES	
Model	Description
A2C-F3	Optional flow meter expansion module (adds 3 inputs)
A2C-LEDKT	External status light shows controller status with door closed
A2C-WIFI*	ACC2 Wi-Fi connection
A2C-LAN	ACC2 LAN (Ethernet) connection
A2C-LTEM	Cellular Communication Module (4G LTE) for ACC2 Controllers (monthly service plan required)
A2C-CELL-E*	Cellular Communication Module (3G only) for use in areas where 4G is not available
ACC-PED	Grey pedestal for wall mount
PED-SS	Stainless steel pedestal for wall mount

Note

*SASO Quality Mark Certified

ACC2 DECODER

- Number of stations:
 - 75, 150, or 225, for large projects
- Simultaneous station operation: up to 30 solenoids
- Operates Hunter's premium ICD Decoders over ID wire:
 - Up to 3 km (2 mm² wire)
 - Up to 4.5 km (3 mm² wire)
- See complete ICD Decoder key benefits and specifications on [page 140](#)
- Up to 3 two-wire paths per output module
- Diagnostics including decoder inventory, wire tracker, solenoid finder, and more

ACC2 DECODER MODELS	
Model	Description
A2C-75D-M*	75-station base model, grey metal outdoor, wall mount
A2C-75D-P*	75-station base model, plastic outdoor, wall mount
A2C-75D-SS*	75-station base model, stainless steel, wall mount
A2C-75D-PP*	75-station base model, plastic pedestal
A2C-D75*	75-station decoder expansion module

Note

*SASO Quality Mark Certified

ACC2 REVERSIBLE FACEPACK AND AUTOMATIC DIAGNOSTIC MODE



ICC2

This flexible control system can run any combination of conventional or two-wire outputs with the option to upgrade to cloud-based Centralus™ control.

KEY BENEFITS

- Number of stations:
 - Conventional: 8 to 38 (plastic), 8 to 54 (metal and pedestal)
 - With two-wire EZDS: up to 54 (all enclosure options)
- 4 automatic irrigation programs with 8 start times per program and 12-hour run times per station
- Any 2 programs can operate simultaneously to improve irrigation efficiency
- 1 sensor input available for use with Solar Sync™ or any Clik Sensors
- 1 flow sensor input available with Centralus communication modules
- 1 P/MV output for pump start relay and master valve activation
- Upgradable to Centralus Software for web-based central control options

OPERATING SPECIFICATIONS

- Transformer input: 120/230 VAC
- Transformer output (24 VAC): 1.4 A
- Station output (24 VAC): 0.56 A
- P/MV output (24 VAC): 0.56 A
- Approvals: Wall Mounts IP55 (outdoor), Plastic Pedestal IP24, UL, cUL, FCC, CE, UKCA, RCM, ISED
- Warranty period: 5 years

USER-INSTALLED OPTIONS

- WIFIKIT, LANKIT, or CELLKIT communications for cloud-based Centralus control
- Compatible with Hunter Flow-Sync™ Sensor and HC Flow Meter for flow monitoring and high-flow shutdown capabilities via Centralus Software
- SCADA/automation compatible with BACnet, Modbus, RESTful API, and other protocols via Hunter field servers; **see page 132**

View Centralus Software today
at centralus.hunterindustries.com



Plastic
Height: 30.5 cm
Width: 35 cm
Depth: 12.7 cm

Metal
(grey or stainless steel)
Height: 40.6 cm
Width: 33 cm
Depth: 12.7 cm



Metal Pedestal
(grey or stainless steel)
Height: 91.4 cm
Width: 29.2 cm
Depth: 12.7 cm



Plastic Pedestal
Height: 99 cm
Width: 61 cm
Depth: 43 cm

Compatible with:

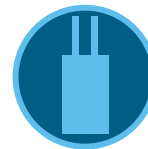

EZ Decoder System
Page 142



Solar Sync™ Sensor
Page 156



ROAM Remote
Page 146
ROAM XL Remote
Page 147

ICC2



Smart WaterMark
Recognised as a responsible water-saving tool when used with a Solar Sync Sensor

ICC2	
Model	Description
I2C-800-PL	8-station base model, plastic outdoor wall mount
I2C-800-M	8-station base model, grey metal outdoor, wall mount
I2C-800-SS	8-station base model, stainless steel, wall mount
I2C-800-PP	8-station base model, plastic pedestal
ICC-FPUP2	ICC2 Retrofit Kit for original ICC Controllers
ICC-PED	Grey pedestal for metal controller mount
ICC-PED-SS	Stainless steel pedestal for stainless steel controller mount
ICC-PWB	Optional pedestal wiring board for metal pedestals

ICC2 SERIES STATION EXPANSION	
Model	Description
ICM-400	4-station plug-in module with enhanced surge suppression
ICM-800	8-station plug-in module with enhanced surge suppression
ICM-2200	22-station expansion module (one per controller)
EZDS	See page 142 for model chart



ICM400
Height: 11.5 cm
Width: 6.5 cm
Depth: 4 cm



ICM800
Height: 11.5 cm
Width: 6.5 cm
Depth: 4 cm



ICM2200
Height: 23.5 cm
Width: 7 cm
Depth: 4.5 cm



EZ-DM
Height: 11.5 cm
Width: 6.5 cm
Depth: 4 cm



EZ-1
Height: 7 cm
Width: 4 cm
Depth: 2 cm

PRO-C™

Simple programming and flexible station expansion make the Pro-C Controller the professional's choice for residential and light commercial systems.

KEY BENEFITS

- Number of stations:
 - Modular Pro-C
 - Conventional wiring from 4 to 23 stations
 - Hybrid EZ Decoder option up to 32 total stations (28 stations max. if two-wire only)
- 3 automatic irrigation programs with 4 start times per program and 6-hour run times per station
- 2 sensor inputs available for use with Solar Sync™ or any Klik Sensors
- 1 flow sensor input available with Centralus Wi-Fi module
- 1 P/MV output for pump start relay and master valve activation
- High-visibility, backlit display for simple programming in any light
- Optional Seconds Mode allows for station run times with seconds resolution from 1 second to 5 minutes
- QuickCheck™ Technology provides simple diagnostics of faulty field wiring
- Backward compatible with previous modular PC-400 models dated 2014 to 2023

OPERATING SPECIFICATIONS

- Transformer input: 120 VAC or 230 VAC
- Transformer output (24 VAC): 1 A
- Station output (24 VAC): 0.56 A
- P/MV output (24 VAC): 0.28 A
- Approvals: IP44 (outdoor), UL, cUL, FCC, CE, UKCA, RCM, ISED
- Warranty period: 2 years

USER-INSTALLED OPTIONS

- PC-WIFI communication module for cloud-based Centralus control
- Compatible with Hunter Flow-Sync™ Sensor and HC Flow Meter for flow monitoring and high-flow shutdown capabilities via Centralus Software



Plastic Outdoor

Height: 22.9 cm
Width: 25.4 cm
Depth: 11.4 cm

P2C-400 CONTROLLER WITH 2 SENSOR INPUTS

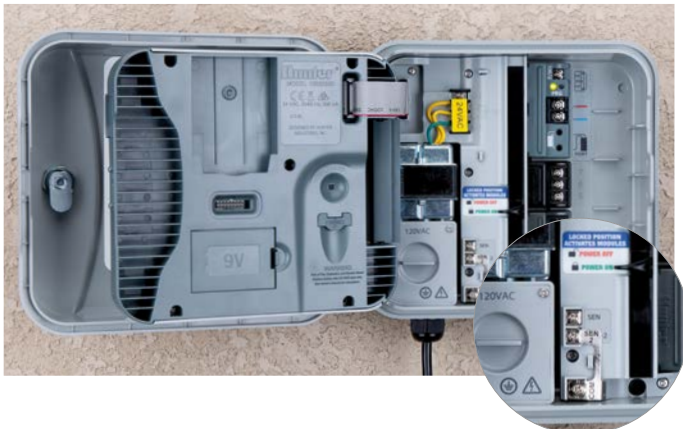

Compatible with:



**Solar Sync
Sensor**
Page 156



ROAM Remote
Page 146
ROAM XL Remote
Page 147

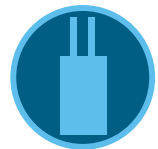

**EZ Decoder
System**
Page 142



Smart WaterMark

Recognised as a responsible water-saving tool when used with a Solar Sync Sensor

PRO-C	
Model	Description
P2C-400	4-station base, plastic wall mount cabinet, 120 VAC with U.S. cable and plug
P2C-401-E	4-station base, plastic wall mount cabinet, 230 VAC with European cable and plug
P2C-401-A	4-station base, plastic wall mount cabinet, 230 VAC with Australian cable and plug

PC-SERIES STATION EXPANSION	
Model	Description
PCM-300	3-station plug-in module
PCM-900	9-station plug-in module
PCM-1600	16-station plug-in module
PC-DM	EZ Decoder Output Module



PCM300
 Height: 7.5 cm
 Width: 3.5 cm
 Depth: 3 cm



PCM900
 Height: 7.5 cm
 Width: 7.5 cm
 Depth: 3 cm



PCM1600
 Height: 9 cm
 Width: 7.5 cm
 Depth: 3.5 cm



PC-DM
 Height: 7.5 cm
 Width: 7.5 cm
 Depth: 3 cm

HUNTER FIELD SERVERS

These high-performance devices make it easy to communicate directly with Hunter ACC2 and ICC2 Controllers from centralised command centers.

KEY BENEFITS

- Field server for BACnet, Modbus, RESTful API, and over 120 other automation protocols
- Up to 3,000 data points with complete documentation and demo software with Hunter licence agreement
- Integrates controllers directly into SCADA, Smart City, and BMS applications
- Allows total access to all controller commands, reports, and features from the customer's integration software
- Does not require internet connection or other proprietary control software
- 2 x RJ-45 receptacles for system and controller connections
- 1 x RS-485/RS-232 and 1 x RS-485
- DIN rail mounting included
- Made in USA

OPERATING SPECIFICATIONS

- Serial (galvanic isolation): 1 x RS-485/RS-232 and 1 x RS-485
- Baud: 9600, 19200, 38400, 57600, 76800, 115000
- Ethernet: 2 x 10/100BaseT, MDIX, DHCP
- Operating temperature: -20°C to 70°C
- Relative humidity: 10% to 95% RH non-condensing



Hunter Field Server

Height: 10.2 cm

Width: 2.8 cm

Depth: 6.8 cm



Field Server Connections

HUNTER FIELD SERVER MODEL CHART

Model	Description
FS-3000	Field Server, 3,000 data points
FS-1000	Field Server, 1,000 data points



BATTERY-OPERATED CONTROLLERS

BATTERY-OPERATED CONTROLLER COMPARISON CHART

CONTROLLER MODELS	MAXIMUM STATIONS	SENSOR INPUTS	REMOTE CONTROL	SOLAR
BTT	2	N/A	BTT Bluetooth® App	N/A
NODE	6	1	N/A	SPNODE
NODE-BT	4	2	NODE-BT Bluetooth App	SPNODEBT
XC Hybrid	12	1	N/A	SPXCH, XCH-600-SSP, XCH-1200-SSP

Take advantage of smartphone-controlled, above-ground irrigation for easier access to the hose tap.

KEY BENEFITS

- Number of zones:
 - 1 or 2 (fixed models)
- Battery-operated tap timer with Bluetooth® control
- 1 smartphone manages an unlimited number of controllers
- 1-second to 24-hour run time with 4 start times
- Cycling mode repeats continuously within user-defined water windows, perfect for drip systems or germinating seeds
- Suspend irrigation up to 99 days during the off-season, perfect for seasonal markets
- Manual push-button operation for quick operation without a smartphone
- Automatic water shutoff after 1 hour prevents water waste
- Blinking LED low-battery alert indicates battery replacement
- Alkaline batteries included for quicker installation
- Includes quick coupler adapter

OPERATING SPECIFICATIONS

- Two 1.5V AA alkaline batteries (included)
- Flow rate: 1.9 to 2,271 L/H
- Recommended pressure: 0.5 to 8 bar (50 to 800 kPa)
- See friction loss chart on **page 220**
- Bluetooth 4.0/4.2 (BLE)
- Approvals: Plastic IPX6 (outdoor), UL, cUL, FCC, CE, UKCA, RCM, ISED
- Warranty period: 2 years

APP SPECIFICATIONS

- iOS® 9.0 or above, Android™ 4.4 or above
- Maximum communication distance: 10 m
- See all app features at hunter.info/BTT



BTT-101
 Inlet diameter: ¾" and 1"
 Outlet diameter: ¾"
 Height: 16.8 cm
 Width: 12 cm
 Depth: 6 cm



BTT-201
 Inlet diameter: ¾" and 1"
 Outlet diameter: ¾"
 Height: 15.7 cm
 Width: 13.5 cm
 Depth: 6 cm



BTT-LOC
 (optional)
 Inlet diameter: ¾"
 Outlet diameter: 16-18 mm dripline
 Height: 7 cm
 Width: 3 cm



Pressure Regulator
 (optional)
 Inlet diameter: ¾"
 Outlet diameter: ¾"
 Height: 7 cm
 Width: 4 cm

BTT WITH HUNTER DRIPLINE (HDL) INSTALLATION



To control drip irrigation applications with BTT, use the BTT-LOC Drip Adapter, which connects BTT to HDL surface and subsurface systems.

Compatible with:

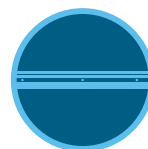

HDL Dripline
 Page 171

BTT	
Model	Description
BTT-101	1-zone Bluetooth Tap Timer, 1" (25 mm) BSP and ¾" hose thread, quick coupler adapter
BTT-201	2-zone Bluetooth Tap Timer, 1" (25 mm) BSP and ¾" hose thread, quick coupler adapter

BTT ACCESSORIES	
Model	Description
BTT-LOC	BTT adapter for 16 to 18 mm dripline
PRLG203FH3MH	1.4 bar (140 kPa) pressure regulator, ¾" hose thread
PRLG253FH3MH	1.7 bar (170 kPa) pressure regulator, ¾" hose thread
PRLG303FH3MH	2 bar (200 kPa) pressure regulator, ¾" hose thread
PRLG403FH3MH	2.8 bar (280 kPa) pressure regulator, ¾" hose thread

The Bluetooth® word mark and logos are registered trademarks owned by Bluetooth SIG Inc. and any use of such marks by Hunter Industries is under licence. iOS is a trademark or registered trademark of Cisco in the U.S. and other countries and is used under licence. Android is a trademark of Google LLC.

NODE

This battery-operated, waterproof controller offers automatic irrigation control for temporary irrigation and sites without electricity.

KEY BENEFITS

- Number of stations:
 - 1, 2, 4, or 6 (fixed models)
- Battery-operated controller for automatic irrigation
- Battery-life indicator for battery replacement
- Waterproof enclosure seal protects against water ingress
- 3 flexible programs with 4 start times each and up to 6-hour run times
- Suspend irrigation up to 99 days during the off-season
- Easy Retrieve™ Memory backs up the full irrigation schedule if ever changed
- Seasonal adjustment for quicker schedule adjustments without changing run times
- Solar panel provides maintenance-free operation
- Mounts to Hunter solenoids, pipes, flat surfaces, or inside the valve box

OPERATING SPECIFICATIONS

- One or two 9 V alkaline batteries or 800 mAh solar panel with charging cell
- Operates Hunter DC-Latching Solenoids; **see page 103**
- 30 m maximum wire runs, 1 mm² wire only
- Solar panel includes 12 m of direct-burial wire
- Station output: 9-11 VDC
- P/MV output: 9-11 VDC (multi-station models)
- Sensor inputs: 1 (wired rain, freeze, or wind only)
- Approvals: IP68 (submersible), UL, cUL, FCC, CE, UKCA, RCM, ISED
- Warranty period: 2 years

NODE	
Model	Description
NODE-100	Single-station battery controller and DC-Latching Solenoid
NODE-100-LS	Single-station battery controller
NODE-200	2-station battery controller
NODE-400	4-station battery controller
NODE-600	6-station battery controller
NODE-100-VALVE	Single-station battery controller with PGV-101G Valve and DC-Latching Solenoid (NPT threads)
NODE-100-VALVE-B	Single-station battery controller with PGV-101G-B Valve and DC-Latching Solenoid (BSP threads)
SPNODE	Solar Panel Kit for NODE controllers
458200	DC-Latching Solenoid (for all Hunter valves)



NODE
Height: 6.4 cm
Diameter: 8.9 cm



SPNODE
Solar Panel Kit (optional)
Height: 8 cm
Length: 25 cm
Width: 8 cm
Controller to solar panel: 30 m maximum
1 mm² direct-burial wire

NODE



Compatible with:



**Mini-Clik™
Sensor**
Page 155



**Waterproof
Wire Connector**
Page 145

NODE-BT

Manage gardens, greenhouses, traffic medians, and temporary irrigation sites from a smartphone without opening the valve box.

KEY BENEFITS

- Number of stations:
 - 1, 2, or 4 (fixed models)
- Bluetooth® battery-operated controller for automatic irrigation
- Active station LEDs and battery-life LED indicator for replacement
- 3 programs with 8 start times each and 1 second to 12-hour run times
- Suspend irrigation up to 99 days during the off-season
- Manual push-button operation for quick operation without a smartphone
- Delay Between Stations for slow-closing valves or pump recharge
- Cycle and Soak prevents water waste and runoff in areas with elevation changes or tight soils
- Monthly and global seasonal adjustment for quicker schedule adjustments without changing run times

OPERATING SPECIFICATIONS

- One or two 9 V alkaline batteries
- Operates Hunter DC-Latching Solenoids; **see page 103**
- 30 m maximum wire runs, 1 mm² wire only
- Station output: 9–11 VDC
- P/MV output: 9–11 VDC (multi-station models)
- Sensor inputs: 2 (wired rain, freeze, or wind only)
- Bluetooth 5.0 (BLE)
- Approvals: IP68 (submersible), UL, cUL, FCC, CE, UKCA, RCM, ISED
- Warranty period: 2 years

APP SPECIFICATIONS

- iOS® 9.0 or above, Android™ 5.0 or above
- Maximum communication distance: 15 m
- See all app features at hunter.info/NodeBT

NODE-BT	
Model	Description
NODE-BT-100	Single-station Bluetooth battery controller and DC-Latching Solenoid
NODE-BT-100-LS	Single-station Bluetooth battery controller
NODE-BT-200	2-station Bluetooth battery controller
NODE-BT-400	4-station Bluetooth battery controller
NODE-BT-100-VALVE	Single-station Bluetooth battery controller with PGV-101G Valve and DC-Latching Solenoid (NPT threads)
NODE-BT-100-VALVE-B	Single-station Bluetooth battery controller with PGV-101G-B Valve and DC-Latching Solenoid (BSP threads)
SC-PROBE	Soil probe for moisture sensing (module is not used)
SP-NODE-BT	Solar Panel Kit for NODE-BT Controllers
458200	DC-Latching Solenoid

The Bluetooth® word mark and logos are registered trademarks owned by Bluetooth SIG Inc., and any use of such marks by Hunter Industries is under licence. iOS is a trademark or registered trademark of Cisco in the U.S. and other countries, and is used under licence. Android is a trademark of Google LLC.



NODE-BT
Height: 8.3 cm
Diameter: 8.9 cm



SC-PROBE
Soil Moisture Sensor (optional)
Height: 8.3 cm
Diameter: 2.5 cm



SP-NODE-BT
NODE-BT Solar Panel
Height: 7.6 cm
Width: 4.5 cm
Depth: 24 cm

NODE-BT WITH PGV INSTALLATION

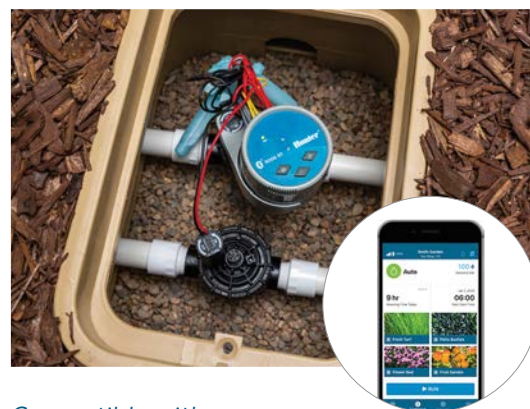

Compatible with:



Mini-Click™
Sensor
Page 155



Waterproof Wire
Connector
Page 145

XC HYBRID

Effectively manage landscapes where electricity is unavailable with this economical battery-operated or solar-powered controller.

KEY BENEFITS

- Number of stations:
 - 6 or 12 (fixed models)
- 3 power options: AC power, battery, or solar panel compatible with ambient light
- Stainless steel enclosure protects against vandalism
- 3 programs with 4 start times each and up to 4-hour run times
- Easy Retrieve™ Memory backs up the full irrigation schedule
- Delay Between Stations for slow-closing valves or pump recharge
- Seasonal adjustment for quicker schedule adjustments without changing run times
- Solar panel provides maintenance-free operation
- Mounts to flat surfaces or steel posts

OPERATING SPECIFICATIONS

- Plastic model operates six 1.5 V AA alkaline batteries
- Stainless steel model operates six 1.5 V C alkaline batteries
- Stainless steel solar model operates 800 mAh solar panel with charging cell
- Solar panel includes 12 m of direct-burial wire
- Controller to solar panel: 30 m maximum 1 mm² direct-burial wire
- All models operate optional 24 VAC plug-in wall adapter:
 - 120 VAC P/N 526500
 - 230 VAC Australian P/N 545500
 - 230 VAC European P/N 545700
- Operates Hunter DC-Latching Solenoids; **see page 103**
- Station output: 9 to 11 VDC
- P/MV output: 9 to 11 VDC
- Sensor inputs: 1 (wired rain, freeze, or wind only)
- Approvals: Plastic IP54 (outdoor), Stainless Steel IP24 (outdoor), UL, cUL, FCC, CE, UKCA, RCM, ISED
- Warranty period: 2 years



Plastic
Height: 22 cm
Width: 18 cm
Depth: 10 cm



Stainless Steel
Height: 25 cm
Width: 19 cm
Depth: 11 cm



Stainless Steel Solar
Height: 27 cm
Width: 19 cm
Depth: 11 cm



SPXCH
Solar Panel Kit (optional)
Height: 8 cm
Length: 25 cm
Width: 8 cm



XCHSPOLE
Pole-Mounting Kit (optional)
Height: 1.2 m

Compatible with:



Mini-Clik™ Sensor
Page 155

XC HYBRID	
Model	Description
XCH-600	6-station battery controller
XCH-600-SS	6-station battery controller, stainless steel
XCH-600-SSP	6-station controller, stainless steel, with mounted solar panel
XCH-1200	12-station battery controller
XCH-1200-SS	12-station battery controller, stainless steel
XCH-1200-SSP	12-station controller, stainless steel, with mounted solar panel
DCREL2	Latching sensor relay switch for pumps
458200	DC-Latching Solenoid (for all Hunter valves)

MAXIMUM WIRE RUNS	
Wire Size	Max. Distance
1.0 mm ²	168 m
1.2 mm ²	265 m
1.6 mm ²	420 m
2.0 mm ²	670 m

CONTROLLER DECODERS & ACCESSORIES



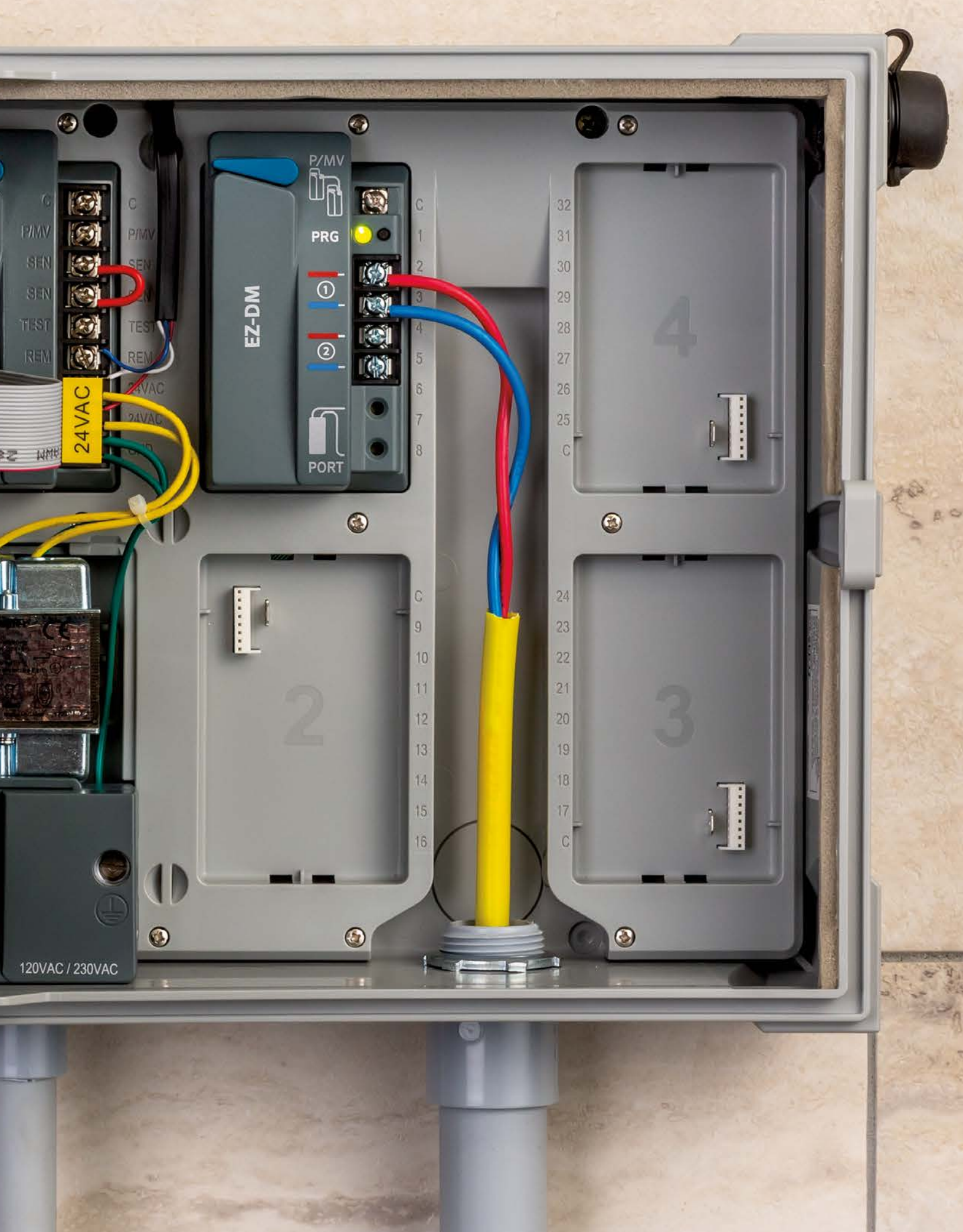

EZ-DM

P/MV

PRG

PORT

24VAC

C
P/MV
SEN
SEN
TEST
REM

C
P/MV
SEN
SEN
TEST
REM

C
1
2
3
4
5
6
7
8

32
31
30
29
28
27
26
25
C

C
9
10
11
12
13
14
15
16

24
23
22
21
20
19
18
17
C

120VAC / 230VAC

ICD

Hunter's premium two-wire decoders for long-distance, high-station-count ACC2 applications include two-way communications and integrated surge protection.

KEY BENEFITS

- ICD Decoders are compatible with ACC2 Decoder Controllers and legacy ACC-99D Decoder Controllers
- 1-, 2-, 4-, and 6-station versions provide maximum flexibility
- Sensor decoders allow Flow and Clik Sensor monitoring via the two-wire paths
- Field-programmable decoders accept station numbers directly, and do not require entering serial numbers into the control panel
 - Decoders can be programmed before installation at the controller interface
 - Use of the ICD-HP Programmer allows for wireless decoder programming or reprogramming after installation to the two-wire path
- Integrated surge protection eliminates the need for extra surge protection devices
- Colour-coded wiring connections simplify installation
- Industrial-grade, waterproof DRBY Splice Connectors included for two-wire path splices

OPERATING SPECIFICATIONS

- Maximum recommended distance, decoder to solenoid: 45 m
- Maximum distance to decoder via two-wire path:
 - 2 mm² wire path: 3 km
 - 3.3 mm² wire path: 4.5 km
- Approvals: UL, cUL, FCC, CE, UKCA, RCM
- Decoder rating: IP68 (submersible)
- Warranty period: 5 years

USER-INSTALLED OPTIONS

- Wireless handheld ICD-HP Programmer; **see page 141**
- DECSTAKE10 Universal Decoder Stake, 10-pack; **see page 144**



ICD-100, 200, ICD-SEN

Height: 92 mm
Width: 38 mm
Depth: 12.7 mm

ICD-400, 600

Height: 92 mm
Width: 46 mm
Depth: 38 mm

DECODER MODELS

Model	Description
ICD-100	Single-station decoder with surge suppression and ground wire
ICD-200	2-station decoder with surge suppression and ground wire
ICD-400	4-station decoder with surge suppression and ground wire
ICD-600	6-station decoder with surge suppression and ground wire
ICD-SEN	2-input sensor decoder with surge suppression and ground wire

ID WIRE MODEL GUIDE

2 mm ² Decoder Cable		3.3 mm ² Long-Range, Heavy-Duty Decoder Cable	
ID1GRY	Grey jacket	ID2GRY	Grey jacket
ID1PUR	Purple jacket	ID2PUR	Purple jacket
ID1YLW	Yellow jacket	ID2YLW	Yellow jacket
ID1ORG	Orange jacket	ID2ORG	Orange jacket
ID1BLU	Blue jacket	ID2BLU	Blue jacket
ID1TAN	Tan jacket	ID2TAN	Tan jacket

ID WIRE MAXIMUM WIRE RUNS

ID 1 Wire	ID 2 Wire
1,500 m with legacy DUAL™ systems	2,300 m with legacy DUAL systems
3 km with ICD systems	4.5 km with ICD systems

Compatible with:



**Waterproof
Splice Kit**
Page 145

ICD-HP PROGRAMMER

Gain wireless, handheld programming and diagnostic capabilities for Hunter ICD and DUAL™ Decoders.

KEY BENEFITS

- Program or re-program decoder stations, whether new or installed*
- Simplifies setup and diagnostics for sensor decoders
- Sensor test functions for Flow and Klik Sensors, plus built-in multimeter
- Communicates with decoder through plastic case: wireless electromagnetic induction saves waterproof connectors
- Compatible with Hunter ICD and legacy DUAL Decoders, as well as Pilot™ Two-Way Modules
- USB-powered for shop or office use; 4 AA batteries for field use
- All test leads and cables included in durable, foam-padded carrying case
- Turn decoder stations on and view solenoid status, current in milliamps, and more
- Waterproof programming cup
- Backlit adjustable display
- 6 operating languages
- * **Note:** ICD-HP Programmer is not compatible with EZ-1 Decoders

ELECTRICAL SPECIFICATIONS

- Power input: 4 AA batteries, or standard USB connector (included)
- Communications: wireless induction, range 25 mm
- Fused test leads for unpowered decoder functions

APPROVALS

- UL, cUL, FCC, CE, UKCA, RCM

ICD-HP	
Model	Description
ICD-HP	Wireless handheld decoder programmer, includes all test and power leads, programming cup, and rugged carrying case



ICD-HP

Height: 21 cm
Width: 9 cm
Depth: 5 cm

Packaged in an outdoor carrying case, this complete kit includes probes, induction cup, cable, USB power cable for bench use, and 4 AA batteries for fieldwork.

ICD-HP



EZ DECODER SYSTEM

Bring two-wire technology to more projects than ever before with the revolutionary, low-cost, and hassle-free EZ Decoder System for Pro-C™, HPC, ICC2, and HCC Controllers.

KEY BENEFITS

- Number of stations:
 - Pro-C/HPC: Up to 28, plus master valve
 - ICC2/HCC: Up to 54, plus master valve
- No special wire or connectors required
- No special grounding or surge arrestors required in-line
- Programmable decoders with no need to input individual serial numbers
- P/MV can activate via the two-wire path for distant installations
- EZ-1 Decoders have built-in status LED for positive diagnostics

OPERATING SPECIFICATIONS

- Electrical output on two-wire path: 24 VAC, 50/60 Hz
- Two-wire paths to the field:
 - EZ-DM: 2
 - PC-DM: 1
- Wire paths possible up to 1 km (see Wiring Table below)
- Each EZ-1 Decoder can activate two standard 24 VAC solenoids
- Operate any two decoders simultaneously for more efficient watering (ICC2 and HCC Controllers only)
- Approvals: UL, cUL, FCC, CE, UKCA, RCM, ISED
- EZ-1 Decoders are IP68 rated, submersible
- Warranty period: 3 years

USER-INSTALLED OPTIONS

- Centralus™ Software with Pro-C and ICC2 Controllers
- Hydrowise™ Software with HPC and HCC Controllers
- EZ-DT Diagnostic Tool for wireless diagnostics with EZ-1 Decoders
- DECSTAKE10 Universal Decoder Stake, 10-pack; **see page 144**
- Compatible with Waterproof Wire Connector; **see page 145**



Single-Station Decoder

Height: 73 mm
Width: 42 mm
Depth: 16 mm

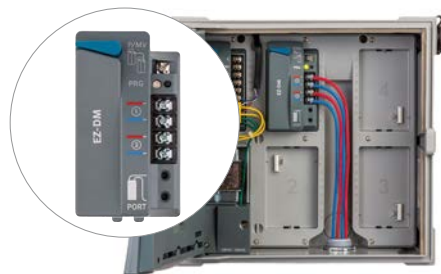

Decoder Output Module: EZ-DM

Height: 115 mm
Width: 64 mm
Depth: 42 mm

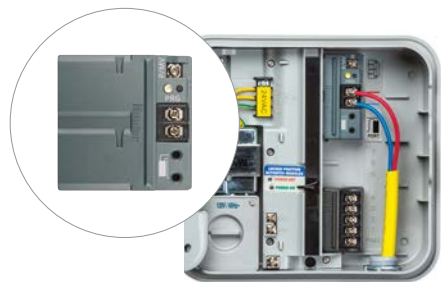

Decoder Output Module: PC-DM

Height: 76 mm
Width: 76 mm
Depth: 32 mm

Compatible with:



HCC Controller
Page 121



ICC2 Controller
Page 128



Pro-C Controller
Page 130

WIRING TABLE

International Wire Gauge	Distance, single solenoid	Distance, 2 solenoids per output
0.5 mm ²	167 m	83 m
0.8 mm ²	267 m	133 m
1 mm ²	333 m	167 m
1.5 mm ²	500 m	250 m
2.5 mm ²	833 m	417 m
4 mm ²	1,333 m	667 m

Note

Distances in the Wiring Table are calculated based on 50 Hz with a wire temperature of 50°C and a 10% safety factor.

DECODER MODELS

Model	Description
EZ-DM	Decoder output module for ICC2 and HCC Controllers
PC-DM	Decoder output module for Pro-C and HPC Controllers
EZ-1	Single-station decoder with status LED
EZ-DT	EZ-DT Diagnostic Tool

EZ-DT

Simplify maintenance of EZ Decoder Systems with the handheld, wireless EZ Decoder Diagnostic Tool.

KEY BENEFITS

- Wireless, handheld diagnostic tool for EZ-1 Decoders
- Detect faults and perform electrical troubleshooting in the field without uninstalling decoders
- Quickly read decoder status, station address, current draw, and two-wire voltage to simplify maintenance
- Program decoder station address via the wired connection to speed up installation and save time on-site
- Update controller facepack or decoder module firmware via ribbon cable connection for flexibility when updating systems
- Communicate in your preferred language using the multilingual user interface
- Work reliably and efficiently on the go with power supplied by 4 AAA batteries

OPERATING SPECIFICATIONS

- Power input: 4 AAA batteries (included)
- Communications: Wireless induction, 25 mm range from decoder to EZ-DT Diagnostic Tool
- 46 mm full-colour, backlit TFT display

USER-INSTALLED OPTIONS

- Centralus™ Software with Pro-C and ICC2 Controllers
- Hydrawise™ Software with HCC and HPC Controllers
- DECSTAKE10 Universal Decoder Stake, 10-pack; [see page 144](#)

DECODER MODELS

Model	Description
EZ-DM	Decoder output module for ICC2 and HCC Controllers
PC-DM	Decoder output module for Pro-C and HPC Controllers
EZ-1	Single-station decoder with status LED
EZ-DT	EZ-DT Diagnostic Tool



EZ-DT Diagnostic Tool

Height: 197 mm
Width: 70 mm
Depth: 22 mm

EZ-DT DIAGNOSTIC TOOL



Compatible with:



HCC Controller
Page 121



ICC2 Controller
Page 128

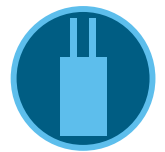

EZ Decoder System
Page 142

UNIVERSAL DECODER STAKE

The Universal Decoder Stake raises the decoder off the ground to keep two-wire installations organised, clean, and easily accessible during routine maintenance.

KEY BENEFITS

- Raises decoder off the ground, so contractors don't have to dig the device out of the mud
- Holds Hunter decoders in end-up position for convenient access and wireless programming without removal
- Works with all Hunter decoders and most other brands, so contractors only need to stock one item
- Zip ties conveniently included to secure the stake during installation
- Sturdy construction ensures the stake won't break or bend when hammered into the dirt
- Made primarily from recycled materials with minimal packaging to prevent waste and minimise carbon footprint

OPERATING SPECIFICATIONS

- Fits all Hunter decoders and most other brands
- Zip ties included
- Made of recycled materials

Universal Decoder Stake

Height: 27.5 cm



UNIVERSAL DECODER STAKE



UNIVERSAL DECODER STAKE

Model	Description
DECSTAKE10	Universal Decoder Stake (10 per carton), zip ties included

ANTENNA EXTENSION KITS

Use these flexible Antenna Extension Kits when buildings, terrain, or other obstructions prevent reliable wireless communications.

KEY BENEFITS

- Universal Antenna Extension Kit option for Wi-Fi and cellular radio communications (ANT-EXT-KIT)
 - Wi-Fi: HCC Controller, A2C-WIFI
 - Cell: A2C-CELL-E, A2C-LTEM
- For ROAM XL Remotes, extend the receiver antenna up to 7.6 m with a convenient extension cable (ROAMXL-EXT)
- Simplify Plastic Pedestal installations with a flexible pedestal lid mounting option (PED-LID-ANT-BRKT)



ANT-EXT-KIT

ANTENNA EXTENSION OPTIONS

Model	Description
ANT-EXT-KIT	Universal Antenna Extension Kit for Wi-Fi and cellular communication hardware (2.7 m cable and mounting hardware)
ROAMXL-EXT	ROAM XL Antenna Extension Kit (7.6 m cable and mounting hardware)
PED-LID-ANT-BRKT	Plastic Pedestal Antenna Mount

WATERPROOF WIRE CONNECTOR

Use this approved waterproof connector for EZ-1 Decoders and all above-grade solenoid and sensor wiring connections.

KEY BENEFITS

- 100% silicone-based sealant protects against moisture and corrosion
- Designed as a single-use only connection
- UL Listed (UL486G) to 600 V for use in damp/wet locations or above-grade applications
- Easy to apply, pre-filled twist-on wire connectors
- Eliminates the need for heat-shrink or excessive taping
- Not for use in continual submersion applications, use DBRY-6 Splice Connectors
- Approvals: UL, cUL, FCC, CE, UKCA, RCM, RoHS, ISED

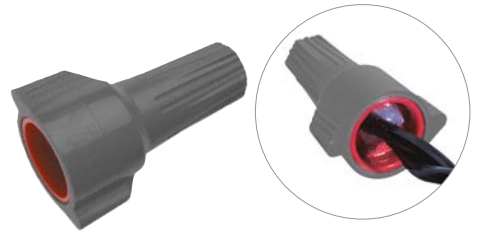

Waterproof Wire Connector

Height: 3.5 cm
 Minimum wire: 3 #0.8 mm²
 Maximum wire: 2 #6 mm² with 1 #3 mm²

WIRE CONNECTOR	
Model	Description
WC100	Bulk 100 connectors in canister

WC100 WIRE CONNECTOR



WATERPROOF SPLICE KIT

Use this approved splice kit for all direct-burial two-wire ICD and legacy DUAL™ Decoder wiring connections, as well as Pilot™ Two-Way Modules.

KEY BENEFITS

- UL Listed (UL486G) to 600 V for use in damp/wet location or direct-burial applications
- Waterproof, corrosion-proof, UV-rated, and impact resistant
- Snap-fit lid provides strain relief and three wire exits
- Prefilled with silicone that never hardens
- Two-part system includes red/yellow winged wire connector and silicone-filled tube
- Compatible with EZ-1 Decoder connections, but not a requirement
- Approvals: UL, cUL, FCC, CE, UKCA, RCM, RoHS, ISED



Waterproof Splice Kit

Height: 9.5 cm
 Minimum wire: 2-7 #0.8 mm²
 Maximum wire: 2-3 #6 mm²

DBRY-6 SPLICE KIT	
Model	Description
DBRY100	Bulk 100 connectors (100 tubes loose in box, plus inner box with 100 wire nuts)
DBRY2X25	25 x 2-packs (2 tubes and 2 wire nuts in a plastic bag x 25 units)

DBRY-6 WATERPROOF SPLICE KIT



ROAM REMOTE

Enable convenient controller management from a distance with this handheld wireless remote.

KEY BENEFITS

- Compatibility with Hunter X-Core™, X2™, Pro-C™, HPC, ICC2, HCC, ACC2, legacy ACC, and I-Core™ Controllers to enable remote management for projects of any size
- Manually start individual stations or programs for quick maintenance checks and troubleshooting
- 128 programmable addresses available prevents cross-communication between multiple remotes within close proximity of each other
- Programmable run times from 1 to 90 minutes, which will not overwrite regular automatic programming
- Manual operation up to 240 stations provides flexibility for larger projects

OPERATING SPECIFICATIONS

- Range: 300 m from transmitter to receiver
- Transmitter power source: 4 AAA batteries (included)
- Receiver power source: 24 VAC, 0.010 A
- System operating frequency: 433 MHz
- SmartPort™ Wiring Harness installation: maximum 15 m from controller
- FCC, CE, and UKCA approved for use in the United States and internationally
- Warranty period: 2 years



ROAM XL Transmitter and Receiver

Height: 18 cm
Width: 6 cm
Depth: 3 cm



SmartPort Wiring Harness

Hunter remotes require the installation of a SmartPort Wiring Harness, which is wired to the terminals on the controller and allows for quick connection to any Hunter receiver.



Wall-Mount Bracket for SmartPort Wiring Harness

P/N 258200

ROAM

Model	Description
ROAM-KIT	Transmitter, receiver, SmartPort Wiring Harness, and 4 AAA batteries included
ROAM-R	Receiver unit
ROAM-TR	Transmitter unit and 4 AAA batteries included

USER-INSTALLED OPTIONS

Model	Description
ROAM-WH	SmartPort Wiring Harness (length: 1.8 m)
ROAM-SCWH	Shielded SmartPort Wiring Harness (length: 7.6 m)
258200	Wall-mount bracket for SmartPort Wiring Harness

ROAM XL REMOTE

Add professional, licence-free remote control to projects of any size with this long-range remote.

KEY BENEFITS

- Compatibility with Hunter X-Core™, X2™, Pro-C™, HPC, ICC2, HCC, ACC2 legacy ACC, and I-Core™ Controllers to enable remote management for projects of any size
- Manually start individual stations or programs for quick maintenance checks and troubleshooting
- 128 programmable addresses available prevents cross-communication between multiple remotes within close proximity of each other
- Programmable run times from 1 to 90 minutes, which will not overwrite regular automatic programming
- Manual operation up to 240 stations provides flexibility for larger projects
- Rugged and water-resistant transmitter includes a large LCD display with simple push-button operation and a battery-life indicator

OPERATING SPECIFICATIONS

- Range: 3 km (line of sight) from transmitter to receiver
- Transmitter power source: 4 AAA batteries (included)
- Receiver power source: 24 VAC, 0.010 A
- System operating frequency: 27 MHz
- SmartPort™ Wiring Harness installation: maximum 15 m from controller
- FCC approved (not available in EU and some other countries; check local regulations)
- Warranty period: 3 years



ROAM XL Transmitter and Receiver

(without antenna)
Height: 16 cm
Width: 8 cm
Depth: 3 cm

ROAM XL	
Model	Description
ROAMXL-KIT	Transmitter, receiver, SmartPort Wiring Harness, 4 AAA batteries and plastic carrying case included
ROAMXL-R	Receiver unit (SmartPort Wiring Harness included)
ROAMXL-TR	Handheld transmitter and 4 AAA batteries included

USER-INSTALLED OPTIONS	
Model	Description
258200	Wall-mount bracket for SmartPort Wiring Harness
ROAM-WH	SmartPort Wiring Harness (length: 1.8 m)
ROAM-SCWH	Shielded SmartPort Wiring Harness (length: 7.6 m)
ROAMXL-EXT	ROAM XL Antenna Extension Kit (7.6 m cable and mounting hardware included)



SmartPort Wiring Harness

Hunter remotes require the installation of a SmartPort Wiring Harness, which is wired to the terminals on the controller and allows for quick connection to any Hunter receiver.



Wall-Mount Bracket for SmartPort Wiring Harness

P/N 258200

PSR

This reliable and economical Pump Start Relay family is perfect for systems that require pump activation.

KEY BENEFITS

- Pump Start Relay family for a variety of voltage and power requirements
- 24 VAC flying leads make connection to the controller quick and easy
- Suitable for conventional wiring or two-wire decoder activation

OPERATING SPECIFICATIONS

- Recommended installation: Minimum 4.5 m from irrigation controller; see chart on **page 221** for maximum distances
- Approvals: IP44 (outdoor), UL, cUL, FCC, CE, RCM, ISED
- Warranty period: 2 years



Pump Start Relay

Height: 17 cm
Width: 19 cm
Depth: 12 cm

PUMP START RELAY

Model	Description
PSR-22	Double-pole/single-throw Pump Start Relay for 120 VAC pumps up to 1.5 kW or 230 VAC pumps up to 2.2 kW
PSR-52	Double-pole/single-throw Pump Start Relay for 120 VAC pumps up to 2.2 kW or 230 VAC pumps up to 5.6 kW
PSR-53	Triple-pole/single-throw Pump Start Relay for 120 VAC pumps up to 2.2 kW, 230 VAC pumps up to 5.6 kW, or 230 VAC pumps up to 7.5 kW (3-phase)

PUMP START RELAY ELECTRICAL SPECIFICATIONS

Model	Single-Phase		3-Phase**	Max. Full Load	Max. Resistive	Coil VA							
	kW AT 120 VAC	kW AT 230 VAC				kW AT 230 VAC	INRUSH		HOLDING				
			AMPS	AMPS	50 Hz		60 Hz	50 Hz	60 Hz	50 Hz	60 Hz		
PSR-22	1.5*	2.2*	N/A	30	40	33	30	1.38	1.25	8	6.5	0.33	0.27
PSR-52	2.2	5.6	N/A	40	50	65	60	2.71	2.50	7.5	5	0.31	0.21
PSR-53	2.2	5.6	7.5	40	50	65	60	2.71	2.50	7.5	5	0.31	0.21

Note: *Approximate power

** 3-phase power at 230 VAC is not commonly available in some international markets. Check local electrical codes for compatibility.

PSR-B

For distant pump starts that require more power, choose the PSR-B.

KEY BENEFITS

- Provides a solution for pump start relay installations that have insufficient power to activate the pump
- Includes solid state relay and local 24 VAC transformer for simple PSR activation

OPERATING SPECIFICATIONS

- Primary AC power input: 120/230 VAC,
- Secondary AC power output: 24 VAC, 1.6 A
- Relay rating: Double-pole, double-throw solid state (10 A)
- Approvals: IP54 (outdoor), UL, cUL, FCC, CE, RCM, ISED
- Warranty period: 2 years

PUMP START RELAY BOOSTER

Model	Description
PSR-B	Pump Start Relay Booster for increasing controller output power



PSR-B Pump Start Relay Booster

Height: 22 cm
Width: 18 cm
Depth: 9.5 cm

CONNECT YOUR WAY

Choose from a range of Wi-Fi, LAN (Ethernet), and cellular connection accessories to enable remote irrigation management on standalone controllers anytime, anywhere.

HYDRAWISE™ SOFTWARE

X2 Controller with WAND Module Installed



WAND
Wi-Fi accessory for X2 Controllers, managed by Hydrawise Software
page 118

CENTRALUS™ SOFTWARE

PRO-C Controller with PC-WIFI Module Installed



PC-WIFI
Wi-Fi accessory for Pro-C Controllers, managed by Centralus Software
page 124

CENTRALUS SOFTWARE

ICC2 Controller with LANKIT Module Installed

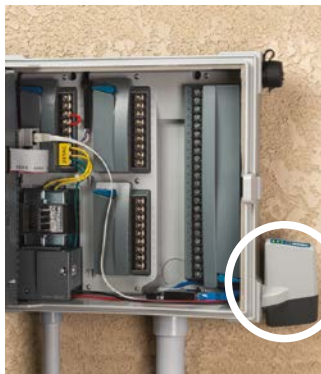

WIFIKIT
Wi-Fi accessory for ICC2 Controllers, managed by Centralus Software
page 124



LANKIT
Ethernet accessory for ICC2 Controllers, managed by Centralus Software
page 124



CELLKIT
Cellular accessory for ICC2 Controllers, managed by Centralus Software
page 124

CENTRALUS SOFTWARE

ACC2 Controller with A2C-LTEM Module Installed



A2C-WIFI
Wi-Fi accessory for ACC2 Controllers, managed by Centralus Software
page 127



A2C-LAN
Ethernet accessory for ACC2 Controllers, managed by Centralus Software
page 127



A2C-LTEM
Cellular accessory for ACC2 Controllers, managed by Centralus Software
page 127

SENSORS

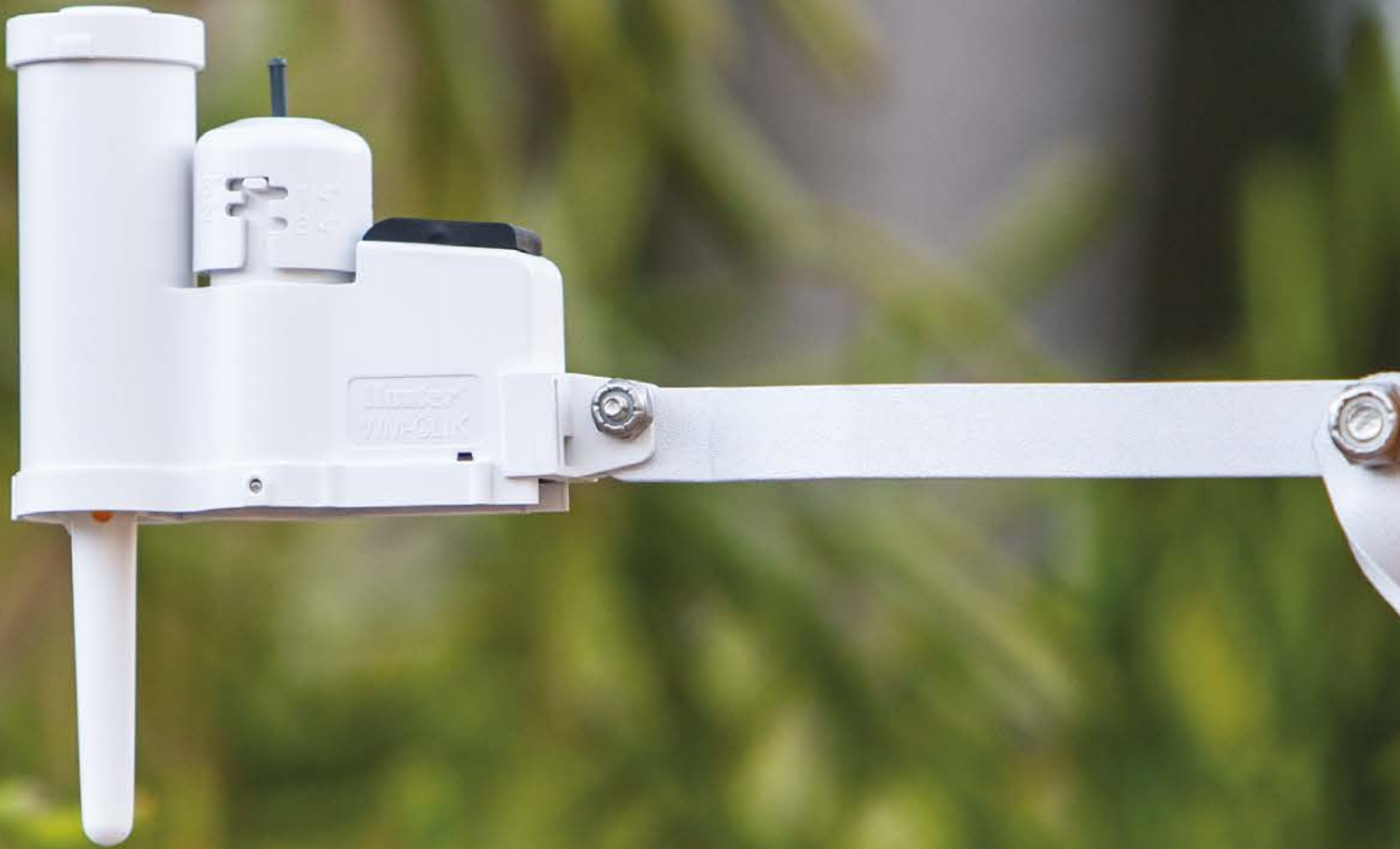

SENSOR AND CONTROLLER COMPATIBILITY CHART

AC CONTROLLERS	SENSOR INPUTS	RAIN	SMART WEATHER ADJUST	FLOW*	HIGH-FLOW SHUTOFF
ECO LOGIC page 110	1	Mini-Clik, Rain-Clik	N/A	N/A	Flow-Clik
X-CORE™ page 111	1	Mini-Clik, Rain-Clik	Solar Sync	N/A	Flow-Clik
HC page 116	2	Mini-Clik, Rain-Clik	Hydrawise™ Software	HC Flow Meter	HC Flow Meter
X2™ page 117	1	Mini-Clik, Rain-Clik	Hydrawise Software	N/A	Flow-Clik
PRO-HC page 119	2	Mini-Clik, Rain-Clik	Hydrawise Software	HC Flow Meter	HC Flow Meter
HPC page 120	2	Mini-Clik, Rain-Clik	Hydrawise Software	HC Flow Meter	HC Flow Meter
HCC page 121	2	Mini-Clik, Rain-Clik	Hydrawise Software	HC Flow Meter	HC Flow Meter
ACC2 page 126	1 Solar Sync, 3 Clik, 6 Flow	Mini-Clik, Rain-Clik	Solar Sync, Centralus™ Software	HFS, WFS, HC Flow Meter, Other (K-Factor or Scaled Pulse)	Built-In, Real-Time Flow Monitoring and Management
ICC2 page 128	2	Mini-Clik, Rain-Clik	Solar Sync, Centralus Software	HFS, WFS, HC Flow Meter, Other (K-Factor or Scaled Pulse)	Flow-Clik
PRO-C™ page 130	2	Mini-Clik, Rain-Clik	Solar Sync, Centralus Software	HFS, WFS, HC Flow Meter, Other (K-Factor or Scaled Pulse)	Flow-Clik
BATTERY-OPERATED CONTROLLERS					
NODE page 135	1	Mini-Clik, Rain-Clik	N/A	N/A	N/A
NODE-BT page 136	2	Mini-Clik, Rain-Clik	N/A	N/A	N/A
XC HYBRID page 137	1	Mini-Clik, Rain-Clik	N/A	N/A	N/A

*Centralus communication module required for flow sensor input with Pro-C and ICC2 Controllers

SOIL MOISTURE	FREEZE	WIND
Soil-Clik	Freeze-Clik, WR-Clik	Wind-Clik, MWS
Soil-Clik	Freeze-Clik, WR-Clik	Wind-Clik, MWS
Soil-Clik	Freeze-Clik, WR-Clik, Hydrawise Software	Wind-Clik, MWS, Hydrawise Software
Soil-Clik	Freeze-Clik, WR-Clik, Hydrawise Software	Wind-Clik, MWS, Hydrawise Software
Soil-Clik	Freeze-Clik, WR-Clik, Hydrawise Software	Wind-Clik, MWS, Hydrawise Software
Soil-Clik	Freeze-Clik, WR-Clik, Hydrawise Software	Wind-Clik, MWS, Hydrawise Software
Soil-Clik	Freeze-Clik, WR-Clik, Hydrawise Software	Wind-Clik, MWS, Hydrawise Software
Soil-Clik	Freeze-Clik, WR-Clik, Centralus Software	Wind-Clik, MWS
Soil-Clik	Freeze-Clik, WR-Clik, Centralus Software	Wind-Clik, MWS
Soil-Clik	Freeze-Clik, WR-Clik, Centralus Software	Wind-Clik, MWS
N/A	Freeze-Clik	N/A
SC-Probe	Freeze-Clik	N/A
N/A	Freeze-Clik	N/A



Rain-Clik™ Sensor



Mini-Clik™ Sensor



Soil-Clik™ Sensor



Freeze-Clik™ Sensor



Wind-Clik™ Sensor



Mini Weather Station



Solar Sync™ Sensor



Flow-Sync™ Sensor



HC Flow Meter Sensor
Available wireless!



Wireless Flow Sensor



Flow-Clik™ Sensor

RAIN-CLIK™

To prevent water waste, built-in Quick Response™ Technology instantly shuts down irrigation as soon as it starts raining.

Sensor: Rain, Freeze

KEY BENEFITS

- Quick Response Technology triggers instant rain shutoff
- Freeze sensing model halts system operation at 3°C
- Wireless sensor kit simplifies installation
- Maintenance-free design with integrated battery for wireless models
- Adjustable vent ring allows for shorter or longer reset period
- Includes gutter bracket and wall mount with wireless models
- Compatible with most normally open or normally closed irrigation controllers

OPERATING SPECIFICATIONS

- Quick Response Technology:
 - Time to turn off irrigation system: approximately 2 to 5 minutes for Quick Response
 - Time to reset Quick Response: approximately 4 hours under dry, sunny conditions
 - Time to reset when fully wet: approximately 3 days under dry, sunny conditions
- All models switch rating (24 VAC): 3 A
- Wired models include 7 m of 0.5 mm² sheathed, UL-approved wire
- Wireless model operating frequency: 433 MHz
- Wireless model range is 243 m line of sight from sensor to receiver
- Multiple wireless receivers can be operated from a single wireless sensor
- Approvals: UL, cUL, FCC, CE, UKCA, RCM
- Warranty period: 5 years

USER-INSTALLED OPTIONS

- Optional Gutter Mount for wired models (included with WR-CLIK)
- Vandal-resistant Wireless Sensor Guard for surface- or pole-mounting (order sensor separately)
- Vandal-resistant Wireless Receiver Guard for pedestal mounting (order receiver separately)



Wired Rain-Clík Sensor
(with mounting arm)
Height: 6 cm
Length: 18 cm
Width: 2.5 cm



Sensor Gutter Mount
Height: 1.2 cm
Length: 7.6 cm
Width: 1.2 cm



Wireless Rain-Clík Sensor
(with mounting arm)
Height: 7.6 cm
Length: 20 cm
Width: 2.5 cm



Wireless Receiver
(with wall-mounting hardware)
Height: 8 cm
Length: 10 cm
Width: 3 cm



Wireless Sensor Guard
(with mounting hardware)
Height: 7 cm
Length: 9.5 cm
Width: 3.2 cm



Wireless Receiver Guard
(with mounting hardware)
Height: 12.7 cm
Length: 10.2 cm
Width: 3.2 cm

RAIN-CLIK	
Model	Description
RAIN-CLIK	Wired Rain-Clík Sensor
RAIN-CLIK-NO	Wired Rain-Clík Sensor, normally open switch
RFC	Wired Rain/Freeze-Clík Sensor
WR-CLIK	Wireless Rain/Freeze-Clík Sensor, Receiver, and Gutter Mount
WS-GUARD	Vandal-resistant Wireless Sensor Guard for surface- or pole-mounting
WR-GUARD	Vandal-resistant Wireless Receiver Guard for pedestal mounting

Compatible with:



Waterproof Wire Connector
Page 145



Smart WaterMark
Recognised as a responsible water-saving tool

MINI-CLIK™

This sensor halts scheduled irrigation when it detects a preset level of rainfall to prevent water waste.

Sensor: Rain, Freeze

KEY BENEFITS

- Shuts off irrigation automatically when the sensor detects rainfall from 3 mm to 19 mm
- Debris-tolerant for reliable operation and no unnecessary shutdowns
- Wireless sensor kit simplifies installation*
- Quick Response™ Technology triggers faster system shutdown for plant protection*
- Built-in freeze sensing halts system operation at 3°C to protect plants and keep roads and walkways ice-free*
- Maintenance-free design with integrated battery for wireless models
- Compatible with most normally open or normally closed irrigation controllers

OPERATING SPECIFICATIONS

- Quick Response Technology* (when enabled):
 - Time to turn off irrigation system: approximately 2 to 5 minutes
 - Time to reset: approximately 4 hours under dry, sunny conditions
 - Time to reset when fully wet: approximately 3 days under dry, sunny conditions
- All models switch rating (24 VAC): 3 A
- Wired models include 7 m of 0.5 mm² sheathed, UL-approved wire
- Wireless model operating frequency: 433 MHz
- Wireless model range is 243 m line of sight from sensor to receiver
- Multiple wireless receivers can be operated from a single wireless sensor
- Approvals: UL, cUL, FCC, CE, UKCA, RCM
- Warranty period: 5 years

USER-INSTALLED OPTIONS

- Optional Gutter Mount for wired models (included with WM-CLIK)
- Vandal-resistant Wireless Sensor Guard for surface- or pole-mounting (order sensor separately)
- Vandal-resistant Wireless Receiver Guard for pedestal mounting (order receiver separately)

*Wireless Mini-Clik Sensor only

MINI-CLIK	
Model	Description
MINI-CLIK	Mini-Clik Sensor
MINI-CLIK-NO	Mini-Clik Sensor, normally open switch
MINI-CLIK-C	Mini-Clik Sensor, conduit mount
SG-MC	Mini-Clik Sensor in a stainless steel sensor enclosure
WM-CLIK	Wireless Mini-Clik Sensor, Receiver, and Gutter Mount
WS-GUARD	Vandal-resistant Wireless Sensor Guard for surface- or pole-mounting
WR-GUARD	Vandal-resistant Wireless Receiver Guard for pedestal mounting



Wired Mini-Clik Sensor
(with mounting arm)
Height: 5 cm
Length: 15 cm
Width: 2.5 cm



Wired Mini-Clik Sensor
(with stainless steel enclosure)
Height: 13.9 cm
Length: 7.6 cm
Width: 10.1 cm



Wireless Mini-Clik Sensor
(with mounting arm)
Height: 7.6 cm
Length: 20 cm
Width: 2.5 cm



Wireless Receiver
(with wall-mounting hardware)
Height: 10 cm
Length: 8 cm
Width: 3 cm



Wireless Sensor Guard
(with mounting hardware)
Height: 7 cm
Length: 9.5 cm
Width: 3.2 cm



Wireless Receiver Guard
(with mounting hardware)
Height: 12.7 cm
Length: 10.2 cm
Width: 3.2 cm

Compatible with:



Waterproof Wire Connector
Page 145



Smart WaterMark
Recognised as a responsible water-saving tool (WM-CLIK only)

SOLAR SYNC™

Sensor: **ET, Rain, Freeze**

This sensor automatically adjusts controller run times daily based on local climate conditions to reduce water usage and improve plant health.

KEY BENEFITS

- Automatically adjusts irrigation run times based on weather conditions using on-site solar radiation and air temperature
- Quick Response™ Technology triggers instant rain shutoff
- Freeze sensing halts system operation at 3°C
- Wireless sensor kit simplifies installation
- Maintenance-free design with integrated battery for wireless models
- Adjustable vent ring allows for shorter or longer reset period
- Use with X-Core™, Pro-C™, ICC2, ACC2, and legacy ACC and I-Core™ Controllers
- Manage remotely with Centralus™ Software for Pro-C, ICC2, and ACC2 installations

OPERATING SPECIFICATIONS

- Solar Sync Technology:
 - Adjusts run times daily 3 minutes before midnight using the last 3 days of ET (evapotranspiration) data
- Quick Response Technology:
 - Time to turn off irrigation system: approximately 2 to 5 minutes for Quick Response
 - Time to reset Quick Response: approximately 4 hours under dry, sunny conditions
 - Time to reset when fully wet: approximately 3 days under dry, sunny conditions
- All models switch rating (24 VAC): 3 A
- Wired models include 7 m of 0.5 mm² sheathed, UL-approved wire
- Wireless model operating frequency: 433 MHz
- Wireless model range is 243 m line of sight from sensor to receiver
- Multiple wireless receivers can be operated from a single wireless sensor
- Approvals: UL, cUL, FCC, CE, UKCA, RCM, SASO Quality Mark Certified*
- Warranty period: 5 years

USER-INSTALLED OPTIONS

- Vandal-resistant Wireless Sensor Guard for surface- or pole-mounting (order sensor separately)
- Vandal-resistant Wireless Receiver Guard for pedestal mounting (order receiver separately)

SOLAR SYNC	
Model	Description
SOLAR-SYNC-SEN*	Wired Solar Sync Sensor and Gutter Mount
WSS-SEN*	Wireless Solar Sync Sensor, Receiver, and Gutter Mount
WS-GUARD	Vandal-resistant Wireless Sensor Guard for surface- or pole-mounting
WR-GUARD	Vandal-resistant Wireless Receiver Guard for pedestal mounting



Wired Solar Sync Sensor
(with mounting arm)
Height: 8 cm
Length: 22 cm
Width: 2 cm



Wireless Solar Sync Sensor
(with mounting arm)
Height: 11 cm
Length: 22 cm
Width: 2.5 cm



Wireless Solar Sync Receiver
(with wall-mounting kit)
Height: 14 cm
Length: 4 cm
Width: 4 cm



Wireless Sensor Guard
(with mounting hardware)
Height: 7 cm
Length: 9.5 cm
Width: 3.2 cm



Wireless Receiver Guard
(with mounting hardware)
Height: 12.7 cm
Length: 10.2 cm
Width: 3.2 cm

Compatible with:



Centralus Software
Page 124



Waterproof Wire Connector
Page 145



Smart WaterMark
Recognised as a responsible water-saving tool

SOIL-CLIK™

Sensor: **Soil Moisture**

This sensor prevents water waste by measuring soil moisture and shutting off irrigation when a pre-set level is reached.

KEY BENEFITS

- View current soil moisture level and status at a glance
- One-touch override allows soil moisture bypass for special conditions
- Low-voltage outdoor enclosure powered by host controller
- Connect to Hunter sensor inputs, or use to interrupt common wires in virtually any 24 VAC irrigation system
- Use with Solar Sync™ Sensor for maximum water savings; see page 156

OPERATING SPECIFICATIONS

- Switch rating (24 VAC): 5 A
- Input power (24 VAC): 100 mA
- Normally closed dry-contact closure
- 2 m maximum distance from Soil-Clik module to controller
- 300 m maximum distance from Soil-Clik module to sensor probe for AC installations
- 30 m maximum distance for NODE-BT installations
- Sensor probe includes 80 cm of direct-burial wire
- Approvals: UL, cUL, FCC, CE, UKCA, RCM
- Warranty period: 5 years

Soil-Clik Module

Height: 11.4 cm
Width: 8.9 cm
Length: 3.2 cm



Soil-Clik Probe

Height: 8.3 cm
Diameter: 2 cm



SENSORS

SOIL-CLIK	
Model	Description
SOIL-CLIK	Soil-Clik moisture sensor module and probe
SC-PROBE	Soil moisture probe sensor for NODE-BT (module is not used)

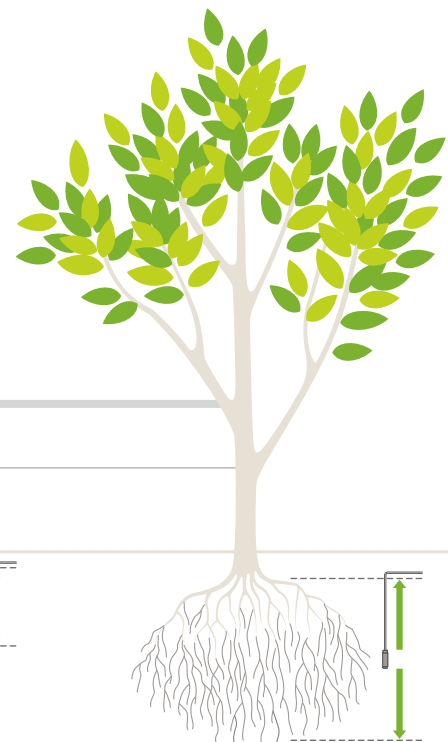

Probe installed in root zone to monitor soil moisture

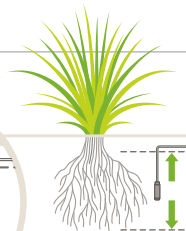
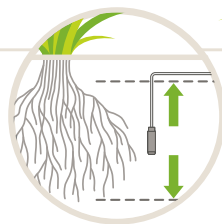
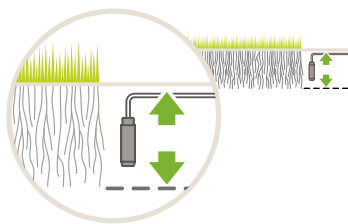

Compatible with:



Waterproof Wire Connector
Page 145



NODE-BT Controller
Page 136

In turf applications, the probe should be placed in the root zone, approximately 15 cm deep (adjust for actual turf conditions).

For shrubs or trees, select a deeper depth that matches the root zone. For new plantings, choose a spot halfway down the root ball, adjacent to native soil.

HC FLOW METER

Sensor: **Flow**

Detect, monitor, and report critical flow zone data via wired or wireless connection with this robust and simple-to-install flow sensor.

KEY BENEFITS

- Compatible with Hydrowise™ enabled HC, HPC, Pro-HC, and HCC Controllers as well as Centralus enabled Pro-C, ICC2, and ACC2 Controllers
- Provides station-level flow rates and totals
- Sends automatic alerts in the event of high-flow, low-flow, or unscheduled flow conditions
- Flow reports within Hydrowise Software can display total system water use and individual station water use for accurate water budgeting and tracking
- Robust brass construction with union fittings for easy installation and removal for winterisation
- Analogue dial on the face of the meter displays daily flow totals

OPERATING SPECIFICATIONS

- Scaled pulse output is precalibrated based on the size of the meter
- When wired directly to the controller, the meter must be installed with shielded, minimum 0.75 mm² wire, up to 300 m from the controller
- Accuracy: ± 2% of reading at recommended flow
- Warranty period: 2 years

WIRELESS HC FLOW METER BENEFITS

- Add wireless communication to any HC Flow Meter (sensor sold separately)
- Send flow data wirelessly from the sensor to the controller, without the need to run wire or dig trenches



HC-075-FLOW-B

(20 mm male BSP thread)
Height: 8 cm
Length: 23.2 cm
Depth: 8 cm
Weight: 0.9 kg

HC-150-FLOW-B

(40 mm male BSP thread)
Height: 16.2 cm
Length: 43.1 cm
Depth: 12.5 cm
Weight: 6.6 kg

HC-100-FLOW-B

(25 mm male BSP thread)
Height: 9.3 cm
Length: 26.2 cm
Depth: 8 cm
Weight: 1.4 kg

HC-200-FLOW-B

(50 mm male BSP thread)
Height: 16.2 cm
Length: 44.7 cm
Depth: 12.5 cm
Weight: 7.4 kg

HC FLOW METER MODELS

Model	Description
W-HC-FLOW-INT	Wireless HC Flow Meter Kit, includes transmitter and receiver (international 868 MHz)
W-HC-FLOW-AU	Wireless HC Flow Meter Kit, includes transmitter and receiver (AU/NZ 915 MHz)
HC-075-FLOW-B	HC Flow Meter with 20 mm male BSP thread, m ³ reading
HC-100-FLOW-B	HC Flow Meter with 25 mm male BSP thread, m ³ reading
HC-150-FLOW-B	HC Flow Meter with 40 mm male BSP thread, m ³ reading
HC-200-FLOW-B	HC Flow Meter with 50 mm male BSP thread, m ³ reading

WIRELESS HC FLOW METER



HC FLOW METER SPECIFICATIONS				
	HC-075-FLOW-B (20 mm)	HC-100-FLOW-B (25 mm)	HC-150-FLOW-B (40 mm)	HC-200-FLOW-B (50 mm)
Minimum flow (l/min)	0.83	1.16	3.33	7.5
Maximum recommended flow (l/min)	60	110	250	400
Maximum flow (l/min)	80	130	330	500
Dial reading (m ³)	1 pulse per 1 litre	1 pulse per 10 litres	1 pulse per 10 litres	1 pulse per 10 litres

WIRELESS HC FLOW METER OPERATING SPECIFICATIONS

- 152 m range (line of sight) from transmitter to receiver
- Communication frequency: 868 MHz for international use; 915 MHz for use in Australia/New Zealand
- Transmitter power supply: 3 AA batteries
- Receiver power supply: 24 VAC from host controller
- Warranty period: 2 years

HC FLOW METER PRESSURE LOSS CHART

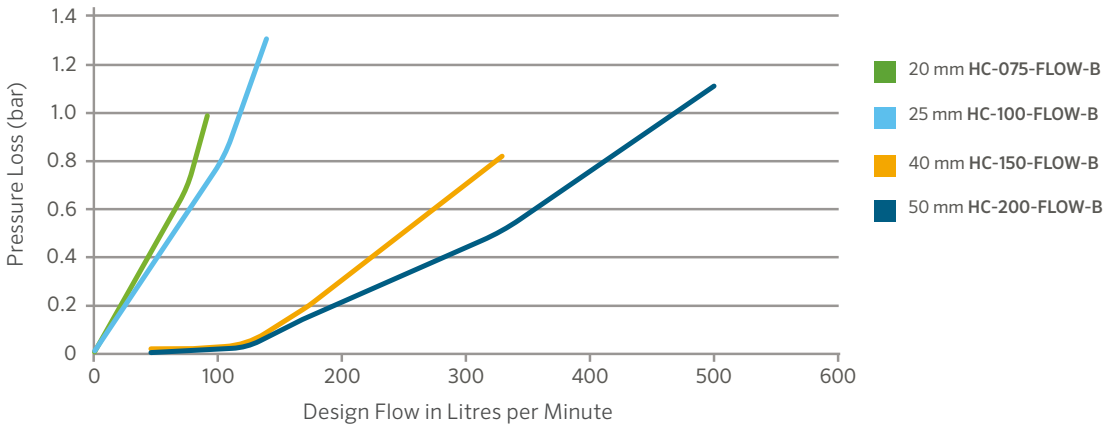

FLOW-CLIK™

Sensor: **Flow**

Add high-flow shutoff capabilities to any irrigation controller with this simple, adjustable device.

KEY BENEFITS

- Automatically shuts down entire system if an overflow condition occurs, helping to protect against flood damage and erosion
- Single-button calibration to set highest flow rate
- User-adjustable timing and delay for sensor response
- Compatible with all Hunter AC-powered controllers for a variety of applications
- Multi-colour LED indicates system status and if flow is within limits

OPERATING SPECIFICATIONS

- Recommended pressure range: 1.5 to 15.0 bar; 150 to 1,500 kPa
- Current draw (24 VAC): 0.025 A
- Switching current: 2 A maximum
- Sensor wiring: 2 x direct burial, 0.75 mm² or greater, colour-coded or marked for polarity, up to 300 m from the interface module
- Programmable start up delay: 0 to 300 seconds (allows for system hydraulics to stabilise and prevents false flow readings)
- Programmable interrupt period: 5 to 60 minutes (or option to reset manually)
- Warranty period: 5 years

USER-INSTALLED OPTIONS

- FCT fittings for 25 mm to 100 mm pipe diameters



Flow-Click Sensor and Module shown with required FCT fitting for pipe installation (sold separately)

Compatible with:



Waterproof Wire Connector
Page 145

FLOW-CLIK

Model	Description
FLOW-CLIK	Standard kit for all 24 VAC controllers. <i>Includes sensor and interface module, sensor requires FCT for pipe installation.</i>

REQUIRED USER-INSTALLED OPTION (SPECIFY SEPARATELY)

Model	Description
FCT-100	1" (25 mm) Schedule 40 sensor receptacle tee
FCT-150	1½" (40 mm) Schedule 40 sensor receptacle tee
FCT-158	1½" (40 mm) Schedule 80 sensor receptacle tee
FCT-200	2" (50 mm) Schedule 40 sensor receptacle tee
FCT-208	2" (50 mm) Schedule 80 sensor receptacle tee
FCT-300	3" (80 mm) Schedule 40 sensor receptacle tee
FCT-308	3" (80 mm) Schedule 80 sensor receptacle tee
FCT-400	4" (100 mm) Schedule 40 sensor receptacle tee

BSP ADAPTERS FOR FCT FITTINGS

Diameter	Model
1" (25 mm)	795700
1½" (40 mm)	795800
2" (50 mm)	241400
3" (80 mm)	477800

FLOW RANGE

Pipe Diameter	Operating Range			
	Minimum		Suggested Maximum*	
	l/min	m ³ /hr	l/min	m ³ /hr
1" (25 mm)	7.6	0.45	64	3.84
1½" (40 mm)	19	1.14	132	8.0
2" (50 mm)	37.8	2.26	208	12.5
3" (80 mm)	106	6.36	450	27.0
4" (100 mm)	129	7.74	750	45.0

Notes:

* Good design practice dictates the maximum velocity not to exceed 1.5 m/sec. Suggested maximum velocity is based upon Class 200 IPS plastic pipe.

FLOW-SYNC™

Sensor: **Flow**

This cost-effective flow sensor is designed for use with commercial controllers.

KEY BENEFITS

- Simple-insertion flow sensor for metering and reacting to real-time flow conditions
- Provides station-level flow monitoring for reaction to high- or low-flow conditions, helping to protect against flood damage and erosion
- Compatible with Hunter ACC2 and legacy ACC and I-Core™ Controllers, ICD-SEN Sensor Decoders, Pro-C and ICC2 Centralus Communication Modules
- Easy connection up to 300 m from controller or sensor decoder
- Sensor is precalibrated for K-Factor and Offset based on pipe size, allowing for quick setup and programming within the controller

OPERATING SPECIFICATIONS

- Recommended pressure range: 1.5 to 15.0 bar; 150 to 1,500 kPa
- Pressure loss: < 0.009 bar; 0.9 kPa
- Sensor wiring: 2 x direct burial, 0.75 mm² or greater, colour-coded or marked for polarity, up to 300 m from controller
- Warranty period: 5 years



Impeller-type flow meter, requires FCT fitting for pipe installation (order separately)

Compatible with:



**ACC2
Controllers**
Page 126

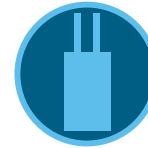

**ICD-SEN
Decoder**
Page 141



**Waterproof Wire
Connector**
Page 145

SENSORS

FLOW-SYNC	
Model	Description
HFS	Hunter Flow-Sync Sensor for use with ACC2 and legacy ACC and I-Core Controllers, ICD-SEN Sensor Decoders, and Pro-C™ and ICC2 Centralus™ Communication Modules

REQUIRED USER-INSTALLED OPTION (SPECIFY SEPARATELY)	
Model	Description
FCT-100	1" (25 mm) Schedule 40 sensor receptacle tee
FCT-150	1½" (40 mm) Schedule 40 sensor receptacle tee
FCT-158	1½" (40 mm) Schedule 80 sensor receptacle tee
FCT-200	2" (50 mm) Schedule 40 sensor receptacle tee
FCT-208	2" (50 mm) Schedule 80 sensor receptacle tee
FCT-300	3" (80 mm) Schedule 40 sensor receptacle tee
FCT-308	3" (80 mm) Schedule 80 sensor receptacle tee
FCT-400	4" (100 mm) Schedule 40 sensor receptacle tee

BSP ADAPTERS FOR FCT FITTINGS	
Diameter	Model
1" (25 mm)	795700
1½" (40 mm)	795800
2" (50 mm)	241400
3" (80 mm)	477800

FLOW RANGE				
Pipe Diameter	Operating Range			
	Minimum l/min	Minimum m ³ /hr	Suggested Maximum* l/min	Suggested Maximum* m ³ /hr
1" (25 mm)	7.6	0.45	64	3.84
1½" (40 mm)	19	1.14	132	8.0
2" (50 mm)	37.8	2.26	208	12.5
3" (80 mm)	106	6.36	450	27.0
4" (100 mm)	129	7.74	750	45.0

Notes:

* Good design practice dictates the maximum velocity not to exceed 1.5 m/sec. Suggested maximum velocity is based upon Class 200 IPS plastic pipe.

WFS

Use this sensor to retrofit flow to existing systems that cross under asphalt, concrete, or other hardscapes.

KEY BENEFITS

- Wireless flow sensor saves time, materials, and labour
- Simple-insertion flow sensor for monitoring and reacting to real-time flow conditions
- Provides station-level flow monitoring for reaction to high- or low-flow conditions, helping to protect against waste and damage from leaks
- Compatible with Hunter ACC2 and legacy ACC and I-Core™ Controllers as well as Pro-C™ and ICC2 Centralus™ Communication Modules for installation flexibility in a variety of settings
- Sensor is pre-calibrated for K-Factor and Offset based on pipe size, allowing for quick setup and programming within the controller
- Multi-colour LED on the receiver indicates proper communication to the transmitter, as well as remaining battery life

OPERATING SPECIFICATIONS

- Recommended pressure range: 0 to 15.0 bar; 0 to 1,500 kPa
- Pressure loss: < 0.009 bar; 0.9 kPa
- Maximum distance sensor to receiver: 152 m
- Operating frequency: 868 MHz
- FCC and CE approved
- Warranty period: 5 years

USER-INSTALLED OPTIONS

- FCT tee fittings for pipe installation

Sensor: **Flow**



WFS

Compatible with:



ACC2
Controllers
Page 126

WIRELESS FLOW SENSOR

Model	Description
WFS-INT	Wireless Flow Sensor Kit (international 868 MHz)
WFS-T-INT	Wireless Flow Sensor Kit transmitter only (international 868 MHz)
WFS-R-INT	Wireless Flow Sensor Kit receiver only (international 868 MHz)
WFS-ALKBATT	Wireless Flow Sensor alkaline battery with cage

FLOW RANGE

Wireless Flow Sensor Diameter	Operating Range			
	Minimum l/min	Minimum m ³ /hr	Suggested Max* l/min	Suggested Max* m ³ /hr
1" (25 mm)	7.6	0.45	64	3.84
1½" (40 mm)	19	1.14	132	8.0
2" (50 mm)	37.8	2.26	208	12.5
3" (80 mm)	106	6.36	450	27.0
4" (100 mm)	129	7.74	750	45.0

Notes:

* Good design practice dictates the maximum velocity not to exceed 1.5 m/sec. Suggested maximum velocity is based upon Class 200 IPS plastic pipe.

REQUIRED USER-INSTALLED OPTION (SPECIFY SEPARATELY)

Model	Description
FCT-100	1" (25 mm) Schedule 40 sensor (white) receptacle tee
FCT-150	1½" (40 mm) Schedule 40 sensor (white) receptacle tee
FCT-158	1½" (40 mm) Schedule 80 sensor (grey) receptacle tee
FCT-200	2" (50 mm) Schedule 40 sensor (white) receptacle tee
FCT-208	2" (50 mm) Schedule 80 sensor (grey) receptacle tee
FCT-300	3" (80 mm) Schedule 40 sensor (white) receptacle tee
FCT-308	3" (80 mm) Schedule 80 sensor (grey) receptacle tee
FCT-400	4" (100 mm) Schedule 40 sensor (white) receptacle tee





WORK SMARTER, NOT HARDER ABOVE AND BELOW

Use the Solar Sync Sensor with the Soil-Clik Sensor to measure both climate and soil conditions. Solar Sync uses ET to adjust application amounts when irrigation is needed. Soil-Clik prevents watering when proper soil moisture levels have been reached. Together, they're the ultimate environmentally responsive solution.

Solar Sync™ Sensor Above

- **Water-Saving:** Automatically adjusts run times based on local weather conditions
- **Responsive:** Shuts down irrigation during rainfall and freezing conditions
- **Convenient:** Wired or wireless models available

Soil-Clik™ Sensor Below

- **Water-Saving:** Measures soil moisture and prevents unnecessary irrigation
- **Easy:** Simple installation, push-button operation
- **Flexible:** Use with any Hunter AC-powered controller and most other brands



MICRO

MICRO IRRIGATION SOLUTIONS

From ultra-durable Hunter Dripline to our innovative Root Zone Watering System, Hunter's micro irrigation solutions are designed to apply water efficiently and precisely where it's needed. Choose the combination of products best suited for your application and plant type using the chart below.

COMMON MICRO APPLICATIONS GUIDE		
APPLICATION	STANDARD DESIGN	ADVANCED DESIGN
TREES 	MLD, Emitters, Micro Sprays, HDL	HDL-COP, PLD, Eco-Wrap™, IH Risers, RZWS
MIXED PLANTINGS 	MLD, Micro Sprays, HDL, PLD, Single-Port Emitters	HDL-COP, Multi-Port Emitters, Eco-Wrap
SLOPED AREAS 	MLD, Micro Sprays, HDL-PC, HDL-R, Emitters, RZB	HDL-CV, Eco-Mat™, Eco-Wrap, HDL-COP, IH Risers, RZWS
TURF 	HDL-COP	Eco-Wrap, Eco-Mat
SUBSURFACE 	HDL-COP	Eco-Wrap, Eco-Mat
SPARSE PLANTING 	Emitters	IH Risers
DENSE PLANTING 	Micro Sprays, HDL, PLD	HDL-COP, Eco-Wrap, Eco-Mat
GREEN ROOFS 	Eco-Mat, Eco-Wrap	Eco-Mat, Eco-Wrap
POTTED PLANTS 	Single-Port Emitters, Micro Sprays	MLD
RECLAIMED 	MLD, Micro Sprays, Emitters	HDL-R, IH Risers, RZWS

CONTROL ZONE KITS

ADVANCED FEATURES

PCZ



TOP FEATURES

PCZ

PREASSEMBLED FOR TIME SAVINGS	●
ABOVE-GROUND INSTALLATION	
FILTER SENTRY™ MECHANISM	
ROBUST, STAINLESS STEEL SCREEN	●
TOP-RATED SENNINGER™ REGULATOR	●
VALVES 100% WATER-TESTED	●
REGULATORS 100% WATER-TESTED	●
LOW FRICTION LOSS	●
RECLAIMED COMPONENTS	●
CAPABILITY OF DISC FILTRATION	
HIGHEST FLOW OPTION (100 GPM)	
FLOW CONTROL	●
APPLICATION	Residential
WARRANTY	2 Years

TOTAL RELIABILITY

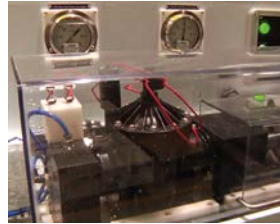

Every Hunter valve is water-tested to verify reliability, durability, and performance.

DURABLE FILTER



All Hunter filters offer a stainless steel screen and low pressure loss. 1½" (38 mm) and 2" (50 mm) filter bodies offer sizes of 80-mesh (180-microns), 120 mesh (125-microns), and 150 mesh (100-microns) with a 120-mesh (125-micron) disc filter.

ULTIMATE CONVENIENCE



Kits are preassembled to save time and labour in the field. With a highly compact design, they maximise space in the valve box.

PRECISE REGULATION



Senninger regulators are the most trusted regulators in the industry. Each regulator is water-tested before leaving the factory to ensure years of life in the field.

PCZ

Make installations quick and easy using this robust, preassembled kit with stainless steel filtration and pressure regulation.

KEY BENEFITS

- Factory-assembled for quick and easy installation
- Valves 100% water-tested to ensure dependable operation
- Senninger regulator provides precise regulation to protect system from high pressure
- 150 mesh (100 microns) stainless steel screen for years of reliable filtration

USER-INSTALLED OPTIONS

- Reclaimed water ID handle for PCZ-101 (P/N 269205)

OPERATING SPECIFICATIONS

- Pressure regulation: 1.7 or 2.8 bar; 170 or 280 kPa
- Flow: 2 to 55 l/min
- Operating pressure: 1.4 to 8.0 bar; 140 to 800 kPa
- Operating temperature: up to 66°C
- 150 mesh (100 microns) stainless steel screen

SOLENOID OPERATING SPECIFICATIONS

- Heavy-duty solenoid 24 VAC
 - 350 mA inrush current, 190 mA holding current, 60 Hz
 - 370 mA inrush current, 210 mA holding current, 50 Hz
- Warranty period: 2 years



PCZ-101

Height: 18 cm
 Width: 7 cm
 Length: 26 cm
 1" (25 mm) BSP inlet x 3/4" outlet

PCZ-101 Installed



DRIP CONTROL ZONE KITS	
Model	Description
PCZ-101-25-B	1" (25 mm) flow control PGV Valve with HFR; 1.7 bar; 170 kPa regulator, 3/4" outlet
PCZ-101-40-B	1" (25 mm) flow control PGV Valve with HFR; 2.8 bar; 280 kPa regulator, 3/4" outlet

PCZ CONTROL ZONE KITS: PRESSURE REQUIREMENTS BASED ON FLOW					
System Flow		PCZ-101-25-B (1.7 bar/170 kPa outlet)		PCZ-101-40-B (2.8 bar/280 kPa outlet)	
l/min	m ³ /hr	Inlet pressure required to achieve desired outlet pressure			
		bar	kPa	bar	kPa
1.9	0.14	2.3	234	2.8	283
3.8	0.28	2.3	235	2.0	290
19.0	1.14	2.3	234	3.1	310
37.8	2.27	2.6	255	3.6	358
56.8	3.41	2.8	283	4.1	407

FILTERS & FILTER REGULATORS

Choose rugged filters and filter regulators for maximum performance.

KEY BENEFITS

- HFR-075 (Hunter Filter Regulator)
 - Compact, all-in-one filter and regulator minimise required valve box space
 - Senninger regulator provides precise regulation to protect system from high pressure
 - 150 mesh (100 microns) stainless steel screen for years of reliable filtration
 - Operating pressure: Up to 8 bar; 800 kPa
 - Wide flow range covers most drip applications
 - Warranty period: 2 years
- ¾" HY Filter
 - 150 mesh (100 microns) stainless steel screen for years of reliable filtration
 - Operating pressure: up to 8 bar; 800 kPa
 - Warranty period: 2 years
- 1", 1½", and 2" (25 mm, 40 mm, and 50 mm) HY Filter
 - Glass-filled polypropylene body for added strength and durability
 - Filter type: Disc filter, 120 mesh (125 microns)
 - Operating pressure: Up to 10 bar; 1,000 kPa
 - Large disc filtration provides longer life between cleanings
 - Warranty period: 2 years



HFR-075

Height: 18 cm
Width: 7 cm
Length: 16 cm
¾" inlet x ¾" outlet



HY-075

HY-100
Height: 15 cm
Width: 7 cm
Length: 13 cm



HY-151

Height: 23 cm
Width: 13 cm
Length: 23 cm



HY-201

Height: 31 cm
Width: 18 cm
Length: 30 cm

HUNTER FILTERS

Model	Description
HFR-075-25	Filter regulator, ¾" inlet/outlet, 1.7 bar; 170 kPa
HFR-075-40	Filter regulator, ¾" inlet/outlet, 2.8 bar; 280 kPa
HY-075	¾" screen filter with ¾" inlet/outlet
HY-100-D-BSP	1" (25 mm) BSP disc filter, 10 bar; 1,000 kPa
HY-151-D-BSP	1½" (40 mm) BSP disc filter, 10 bar; 1,000 kPa
HY-201-D-BSP	2" (50 mm) BSP disc filter, 10 bar; 1,000 kPa

SENNINGER™ PRESSURE REGULATORS

Choose the most consistent and reliable pressure regulators in the industry.

KEY BENEFITS

- Maintain consistent preset outlet pressure to prevent damage to system components
- 100% water-tested to ensure accuracy and dependable operation
- Install above or below ground for convenience of design
- Tamper-proof construction provides reliability and long life
- Very low hysteresis and friction loss help maintain accurate regulation
- No external metal parts for excellent corrosion resistance

OPERATING SPECIFICATIONS

- PRL (3/4"):
 - Flow range: 2 to 30 l/min
 - Maximum inlet pressure*: 6.9 to 8.3 bar; 690 to 830 kPa
- PRLG:
 - Flow range: 2 to 27 l/min
 - Maximum inlet pressure*: 8.3 bar; 830 kPa
- PMR-MF (3/4"):
 - Flow range: 7.5 to 75.7 l/min
 - Maximum inlet pressure*: 6.9 to 9.0 bar; 690 to 900 kPa
- Warranty period: 2 years

*Maximum recommended inlet pressure should not exceed 5.5 bar; 550 kPa above nominal model pressure

PRL (3/4") USE FOR STANDARD LOW-FLOW IRRIGATION APPLICATIONS

Model	Outlet Pressure	Inlet	Outlet
PRL203F3F	1.38 bar; 138 kPa	3/4" FNPT	3/4" FNPT
PRL253F3F	1.72 bar; 172 kPa	3/4" FNPT	3/4" FNPT
PRL303F3F	2.07 bar; 207 kPa	3/4" FNPT	3/4" FNPT
PRL353F3F	2.41 bar; 241 kPa	3/4" FNPT	3/4" FNPT

PRLG 3/4" HOSE THREAD

Model	Outlet Pressure	Inlet	Outlet
PRLG253FH3MH	1.72 bar; 172 kPa	3/4" FHT	3/4" MHT

PMR-MF (3/4")

Model	Pressure	Inlet	Outlet
PMR20MF3F3FV	1.38 bar; 138 kPa	3/4" NPT	3/4" NPT
PMR25MF3F3FV	1.72 bar; 172 kPa	3/4" NPT	3/4" NPT
PMR30MF3F3FV	2.07 bar; 207 kPa	3/4" NPT	3/4" NPT
PMR40MF3F3FV	2.76 bar; 276 kPa	3/4" NPT	3/4" NPT
PMR50MF3F3FV	3.45 bar; 345 kPa	3/4" NPT	3/4" NPT



**PRL Pressure Regulator
Low-Flow**

Width: 4.8 cm
Length: 11.4 cm
3/4" FNPT inlet x 3/4" FNPT outlet



**PRLG Pressure Regulator
Low-Flow 3/4" hose thread**

Width: 4.8 cm
Length: 11.4 cm
3/4" FNPT inlet x 3/4" FNPT outlet



**PMR-MF Pressure-Master Regulator
Medium-Flow**

Width: 6.4 cm
Length: 14.0 cm
3/4" female inlet x 3/4" female outlet

The pressure regulator will maintain the predetermined operating pressure, provided that the inlet pressure is at least 0.35 bar; 35 kPa above the expected outlet pressure, but not exceeding the maximum operating pressure.

CONTROL ZONE KITS

DRIPLINE SYSTEMS

Ultra-durable Hunter Dripline solutions are easy to install and provide maximum longevity in the field. HDL and PLD work efficiently and effectively to use as little water as possible and keep plants thriving.

1 The dripline grid is a common installation practice either at grade or subsurface. Establishing consistent laterals in dense plantings provides a quick and simple approach to irrigating a planted area.

2 Arranging the dripline through a series of plants is an accepted and reliable method of irrigation. Ensure the dripline has emission points near or around each plant.

3 Multi-Purpose Box:

- 25 cm x 18 cm opening
- Five colour options for lids

4 Control Zone Kit:

- Factory-assembled for quick and easy installation
- Low-, medium-, and high-flow kits

5 PLD/HDL:

- All versions are pressure-compensating
- Check valve options available

6 Fittings:

- Double-barb holds fittings tight
- LOC Fittings can be reused

7 Air/Vacuum Relief Valve:

- Helps prevent water hammer and tubing collapse
- Use at high point(s) in zone

8 Eco-Indicator:

- Pops up at 0.85 bar; 85 kPa and shows system is running
- Reveals when system pressure drops too low

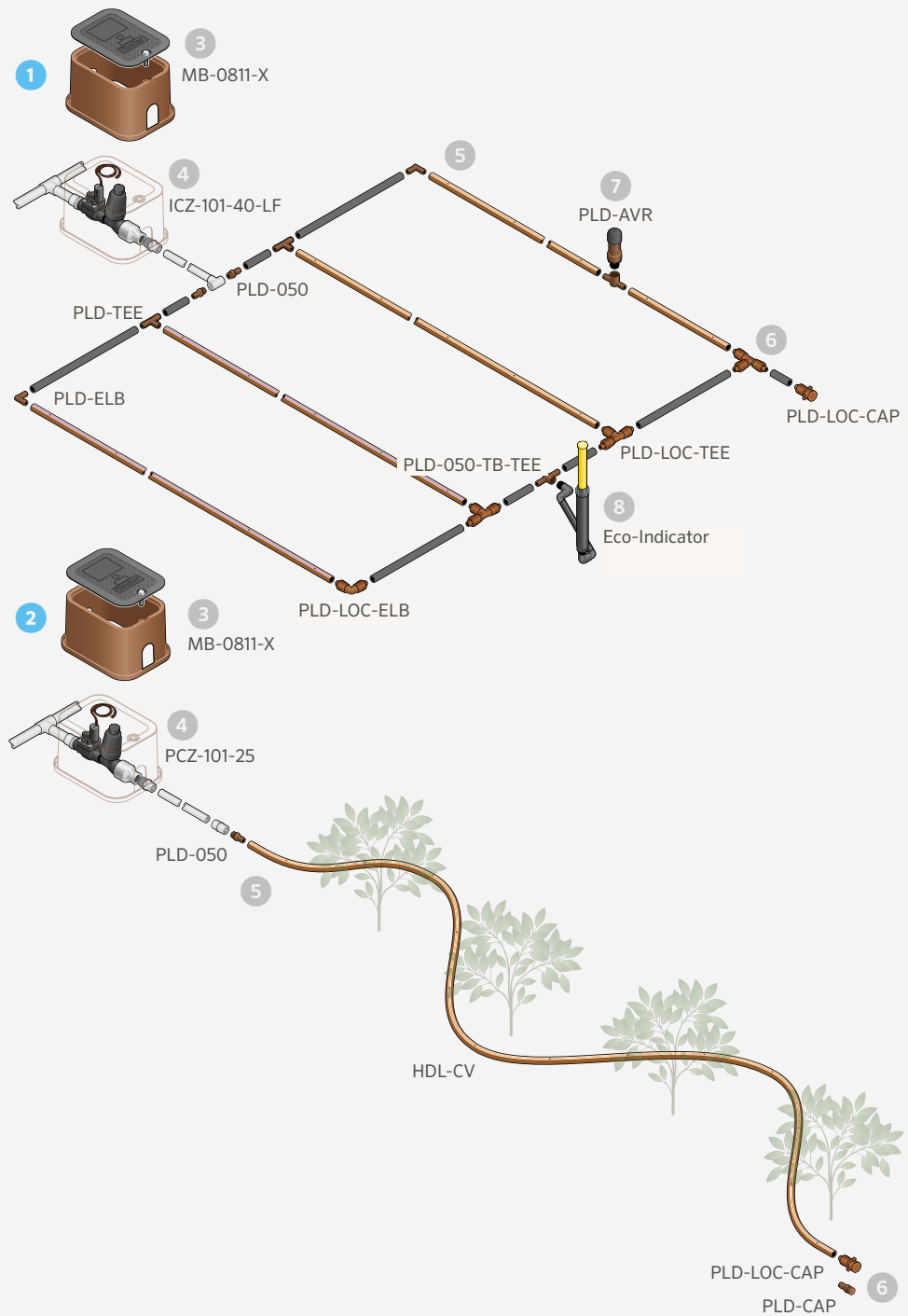

HDL-CV (17 MM)

Increase drip system efficiency with pressure compensation, flow indication stripes, and a 1.8 m check height.

KEY BENEFITS

- Pressure-compensating emitters for consistent flow and uniform coverage
- Non-draining check valve (CV-ND) prevents low-point pooling and allows all emitters to open/close at the same time for greater system efficiency
- Check height of 1.8 m minimises system drainage and runoff
- Anti-siphon feature prevents debris from entering emitter at system shutdown
- Colour-coded stripes provide easy identification of flow
- UV resistance facilitates product longevity
- Stretch-wrapped coils stay intact and make installation quick and easy
- Superior grit tolerance provided by proprietary emitter design with multiple inlet filters, a wide turbulent labyrinth, and a full-size outlet pool

PRODUCT SPECIFICATIONS

- Available flow rates: 1.5, 2.1, 3.4 l/hr
- Available emitter spacing: 30 cm, 45 cm, 60 cm
- Tubing dimensions: 16.76 mm x 14.22 mm (outside/inside diameter)
- Wall thickness: 1.2 mm

OPERATING SPECIFICATIONS

- Operating range: 1 to 4.2 bar; 100 to 420 kPa
- Minimum filtration: 120 mesh (125 microns)
- Warranty period: 5 years (plus 2 additional years for environmental stress cracking)



HDL-CV



Coil with Stretch Wrap

HDL-CV				
Model	Flow	Spacing	Length	
HDL-04-12-250-CV	1.5 l/hr	30 cm	75 m	
HDL-04-12-1K-CV			300 m	
HDL-04-18-250-CV		45 cm	75 m	
HDL-04-18-1K-CV			300 m	
HDL-06-12-100-CV	2.1 l/hr	30 cm	30 m	
HDL-06-12-250-CV			75 m	
HDL-06-12-500-CV			150 m	
HDL-06-12-1K-CV		300 m		
HDL-06-18-250-CV		45 cm	75 m	
HDL-06-18-1K-CV			300 m	
HDL-06-24-250-CV			75 m	
HDL-09-12-100-CV		3.4 l/hr	30 cm	30 m
HDL-09-12-250-CV				75 m
HDL-09-12-500-CV				150 m
HDL-09-12-1K-CV	300 m			
HDL-09-18-250-CV	45 cm		75 m	
HDL-09-18-1K-CV			300 m	
HDL-09-24-250-CV			75 m	



HUNTER DRIPLINE COLOUR CODE

STRIPE COLOUR

- 3.4 l/hr - Black
- 2.1 l/hr - Grey
- 1.5 l/hr - Tan

TUBING COLOUR

- HDL-CV - Dark brown tubing, pressure-compensating with check valve

Compatible with:

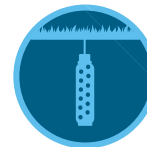

Soil-Clik™
Sensor
Page 157



Eco-Indicator
Page 181



PLD Fittings
Page 164

HDL-PC & HDL-R (17 MM)

Maximise drip system longevity with robust material construction and pressure compensation for standard and reclaimed applications.

KEY BENEFITS

- Pressure-compensating emitters for consistent flow and uniform coverage
- Colour-coded stripes provide easy identification of flow
- UV resistance facilitates product longevity
- Stretch-wrapped coils stay intact and make installation quick and easy
- Superior grit tolerance provided by proprietary emitter design with multiple inlet filters, a wide turbulent labyrinth, and a full-size outlet pool
- Reclaimed product (HDL-R) identified by purple stripes assists in visual identification when using non-potable water

PRODUCT SPECIFICATIONS

- Available flow rates: 2.1, 3.4 l/hr
- Available emitter spacing: 30 cm, 45 cm, 60 cm
- Tubing dimensions: 16.76 mm x 14.22 mm (outside/inside diameter)
- Wall thickness: 1.2 mm

OPERATING SPECIFICATIONS

- Operating range: 1 to 4.2 bar; 100 to 420 kPa
- Minimum filtration: 120 mesh (125 microns)
- Warranty period: 5 years (plus 2 additional years for environmental stress cracking)

HDL-PC			
Model	Flow	Spacing	Length
HDL-06-12-250-PC	2.1 l/hr	30 cm	75 m
HDL-06-12-500-PC			150 m
HDL-06-18-250-PC		45 cm	75 m
HDL-09-12-250-PC	3.4 l/hr	30 cm	75 m
HDL-09-12-500-PC			150 m
HDL-09-18-250-PC		45 cm	75 m

HDL-R			
Model	Flow	Spacing	Length
HDL-06-12-250-R	2.1 l/hr	30 cm	75 m
HDL-06-12-1K-R			300 m
HDL-06-18-250-R		45 cm	75 m
HDL-06-18-1K-R			300 m
HDL-09-12-250-R	3.4 l/hr	30 cm	75 m
HDL-09-12-1K-R			300 m
HDL-09-18-250-R		45 cm	75 m
HDL-09-18-1K-R			300 m



HDL-PC



HDL-R (Reclaimed)

Optional colour for reclaimed water sources, available for 17 mm only.

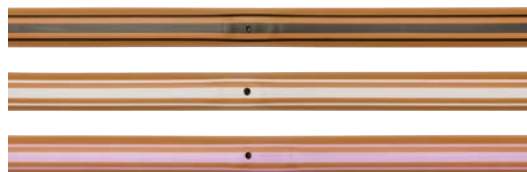

HUNTER DRIPLINE COLOUR CODE

STRIPE COLOUR

- 3.4 l/hr - Black
- 2.1 l/hr - Grey
- Reclaimed - Purple

TUBING COLOUR

- HDL-PC - Light brown tubing, pressure-compensating
- HDL-R - Light brown with purple stripe, pressure-compensating, reclaimed

See **page 209** for Maximum Run Length Chart.

Compatible with:

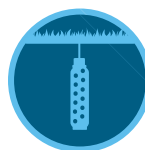

Soil-Clik
Page 157



Eco-Indicator
Page 181



PLD Fittings
Page 177

HDL-BLNK (17 MM)

UV-resistant HDL Blank Tubing is a useful addition to any drip system.

KEY BENEFITS

- UV resistance facilitates product longevity
- Stretch-wrapped coils stay intact and make installation quick and easy
- Accepts Hunter PLD-LOC and 17 mm barb fittings for ease of connection
- Earth-tone tubing prevents bright spots in the landscape
- Purple stripes for reclaimed applications

PRODUCT SPECIFICATIONS

- Tubing dimensions: 16.76 mm x 14.22 mm (outside/inside diameter)
- Wall thickness: 1.2 mm

OPERATING SPECIFICATIONS

- Operating range: Up to 4.2 bar; 420 kPa
- Warranty period: 5 years (plus 2 additional years for environmental stress cracking)



HDL-BLNK



HDL-BLNK-R

HDL-BLNK			
Model	Flow	Spacing	Length
HDL-BLNK-100	Blank tubing		30 m
HDL-BLNK-250			75 m
HDL-BLNK-500			150 m
HDL-BLNK-1K			300 m
HDL-BLNK-500-R	Blank tubing (reclaimed)		150 m

HDL-COP (16 MM)

Minimise the risk of root intrusion by adding copper to industry-leading Hunter Dripline.

KEY BENEFITS

- Emitters infused with copper oxide (Cu₂O) provide triple protection against root intrusion
- Long-term, safe, and non-leaching solution
- Slow-draining check valve (CV) emitters prevent low-point pooling and boost system efficiency
- Pressure-compensating emitters provide consistent flow over the entire lateral length
- Anti-siphon feature prevents debris from entering emitters
- Colour-coded stripes provide easy flow identification
- UV resistance facilitates product longevity
- Stretch-wrapped coils stay intact and make installation quick and easy
- Multiple inlet filters in the emitter and a wide turbulent labyrinth provide superior grit tolerance
- Full-sized emitter outlet pool and raised wall keep debris and roots from entering the emitter

PRODUCT SPECIFICATIONS

- Emitter spacing: 30 cm, 45 cm
- Tubing dimensions: 16.2 mm x 13.8 mm (outside/inside diameter)
- Wall thickness: 1.2 mm
- Diaphragm: Silicone

OPERATING SPECIFICATIONS

- Available flow rates: 2.1, 3.4 l/hr
- Operating range: 1.0 to 4.2 bar; 100 to 420 kPa
- Minimum filtration: 120 mesh (125 microns)
- Warranty period: 5 years (plus 2 additional years for environmental stress cracking)
- No warranty against root intrusion

HDL-COP			
Model	Flow	Spacing	Length
HDL-22-30-400-COP	2.1 l/hr	30 cm	400 m
HDL-22-45-400-COP		45 cm	400 m
HDL-34-30-400-COP	3.4 l/hr	30 cm	400 m
HDL-34-45-400-COP		45 cm	400 m

Note: While the use of copper does not completely remove the chance of root intrusion, it has been shown to assist in its prevention when coupled with proper irrigation scheduling.



HDL-COP



Coil with Stretch Wrap



HUNTER DRIPLINE COLOUR CODES

STRIPE COLOUR

- 2.1 l/h - Grey
- 3.4 l/hr - Black

TUBING COLOUR

- HDL-COP - Pressure-compensating, earth-tone copper tubing with slow-draining check valve

See **page 209** for Maximum Run Length Charts.

Compatible with:

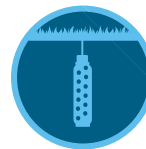

Soil-Clik™
Sensor
Page 157



Eco-Indicator
Page 181



PLD Fittings
Page 164

PLD (16 MM)

High-quality, pressure-compensating emitters make PLD a great choice for most landscapes.

KEY BENEFITS

- Pressure-compensating emitters
- Flow rates of 2.2, 3.8 l/hr
- Emitter spacing at 30 cm and 50 cm
- Use with PLD-LOC or barbed PLD Fittings
- Strong UV resistance
- Check valves keep the line charged up to 1.5 m and prevent low-point drainage
- Anti-siphon prevents debris from entering emitters when used subsurface

OPERATING SPECIFICATIONS

- Pressure-compensating, non-draining emitters
- Operating pressure range: 1.0 to 3.5 bar; 100 to 350 kPa
- Minimum filtration: 120 mesh (125 microns)
- Warranty period: 5 years



PLD-CV

PLD Installed



DRIPLINE SYSTEMS

16 MM EMITTER FLOW RATE 2.2 l/hr		
Row Spacing (m)	Emitter Spacing (m)	
		0.30
0.30	24	15
0.35	21	13
0.40	18	11
0.45	16	10
0.50	15	9
0.55	13	8
0.60	12	7

16 MM EMITTER FLOW RATE 3.8 l/hr		
Row Spacing (m)	Emitter Spacing (m)	
		0.30
0.30	42	25
0.35	36	22
0.40	32	19
0.45	28	17
0.50	25	15
0.55	23	14
0.60	21	13

16 MM DRIPLINE MAX LENGTH 2.2 l/hr		
Pressure (bar; kPa)	Emitter Spacing (m)	
		0.30
1.0; 100	47	73
2.0; 200	84	131
3.0; 300	104	162

16 MM DRIPLINE MAX LENGTH 3.8 l/hr		
Pressure (bar; kPa)	Emitter Spacing (m)	
		0.30
1.0; 100	35	54
2.0; 200	59	91
3.0; 300	72	112

16 MM QUICK REFERENCE CHART l/min PER 100 M		
Emitter (l/hr)	Emitter Spacing (m)	
		0.30
1.5	12.2	7.3
3.8	21.1	12.7

Notes:
PLD is subject to order minimums. Please contact your distributor for more information.

PLD 16 MM - SPECIFICATION BUILDER: ORDER 1 + 2 + 3						
1	Model	2	Spacing	3	Length	
	PLD-22 = 2.2 l/hr flow	30 cm	100 = 100 m			CV = Pressure-compensating, check valve
	PLD-38 = 3.8 l/hr flow	50 cm	200 = 200 m			
			400 = 400 m			

Examples:

- PLD-22-30-100-CV = 2.2 l/hr dripline with 30 cm spacing in a 100 m roll
- PLD-22-50-200-CV = 2.2 l/hr dripline with 50 cm spacing in a 200 m roll
- PLD-38-50-400-CV = 3.8 l/hr dripline with 50 cm spacing in a 400 m roll

PLD BARB FITTINGS (16 MM)

Ensure a superior hold with robust acetal construction.

KEY BENEFITS

- Acetal material provides a secure connection
- Dual barb removes the need for clamps

PRODUCT SPECIFICATIONS

- Use with PLD or other 16 mm dripline

OPERATING SPECIFICATIONS

- Pressure range: up to 7 bar; 700 kPa
- Warranty period: 1 year



PLD-CPL-16
16 mm barb x barb



PLD-050-16
1/2" (12 mm) MPT x 16 mm barb



PLD-ELB-16
16 mm barb x barb elbow



PLD-TEE-16
16 mm barb x barb tee



PLD-BV-16
16 mm barb x barb ball valve

PLD INSERT BARBS- 16 MM

Model	Description
PLD-CPL-16	16 mm barb x barb
PLD-050-16	1/2" MPT x 16 mm barb
PLD-ELB-16	16 mm barb x barb elbow
PLD-TEE-16	16 mm barb x barb tee
PLD-BV-16	16 mm barb x barb ball valve
PLD-075-16	3/4" MPT x 16 mm barb

PLD LOC FITTINGS (16-18 MM)

LOC Fittings are compatible with any nominal 1/2" tubing and dripline for quicker installs and easier repairs.

KEY BENEFITS

- Glass-filled polypropylene for added durability
- Thread lock connection method provides a secure connection while still allowing flexibility for service and system changes

PRODUCT SPECIFICATIONS

- Use with 16 to 18 mm dripline or tubing
- Install with PLD-IAC/PLD-IAE grommet and a 17.5 mm spade drill bit

OPERATING SPECIFICATIONS

- Operating pressure range: Up to 10 bar; 1,000 kPa
- Warranty period: 2 years



PLD-LOC 075
3/4" male pipe thread x LOC



PLD-LOC 050
1/2" male pipe thread x LOC



PLD-LOC CAP
End cap x LOC



PLD-LOC ELB
Locking elbow



PLD-LOC CPL
Locking coupler



PLD-LOC FHS
3/4" female hose swivel x LOC



PLD-LOC TEE
Locking tee

PLD BARB FITTINGS (17 MM)

Acetal construction holds vinyl and PE tubing for an ideal low-cost choice when installing dripline.

KEY BENEFITS

- Acetal material provides a secure connection
- Dual barb removes the need for clamps

PRODUCT SPECIFICATIONS

- Use with HDL or other 17 mm dripline
- Install with PLD-IAC/PLD-IAE grommet and a 17.5 mm spade drill bit

OPERATING SPECIFICATIONS

- Operating pressure range: up to 7 bar; 700 kPa
- Warranty period: 1 year



PLD-050
1/2" MPT x 17 mm barb



PLD-ELB
17 mm barb elbow



PLD-075
3/4" MPT x 17 mm barb



PLD-CPL
17 mm barb coupling



PLD-CAP
17 mm barb x 1/2" MPT with cap



PLD-075-TB-TEE
17 mm barb tee x 3/4" thread



PLD-BV
17 mm barb shut-off valve



PLD-TEE
17 mm barb tee



PLD-075-TB-ELB
3/4" FPT x 17 mm barb elbow



PLD-050-TB-TEE
1/2" FPT x 17 mm barb tee



PLD-IAC
(with grommet)
Insert adapter x 17 mm coupling



PLD-IAE
(with grommet)
Insert adapter x 17 mm elbow



PLD-CRS
17mm barb cross

SUBSURFACE SYSTEMS

Subsurface drip irrigation systems can be extremely effective at saving water and encouraging root growth. Hunter is the only manufacturer to offer three tiers of top-quality subsurface irrigation solutions: HDL-COP Dripline, the Eco-Wrap™ System, and the Eco-Mat™ System.

1 Eco-Mat offers 30% greater efficiency than any other bare subsurface dripline product. It installs under the soil like a blanket of water, ready for the roots to absorb what they need.

2 Eco-Wrap provides resistance to root intrusion while enhancing the capillary action and efficiency of the system. Eco-Wrap combines the quality of HDL with the wicking properties of polyethylene fleece.

3 Entry Manifold:

- PVC (for stability) or polyethylene
- Assemble with either 17 mm or LOC Fittings

4 Multi-Purpose Box:

- 25 cm x 18 cm opening
- Five colour options for lids

5 Control Zone Kit:

- Factory-assembled for quick and easy installation
- Low-, medium-, and high-flow kits

6 Air/Vacuum Relief Valve:

- Helps prevent water hammer and tubing collapse
- Use at high point(s) in zone

7 Eco-Indicator:

- Pops up at 0.85 bar; 85 kPa and shows system is running
- Reveals when system pressure drops too low

8 Fittings:

- Double-barb holds fittings tight
- LOC Fittings can be reused

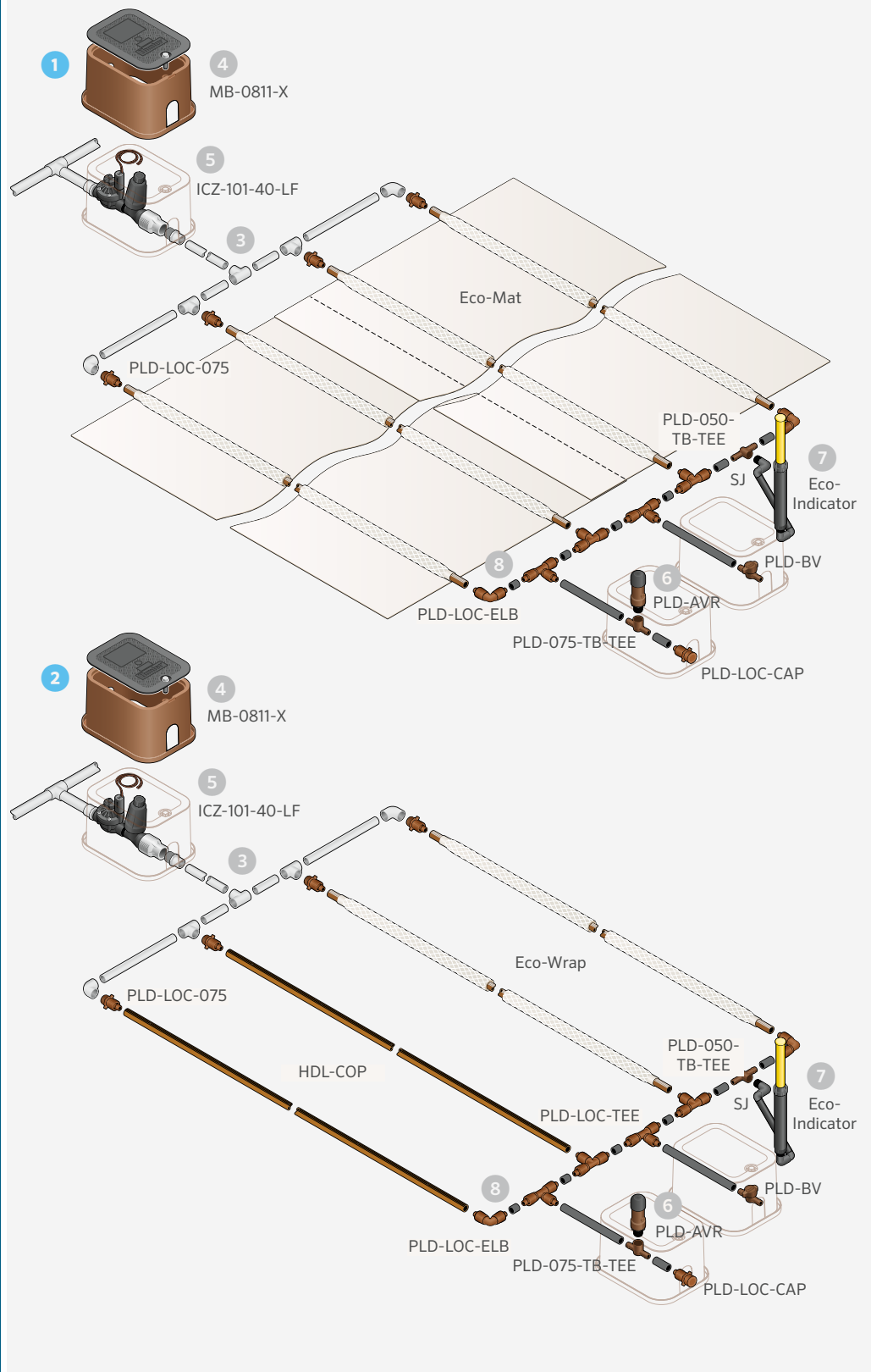

ECO-MAT™

Irrigate plants below the root zone for maximum efficiency with a combination of fleece-wrapped dripline and fleece blanket.

KEY BENEFITS

- Anti-siphon feature and fleece wrap protect against debris and root intrusion
- Saves 20 to 40% more water than standard products due to superior capillary movement of water to the entire root zone, promoting healthier root growth
- Non-draining, pressure-compensating emitters open/close simultaneously, maximising efficiency
- Check height of 1.5 m minimises system drainage and runoff

PRODUCT SPECIFICATIONS

- Flow rate: 2.2 l/hr; 0.13 m³/hr
- Emitter spacing: 30 cm
- Lateral row spacing: 35 cm
- Product width: 0.80 m
- Roll length: 16 mm = 100 m; 17 mm = 90 m
- Tubing dimensions: 0.660" x 0.560" (outside/inside diameter)
- Accepts 16/17 mm barb (depending on Eco-Mat selection) or LOC Fittings
- Water-holding capacity: 1.89 l/m³
- Approximate coverage per roll: 100 m roll = 75 m²; 90 m roll = 67 m²
- Example calculation based on area 12 m x 24 m:

$$\text{Roll Qty.} = \frac{\text{Irrigated landscape area}}{\text{Area of roll coverage}} = \frac{288 \text{ m}^2}{67 \text{ m}^2} = 4.3 \text{ (round up to 5 rolls)}$$

OPERATING SPECIFICATIONS

- Operating range: 1.0 to 3.5 bar; 100 to 350 kPa
- Minimum filtration: 120 mesh (125 microns)
- Air relief recommended for sloping conditions greater than 1.5 m
- Recommended installation depth: turf (10 to 15 cm); other (10 to 30 cm)
- May use in conjunction with the Eco-Wrap™ System
- Warranty period: 5 years

Eco-Mat Installed



ECO-MAT

Model	Description
ECO-MAT-16	PLD (16 mm) fleece drip mat, 100 m roll
ECO-MAT-17	HDL (17 mm) fleece drip mat, 90 m roll

Compatible with:

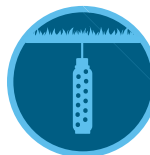

Soil-Clik
Page 157



Eco-Indicator
Page 181

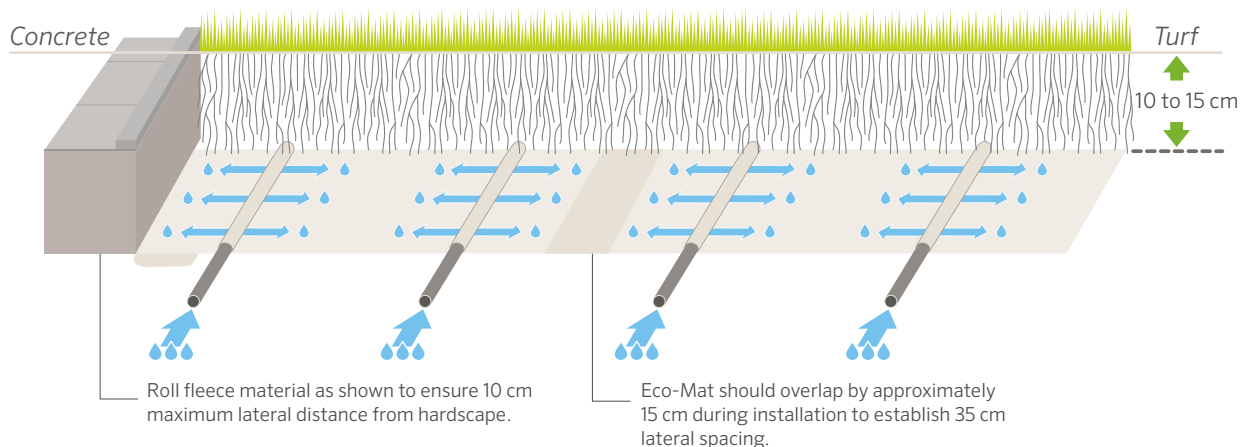

ECO-WRAP™

Irrigate more efficiently than blank dripline with fleece-wrapped dripline.

KEY BENEFITS

- Perfect for narrow areas that are difficult to irrigate with standard methods
- Anti-siphon feature and fleece wrap protect against debris and root intrusion
- Saves 20 to 40% more water than standard products due to superior capillary movement of water to the entire root zone, promoting healthier root growth
- Non-draining, pressure-compensating emitters open/close simultaneously, maximising efficiency
- Check height of 1.5 m minimises system drainage and runoff

PRODUCT SPECIFICATIONS

- Flow rate: 2.1 l/hr
- Emitter spacing: 30 cm
- Tubing dimensions: 0.660" x 0.560" (outside/inside diameter)
- Roll length: 16 mm = 100 m; 17 mm = 90 m
- Accepts 16 mm barb or LOC Fittings

OPERATING SPECIFICATIONS

- Operating range: 1.0 to 3.5 bar; 100 to 350 kPa
- Minimum filtration: 120 mesh (125 microns)
- Air relief recommended for sloping conditions greater than 1.5 m
- Recommended installation depth: turf (10 to 16 cm); other (10 to 30 cm)
- Compatible with the Eco-Mat™ System
- Warranty period: 5 years

MAXIMUM RUN LENGTH FOR ECO-MAT AND ECO-WRAP

Pressure (bar; kPa)	Length (m)
1.0; 100	52
1.5; 150	75
2.0; 200	95
2.5; 250	106
3.5; 350	126
4.0; 400	130



Eco-Wrap

ECO-WRAP

Model	Description
ECO-WRAP-16	PLD (16 mm) fleece drip wrap, 100 m roll
ECO-WRAP-17	HDL (17 mm) fleece drip wrap, 75 m roll

Eco-Wrap Installed



Compatible with:

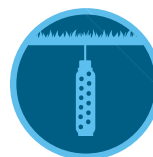

Soil-Clik
Page 157



Eco-Indicator
Page 181

ECO-INDICATOR

Confirm system operation and adequate pressure with this handy visual device.

KEY BENEFITS

- Visible bright yellow or reclaimed purple riser stem and cap indicate when system is in operation
- Stem pops up when pressure exceeds the threshold and assists in confirming low pressures if not raised
- Connects via bottom or side inlet ports for easy installation; side inlet port is available on 30 cm version

OPERATING SPECIFICATIONS

- ECO-ID:
 - Operating pressure: up to 5 bar; 500 kPa
 - Indication of system operation: above 0.8 bar; 80 kPa
 - Warranty period: 2 years
- ECO-ID-12/ECO-ID-12-R:
 - Operating pressure: up to 7 bar; 700 kPa
 - Indication of system operation: above 1 bar; 100 kPa
 - Warranty period: 5 years

USER-INSTALLED OPTIONS (FOR 30 CM ECO-INDICATOR)

- Drain check valve (up to 3 m of elevation: P/N 437400SP)
- SJ Swing Joint: SJ-512 (½" threaded x 30 cm length)

ECO-INDICATOR	
Model	Description
ECO-ID	15 cm Eco-Indicator
ECO-ID-12	30 cm Eco-Indicator
ECO-ID-12-R	30 cm Eco-Indicator, Reclaimed

Eco-Indicator Installed



ECO-ID

Retracted height: 24 cm
 Pop-up height: 15 cm
 Exposed diameter: 3 cm
 Inlet size: ½"



[A] ECO-ID-12

[B] ECO-ID-12-R

Retracted height: 41 cm
 Pop-up height: 30 cm
 Exposed diameter: 5.7 cm
 Inlet size: ½"

Compatible with:

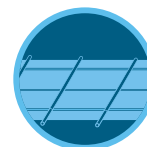

**Eco-Mat™
 System**
 Page 179

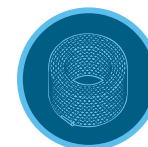

**Eco-Wrap™
 System**
 Page 180



**HDL and PLD
 Dripline**
 Page 171
 to 175

SUPPLY TUBING

UV-resistant polyethylene makes this 17.8 mm X 15.2 mm solution a useful addition to drip systems.

KEY BENEFITS

- Thick wall and UV resistance provide durability and longevity
- Kink resistance for added flexibility and quicker installation

PRODUCT SPECIFICATIONS

- 17.8 mm x 15.2 mm (outside x inside diameter)

OPERATING SPECIFICATIONS

- 0 to 4.1 bar; 0 to 410 kPa
- Warranty period: 2 years

SUPPLY TUBING (THICK-WALLED POLYETHYLENE)	
Model	Description
TWPE-700-100	½" PE tubing - 30 m
TWPE-700-250	½" PE tubing - 75 m
TWPE-700-500	½" PE tubing - 150 m

Example:

TWPE-700-250 = 17 mm polyethylene tubing in a 76 m roll



17 mm PE Tubing

MLD

Use this 6 mm dripline solution for tight spaces and raised planters.

KEY BENEFITS

- Superior flexibility makes MLD an excellent choice for small spaces and raised containers
- Properly irrigates without being intrusive to the landscape

PRODUCT SPECIFICATIONS

- Colours: brown or black polyethylene
- Emitter spacing: 15 cm or 30 cm
- Coil size: 30 m
- 6.4 mm x 4.5 mm (outside/inside diameter)
- Use with 6 mm barb fittings

OPERATING SPECIFICATIONS

- Pressure range: 0.7 to 2.8 bar; 70 to 280 kPa
- Minimum filtration: 150 mesh (120 microns)
- Maximum run lengths: 15 cm = 4.6 m; 30 cm = 9.2 m
- MLD flow chart; [see page 209](#)
- Warranty period: 2 years

MLD - SPECIFICATION BUILDER: ORDER 1 + 2 + 3 + 4							
1	Model	2	Spacing	3	Length	4	Options
	MLD-05	06	= 15 cm	100	= 30 m	BL	= Black
		12	= 30 cm			(blank)	= Brown

Example:

MLD-05 -12-100 = 1.9 l/hr mini dripline with 30 cm spacing in a 30 m roll, brown



MLD

MLD Installed

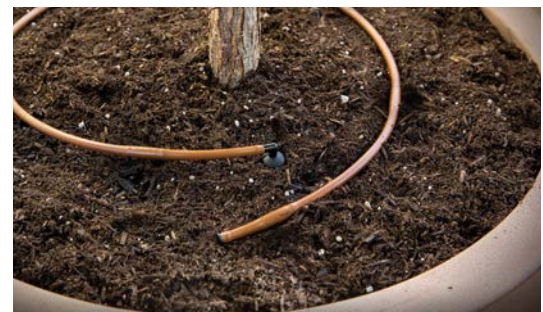

DISTRIBUTION TUBING

Add stability and flexibility to any system when using Point-Source Emitters or Micro Sprays.

KEY BENEFITS

- High-quality vinyl or polyethylene securely connects to acetal (6 mm) fittings
- Vinyl is more flexible, but it softens in high heat and should be used in cooler climates
- Polyethylene performs well in warmer climates

PRODUCT SPECIFICATIONS

- Material: Polyethylene or vinyl
- Coil sizes: 30 m, 75 m, and 300 m

OPERATING SPECIFICATIONS

- Operating pressure range: Up to 4.1 bar; 410 kPa
- Warranty period: 2 years



6 mm Tubing

6 MM TUBING – SPECIFICATION BUILDER: ORDER 1 + 2 + 3

1 Model	2 Tubing Diameter	3 Length
HQPE = Polyethylene tubing	250 = 6 mm barb	100 = 30 m
HQV = Vinyl tubing		250 = 75 m
		1K = 300 m

Example:

HQPE-250-1K = 6 mm polyethylene tubing in a 300 m roll

6 MM FITTINGS

Ensure a superior hold with robust acetal construction.

KEY BENEFITS

- Acetal material provides a secure connection
- Goof plug lays flat to help prevent leaking

PRODUCT SPECIFICATIONS

- Fits Hunter MLD and Distribution Tubing

OPERATING SPECIFICATIONS

- Pressure range: Up to 4 bar; 400 kPa
- Warranty period: 2 years



QB-TEE
6 mm barb tee



QB-ELB
6 mm barb elbow



QB-CPL
6 mm barb coupling



QB-CRS
6 mm barb cross



GP-025
Goof plug

6 mm Barb Fittings

Use with MLD or any vinyl or polyethylene 6 mm tubing, UV-stabilised materials, and durable single-barb connection.

RZWS

Deliver water across all levels of the root zone for high-efficiency subsurface irrigation of trees and shrubs.

KEY BENEFITS

- Patented StrataRoot™ Baffles divert water to all levels of the root zone while adding strength to the unit
- Durable locking cap for vandal resistance
- Pressure-compensating bubbler for accurate water flow
- Built-in Hunter Swing Joint for direct installation to ½" PVC fitting
- Preassembled for fast installation

OPERATING SPECIFICATIONS

- Bubbler flow rates: 0.9 l/min or 1.9 l/min
- Recommended pressure range: 1.0 to 4.8 bar; 100 to 480 kPa
- Warranty period: 2 years

FACTORY-INSTALLED OPTIONS

- Hunter check valve (HCV)
- Locking reclaimed water purple cap

USER-INSTALLED OPTIONS

- Fabric sleeve to prevent soil intrusion in sandy areas for 45 cm and 90 cm models (P/N RZWS-SLEEVE)
- Replacement cap for 45 and 90 cm models (P/N 913300SP)
- Locking reclaimed purple cap for 45 and 90 cm models (P/N 913301SP)
- Reclaimed water purple cap for 25 cm model (P/N RZWS10-RCC)



RZWS-10

Diameter: 5.1 cm
Length: 25 cm

RZWS-18

Tube diameter: 7.6 cm
Cap diameter: 12 cm
Length: 45 cm

RZWS-36

Tube diameter: 7.6 cm
Cap diameter: 12 cm
Length: 90 cm

RZWS Patented StrataRoot Baffles



Reclaimed models available
(Add **-R** to model number)

RZWS - SPECIFICATION BUILDER: Order 1 + 2 + 3

1 Model	2 Bubbler Flow Rate	3 Options
RZWS-10 = 25 cm Root Zone Watering System	25 = 0.9 l/min	(blank) = No option
RZWS-18 = 45 cm Root Zone Watering System	50 = 1.9 l/min	CV = Check valve
RZWS-36 = 90 cm Root Zone Watering System	(blank) = No bubbler or swing joint	R = Reclaimed cap
		CV-R = Check valve with reclaimed cap

Examples:

RZWS-18-25-CV = 45 cm Root Zone Watering System at 0.9 l/min, with check valve

RZWS-10-50-R = 25 cm Root Zone Watering System at 1.9 l/min, with reclaimed cap

RZWS-36-25-CV-R = 90 cm Root Zone Watering System at 0.9 l/min, with check valve and reclaimed cap

ADDITIONAL OPTION (SPECIFY SEPARATELY)

RZWS-SLEEVE = Field-installed sleeve made from filter fabric

RZWS-E

Cultivate stronger, deeper roots by delivering water and oxygen directly to the root zone of trees and shrubs.

KEY BENEFITS

- Top serviceable cap design
- Pressure-compensating bubbler for accurate water flow
- Built-in Hunter Swing Joint for direct installation to ½" PVC fitting
- Preassembled for fast installation

OPERATING SPECIFICATIONS

- Bubbler flow rates: 0.9 l/min or 1.9 l/min
- Recommended pressure range: 1.0 to 4.8 bar; 100 to 480 kPa
- Warranty period: 2 years

RZWS-E - SPECIFICATION BUILDER: Order 1 + 2

1 Model	2 Bubbler Flow Rate
RZWS-E-18 = 45 cm Root Zone Watering System	25 = 0.9 l/min
RZWS-E-36 = 90 cm Root Zone Watering System	50 = 1.9 l/min

Examples:

- RZWS-E-18-50 = 45 cm Root Zone Watering System, 1.9 l/min bubbler
 RZWS-E-36-25 = 90 cm Root Zone Watering System, 0.9 l/min bubbler



RZWS-E-18
 Diameter: 7.6 cm
 Length: 45 cm

RZWS-E-36
 Diameter: 7.6 cm
 Length: 90 cm

SOFT PIPE SYSTEMS

Using soft pipe to distribute irrigation water is acceptable in both commercial and residential applications. Polyethylene tubing is used in place of PVC and may be 1", ¾", or ½". Hunter offers a full suite of products that are compatible with soft pipe systems.

1 Tree and Shrub Rings:

- Convenient and efficient way to irrigate sparse plantings
- Use HDL or MLD to form the irrigation ring
- Connect with LOC Fittings for faster installation

2 6 mm PE Tubing:

- Use HDL-BLNK to distribute water
- Use 6 mm PE polyethylene (HQPE) or vinyl (HQV) to connect to emitters and micro sprays

3 Point-Source Emitters:

- Barbed emitters insert directly into PE tubing at the end of 6 mm vinyl/PE
- Colour-coded flows (2, 4, 8, 15, 23 l/hr)

4 Micro Spray Stakes:

- Use when higher flows are needed (0 to 114 l/hr)
- Throw water from 0 m to 3.6 m

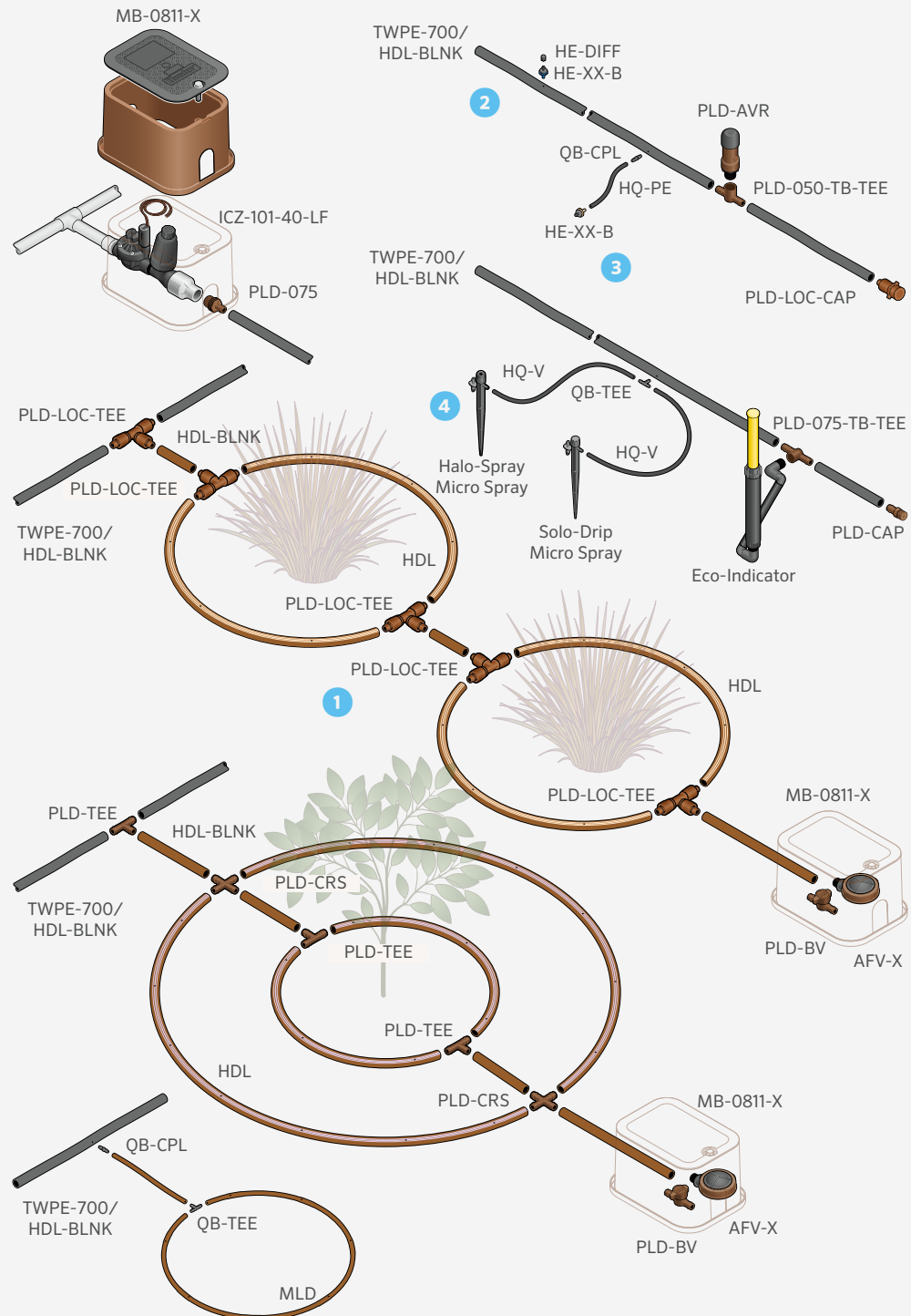

HARD PIPE SYSTEMS

From multi-port emitters to micro sprays, Hunter offers a wide variety of products and accessories that are designed to complement hard pipe systems.

1 IH Risers:

- Ultra-durable point-to-point emitters
- Built-in check valve screen makes them great for slopes
- Wide variety of flows

2 Point-Source Emitters:

- Colour-coded flows (2, 4, 8, 23 l/hr)
- HEB (1/2" threaded emitter bubblers install directly onto 1/2" risers)
- HE-T (10-32 threaded emitters install onto rigid risers)

3 Multi-Port Emitters:

- Colour-coded flows (0-119 l/hr)
- Swivel barbs for directional flow
- Install directly onto 1/2" risers

4 Micro Sprays:

- Ideal for higher flows (0-114 l/hr)
- Diameter of throw (0-3.4 m)
- Install directly onto rigid risers or on 1/4" tubing

5 Root Zone Watering System:

- For deep root irrigating
- Allows oxygen to penetrate the soil
- Encourages healthier root growth

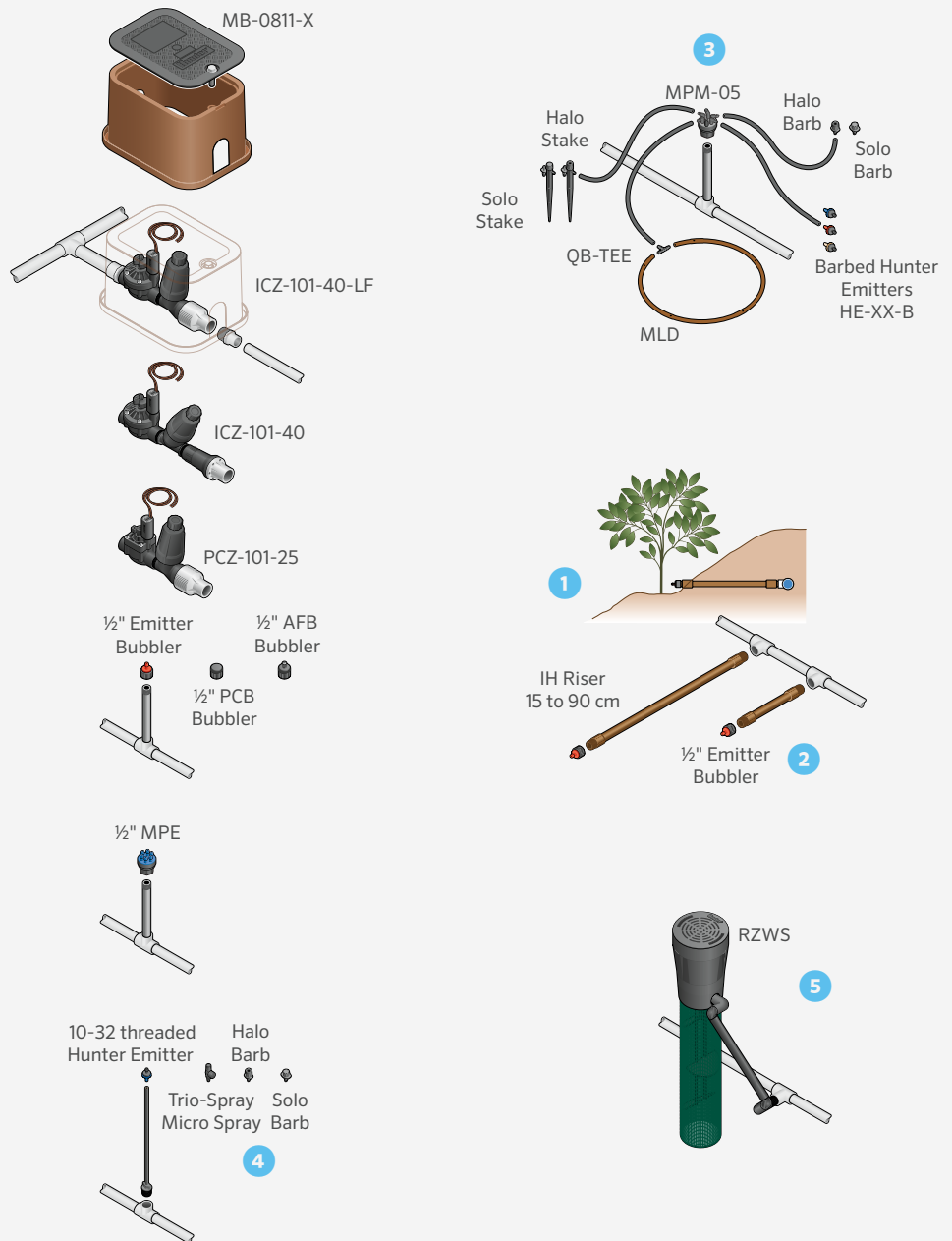

POINT-SOURCE EMITTERS

Ensure accurate irrigation for mixed and sparse plantings with a wide range of flow rates.

KEY BENEFITS

- Pressure-compensating for consistent and reliable flow
- Colour-coded by flow for easy identification in the field
- Self-flushing diaphragm
- Earth-tone colours blend in well with the surrounding environment
- Three inlet variations: 6 mm barb, 10-32 thread, ½" FPT
- Coined edges for easy grip
- Self-piercing barb for simple, no-tool installation
- Optional diffuser cap to gently distribute water at high flow

OPERATING SPECIFICATIONS

- Recommended pressure range: 1.4 to 3.5 bar; 140 to 350 kPa
- Minimum filtration: 150 mesh (100 microns)
- Warranty period: 2 years

½" FEMALE THREAD (BROWN BASE) WITH CHECK VALVE SCREEN

	Model	Inlet Type	Flow (l/hr)
● Blue	HEB-05-CV	½" female thread	2.0
● Black	HEB-10-CV	½" female thread	4.0
● Red	HEB-20-CV	½" female thread	8.0
● Tan	HEB-40-CV	½" female thread	15.0
● Orange	HEB-60-CV	½" female thread	23.0

EMITTER MODEL CHART

	Model	Inlet Type	Flow (l/hr)																			
● Blue	HE-050-B	Self-piercing barb	2.0																			
● Black	HE-10-B	Self-piercing barb	4.0																			
● Red	HE-20-B	Self-piercing barb	8.0																			
● Tan	HE-40-B	Self-piercing barb	15.0																			
● Orange	HE-60-B	Self-piercing barb	23.0																			
● Blue	HE-050-T	10-32 thread	2.0																			
● Black	HE-10-T	10-32 thread	4.0																			
● Red	HE-20-T	10-32 thread	8.0																			
● Tan	HE-40-T	10-32 thread	15.0																			
● Orange	HE-60-T	10-32 thread </tr <tr> <td>● Blue</td> <td>HEB-05</td> <td>½" female thread</td> <td>2.0</td> </tr> <tr> <td>● Black</td> <td>HEB-10</td> <td>½" female thread</td> <td>4.0</td> </tr> <tr> <td>● Red</td> <td>HEB-20</td> <td>½" female thread</td> <td>8.0</td> </tr> <tr> <td>● Tan</td> <td>HEB-40</td> <td>½" female thread</td> <td>15.0</td> </tr> <tr> <td>● Orange</td> <td>HEB-60</td> <td>½" female thread</td> <td>23.0</td> </tr>	● Blue	HEB-05	½" female thread	2.0	● Black	HEB-10	½" female thread	4.0	● Red	HEB-20	½" female thread	8.0	● Tan	HEB-40	½" female thread	15.0	● Orange	HEB-60	½" female thread	23.0
● Blue	HEB-05	½" female thread	2.0																			
● Black	HEB-10	½" female thread	4.0																			
● Red	HEB-20	½" female thread	8.0																			
● Tan	HEB-40	½" female thread	15.0																			
● Orange	HEB-60	½" female thread	23.0																			



DIFFUSER CAP

(HE-DIFF)

Use for flows higher than 8.0 l/hr to diffuse the water and prevent erosion



½" FEMALE THREAD

Brown base matches IH Risers and blends into the landscape



SCREEN-CV

Filter screen with 3.6 m check valve

Inlet Options

① Self-piercing barb



② 10-32 thread



③ ½" female thread



IH RISERS

Simplify point-to-point irrigation with vandal-resistant, heavy-duty IH Risers.

KEY BENEFITS

- Heavy-duty, military-grade, vandal-resistant design
- Made of flexible PVC for durability
- Brown components blend in with the landscape
- Purple fittings available for reclaimed water applications
- Accepts any ½" FPT emitter
- Ideal for slope applications
- At-grade or below-grade installation
- Available in multiple lengths for easy assembly
- Available as components for custom lengths

OPERATING SPECIFICATIONS

- Maximum flow: 26.5 l/min
- Maximum pressure: 4.1 bar; 410 kPa
- Warranty period: 2 years

IH Risers – SPECIFICATION BUILDER: ORDER 1 + 2 + 3

1 Model	2 Riser Length	3 Fitting Options
IH-RISER	06 = 15 cm riser 12 = 30 cm riser 18 = 45 cm riser 24 = 60 cm riser 36 = 90 cm riser	(blank) = Brown R = Reclaimed (purple fitting)

Example:
IH-RISER-12 = 30 cm flexible PVC riser with preglued ½" fittings

IH RISER COMPONENTS (SOLD SEPARATELY)

Model	Description
SCREEN-CV	Filter screen with 3.6 m check valve
IH-FIT-3850	¾" x ½" MPT IH fitting
IH-FIT-3850-R	¾" x ½" MPT IH fitting (reclaimed)
IH-250	75 m length of flexible PVC irrigation hose

RECOMMENDED GLUES FOR FLEXIBLE PVC

- IPS® Weld-On®:
 - P-68™ primer (recommended for PVC fittings only)
 - P-70™ primer (may be used, but P-68 is suggested)
 - 795™ Flex PVC cement
- Christy's®:
 - Purple Primer® or Red Hot Clear Primer® (fittings only)
 - Flex Pro PVC pipe cement
 - Red Hot Blue Glue® (not specialised for flexible PVC)

IPS, Weld-On, P-68, P-70, and 795 are trademarks of IPS Corporation. Christy's, Purple Primer, Red Hot Clear Primer, and Red Hot Blue Glue are trademarks of T. Christy Enterprises.



IH RISERS



SCREEN-CV
Filter screen with 3.6 m check valve



IH-FIT-3850, IH-FIT-3850-R
¾" x ½" MPT IH fitting



IH-250
Flexible PVC for creating headers or custom risers

Compatible with:



Point-Source Emitters
Page 188



Bubblers
Page 88



Multi-Port Emitters
Page 190

MULTI-PORT EMITTERS

Use these emitters to irrigate groups of plants effectively from one source.

KEY BENEFITS

- Six pressure-compensating emitter ports provide consistent and reliable flow
- Colour-coded by flow for easy identification
- Earth-tone colours blend in with surrounding landscape
- Swivel elbows assist in placing water directly to plant
- MPM (Multi-Port Manifold) provides unrestricted flow for each outlet

PRODUCT SPECIFICATIONS

- Available in ½" FNPT
- Available flows: 2, 4, 8 l/hr
- PVC cap plugs port when not being used

OPERATING SPECIFICATIONS

- Pressure range: 1.4 to 3.5 bar; 140 to 350 kPa
- Minimum filtration: 150 mesh (100 microns)
- Warranty period: 2 years

MULTI-PORT EMITTER MODEL CHART

	Model	Flow (l/hr)
● Blue	MPE-05	2.0
● Black	MPE-10	4.0
● Red	MPE-20	8.0
● Grey	MPM-050	N/A



Multi-Port Emitter



Multi-Port Manifold (MPM-050)

Unrestricted flow through outlets as indicated by grey colour. Use with 6 mm distribution tubing and a barbed emitter at the end (available in ½" FPT). Allows water to be directed to as many as six different locations.

Emitter Caps (MPE-CAPS)

Plug unused 6 mm barbed emitter outlets. Use with Hunter Multi-Port Emitters.



RIGID RISERS

These risers maintain their stiffness even when used with micro sprays, making them a perfect choice for high-throw applications.

KEY BENEFITS

- Provide a rigid connection for emitters and micro sprays
- Increase the height of sprays for flower beds

PRODUCT SPECIFICATIONS

- Inlet configurations: blank, 6 mm barb, ½" FNPT

OPERATING SPECIFICATIONS

- Pressure range: 1.4 to 4.1 bar; 140 to 410 kPa
- Warranty period: 1 year



30 cm Rigid Riser

RIGID RISER MODEL CHART

Model	Description
RR12	30 cm rigid riser
RR12-T	30 cm rigid riser with ½" threaded base
RR12-B	30 cm rigid riser with 6 mm barb base

MICRO SPRAYS

Apply water accurately for small-area coverage.

SOLO-DRIP

- Eight streams of water for thorough coverage
- Adjustable cap for flow and radius adjustment



SOLO-DRIP PERFORMANCE DATA

Pressure (bar; kPa)	Flow (l/hr)	Throw Diameter (m)	
		360° x 18 Hole	180° 90°
1.0; 100	0-40	0-0.5	0-1.5
1.5; 150	0-50	0-0.6	0-2.1
2.0; 200	0-60	0-0.8	0-2.6

Note: Adjustable to maximum (approx. 20 clicks)

HALO-SPRAY

- Adjustable umbrella of water
- Adjustable cap for flow and radius adjustment



HALO-SPRAY PERFORMANCE DATA

Pressure (bar; kPa)	Flow (l/hr)	Throw Diameter (m)	
		360° x 18 Hole	180° 90°
1.0; 100	0-52	0-1.7	0-5.0
1.5; 150	0-65	0-2.8	0-5.8
2.0; 200	0-74	0-3.4	0-6.4

Note: Adjustable to maximum (approx. 14 clicks)

TRIO-SPRAY

- Full-, half-, and quarter-circle configurations
- Adjustable cap for flow and radius adjustment



TRIO-SPRAY PERFORMANCE DATA

Pressure (bar; kPa)	Flow (l/hr)	Spray Pattern (m)		
		Diameter in Throw 360° x 18 Hole	Radius of Throw 180°	90°
0.5; 50	0-54	0-5.0	0-2.0	0-1.5
1.0; 100	0-77	0-5.8	0-2.5	0-2.1
1.5; 150	0-94	0-6.4	0-2.9	0-2.6
2.0; 200	0-105	0-7.0	0-3.2	0-3.0
2.5; 250	0-119	0-7.5	0-3.5	0-3.3

PRODUCT SPECIFICATIONS

- Inlet configurations: 6 mm barb, 10-32 thread, 6 mm barb stake

OPERATING SPECIFICATIONS

- Pressure range: 0.5 to 2.5 bar; 50 to 250 kPa
- Minimum filtration: 100 mesh (150 microns)
- Warranty period: 1 year



SD-T



SD-B



SD-B-STK
Height: 15.2 cm



HS-T



HS-B



HS-B-STK
Height: 15.2 cm



TS-T-F



TS-T-H



TS-T-Q

B = Barbed, F = Full, H = Half, Q = Quarter, STK = Stake, T = Threaded



For a more robust overhead micro spray system, pair Short-Radius Micro Spray Nozzles with Pro-Spray™ Sprinkler Bodies.



Short-Radius
Micro Spray Nozzles

Page 191

MULTI-PURPOSE BOX

This sturdy box is just the right size to provide protection and easy access to essential irrigation components.

KEY BENEFITS

- Small footprint in a sturdy, durable box
- Five colour offerings blend in with any environment
- Overlapping lid prevents debris from entering box
- Knock-out bolt hole
- UV-protected, non-slip lid
- Warranty period: 2 years

PRODUCT SPECIFICATIONS

- Fits small control zone kits and other assorted components
- Durable HDPE construction
- $\frac{3}{8}$ " bolt included with every box



Multi-Purpose Box

Top
Width: 19.0 cm
Length: 26.7 cm

Bottom
Width: 21.6 cm
Length: 29.2 cm

Height: 20 cm



MB-LID-B



MB-LID-G



MB-LID



MB-LID-R



MB-LID-T

MULTI-PURPOSE BOX	
Model	Description
MB-0811	Multi-Purpose Box with standard brown lid
MB-0811-G	Multi-Purpose Box with green lid
MB-0811-T	Multi-Purpose Box with tan lid
MB-0811-R	Multi-Purpose Box with purple lid
MB-0811-B	Multi-Purpose Box with black lid
MB-BOX	Multi-Purpose Box (box only)
MB-LID	Multi-Purpose Box (lid only), brown
MB-LID-G	Multi-Purpose Box (lid only), green
MB-LID-T	Multi-Purpose Box (lid only), tan
MB-LID-R	Multi-Purpose Box (lid only), purple
MB-LID-B	Multi-Purpose Box (lid only), black

Multi-Purpose Box Installed



AIR/VACUUM RELIEF VALVE

Prevent water hammer and system collapse by discharging air during startup and allowing air to enter during shutdown.

KEY BENEFITS

- Releases air pockets without premature closure
- Leak-free closure after release
- Helps prevent system collapse through vacuum relief

PRODUCT SPECIFICATIONS

- UV-protected and corrosion-resistant material

OPERATING SPECIFICATIONS

- Pressure range: up to 5.5 bar; 550 kPa
- Warranty period: 2 years



AVR-075
Height: 13 cm
Width: 5 cm
Inlet: 3/4" MPT



PLD-AVR
1/2" Air/Vacuum Relief Valve

Air/Vacuum Relief Valve Installed



AUTOMATIC FLUSH VALVE

Keep laterals clean by automatically flushing water, air, and debris at each system startup.

KEY BENEFITS

- Flushes debris automatically at every system startup
- Reversible diaphragm to coordinate with low or high flow
- Lateral placement provides better grit tolerance

PRODUCT SPECIFICATIONS

- Removable top for diaphragm maintenance

OPERATING SPECIFICATIONS

- Pressure range: up to 4.1 bar; 410 kPa
- Low-flow diaphragm side: 7.6 to 18.9 l/m
- High-flow diaphragm side: 18.9 to 45.4 l/m
- Warranty period: 1 year



AFV-B
Automatic Flush Valve with
17 mm barb connection



AFV-T
Automatic Flush Valve with
1/2" MPT connection

Automatic Flush Valve Installed



A row of young green plants, possibly lupines, is growing in a garden bed covered with brown wood chip mulch. The plants are in various stages of growth, with some showing small buds. The background is slightly blurred, showing more plants and a wooden fence. The word "RECLAIMED" is overlaid in large, white, bold, sans-serif capital letters across the middle of the image, with a thin white horizontal line underneath it.

RECLAIMED



EMBRACE THE POWER OF PURPLE

with our complete line of reclaimed water products

ROTORS



PGJ	PGP™ ULTRA	I-20	I-25	I-40
PGJ-00-R	PGP-00-CV-R	I-20-00-R	I-25-04-B-R	I-40-04-SS-B-R
PGJ-04-R	PGP-00-CV-R-PRB	I-20-00-R-PRB	I-25-04-SS-B-R	I-40-04-SS-ON-B-R
PGJ-06-R	PGP-04-CV-R	I-20-04-R	I-25-06-B-R	I-40-06-SS-B-R
PGJ-12-R	PGP-04-CV-R-PRB	I-20-04-SS-R	I-25-06-SS-B-R	I-40-06-SS-ON-B-R
	PGP-06-CV-R	I-20-04-R-PRB		
	PGP-12-CV-R	I-20-04-SS-R-PRB		
		I-20-06-R		
		I-20-06-SS-R		
		I-20-06-R-PRB		
		I-20-06-SS-R-PRB		
		I-20-12-R		

Rotors Key

- 00 - Shrub
- 04 - 10 cm pop-up
- 06 - 15 cm pop-up
- 12 - 30 cm pop-up
- CV - Check valve
- SS - Stainless steel
- ON - Opposing nozzles
- PRB - Pressure-regulated body
- ARV - Adjustable arc
- 3RV - Full-circle
- RB - Reclaimed BSP

ROTORS



I-80	I-90
I-80-04-SS-R-B	I-90-ARV-B
I-80-04-SS-ON-R-B	I-90-3RV-B

SPRINKLER BODIES



PRO-SPRAY™	PRO-SPRAY PRS30	PRO-SPRAY PRS40
PROS-00-R	PROS-00-PRS30-R	PROS-00-PRS40-R
PROS-04-CV-R	PROS-04-PRS30-CV-R	PROS-04-PRS40-CV-R
PROS-06-CV-R	PROS-06-PRS30-CV-R	PROS-06-PRS40-CV-R
PROS-12-CV-R	PROS-12-PRS30-CV-R	PROS-12-PRS40-CV-R
PROS-RC-CAP-SP (snap-on)	PROS-04-PRS30-CV-F-R	PROS-04-PRS40-CV-F-R
458520SP = ID cap (threaded)	PROS-06-PRS30-CV-F-R	PROS-06-PRS40-CV-F-R
	PROS-12-PRS30-CV-F-R	PROS-12-PRS40-CV-F-R
	458560 = ID cap	458562 = ID cap

Sprays Key

- 00 - Shrub
- 04 - 10 cm pop-up
- 06 - 15 cm pop-up
- 12 - 30 cm pop-up
- CV - Check valve
- F - FloGuard™ Technology

RECLAIMED

BUBBLERS



BUBBLERS

- PCB-25-R
- PCB-50-R
- PCB-10-R
- PCB-20-R

Bubblers Key

25 - 0.9 l/min 10 - 3.8 l/min
 50 - 1.9 l/min 20 - 7.6 l/min

VALVES



ICV VALVE

- ICV-151G-B-FS-R
- ICV-201G-B-FS-R
- 561205 = ICV-101-201 series ID handle
- 515005 = ICV-301 series ID handle

Valves Key

B - BSP threads
 FS - Filter Sentry™ Mechanism
 LRC - Locking rubber cover
 RC - Rubber cover
 AW - Acme key with anti-rotation wheels

* Note: IBV purple tags are user-installed options.



IBV VALVE

- IBV-151G-B-FS-R
- IBV-201G-B-FS-R



QUICK COUPLERS

- HQ-33-DLRC-R
- HQ-44-LRC-R
- HQ-44-LRC-AW-R
- HQ-5-LRC-R
- HHQ-5-LRC-BSP-R

Quick Couplers Key

LRC - Locking rubber cover
 RC - Rubber cover
 AW - Acme key with anti-rotation wheels

MICRO



IH RISERS

- IH-RISER-XX-R
- IH-FIT-3850-R



ROOT ZONE WATERING SYSTEM

- | | |
|-----------------|----------------------------------|
| RZWS-10-R | RZWS-36-R |
| RZWS-10-25-R | RZWS-36-25-R |
| RZWS-10-50-R | RZWS-36-50-R |
| RZWS-10-25-CV-R | RZWS-36-25-CV-R |
| RZWS-10-50-CV-R | RZWS-36-50-CV-R |
| RZWS-18-R | 913301SP |
| RZWS-18-25-R | (purple cap for 45 cm and 90 cm) |
| RZWS-18-50-R | RZWS-10-RCC |
| RZWS-18-25-CV-R | (purple cap for 25 cm) |
| RZWS-18-50-CV-R | |



HUNTER DRIPLINE

- HDL-06-12-250-R
- HDL-06-12-1K-R
- HDL-06-18-250-R
- HDL-06-18-1K-R
- HDL-09-12-250-R
- HDL-09-12-1K-R
- HDL-09-18-250-R
- HDL-09-18-1K-R
- HDL-BLNK-500-R



ECO-INDICATOR

- ECO-ID-12-R



MULTI-PURPOSE BOX

- MB-0811-R
- MB-LID-R (lid only)

Micro Key

IH Risers

XX - Riser Length 18 - 45 cm
 06 - 15 cm 24 - 60 cm
 12 - 30 cm 36 - 90 cm

RZWS

10 - 25 cm 25 - 0.9 l/min
 18 - 45 cm 50 - 1.9 l/min
 36 - 90 cm CV - Check valve

HDL

BLNK - No emitter HDL-09 - 3.4 l/hr 24 - 24 cm 1K - 300 m
 HDL-04 - 1.5 l/hr 12 - 12 cm 250 - 75 m
 HDL-06 - 2.1 l/hr 18 - 18 cm 500 - 150 m



TOOLS

SPOTSHOT HOSE-END NOZZLE

MODELS

- ¾" hose thread inlet - P/N 160700
- 1" (25 mm) hose thread inlet - P/N 160705

KEY BENEFITS

- Variable nozzle stream choices:
 - Fan: Broad, light stream for turf hot spots
 - Soak: Medium stream for dust-control areas
 - Jet: Tight, focused stream for power washing

OPERATING SPECIFICATIONS

- Flow: 132 l/min; 8 m³/hr at 5.5 bar; 551 kPa*
- * Not recommended for residential use with regulated, low-pressure, or low-flow conditions



SpotShot Hose-End Nozzle

¾" P/N 160700SP
1" (25 mm) P/N 160705



Pitot Gauge

P/N 280100SP
Used to check operating pressure of rotor sprinklers



MP Gauge Assembly

P/N MPGAUGE
Used to check operating pressure on spray body sprinklers



Hand Pump

P/N 217500SP
Used to remove water from flooded areas during service and installation



Nozzle Insertion Collar

P/N 123200SP



Hunter Wrench

P/N 172000SP



T-Handle Tool

P/N 319100SP



Nozzle Removal/ Installation Tool

P/N 803700SP
13 mm Nut Driver used with I-80 Rotor short and mid-range nozzles



Snap Ring Removal Tool

P/N 251000SP
Use with I-80 Rotor

RESOURCES

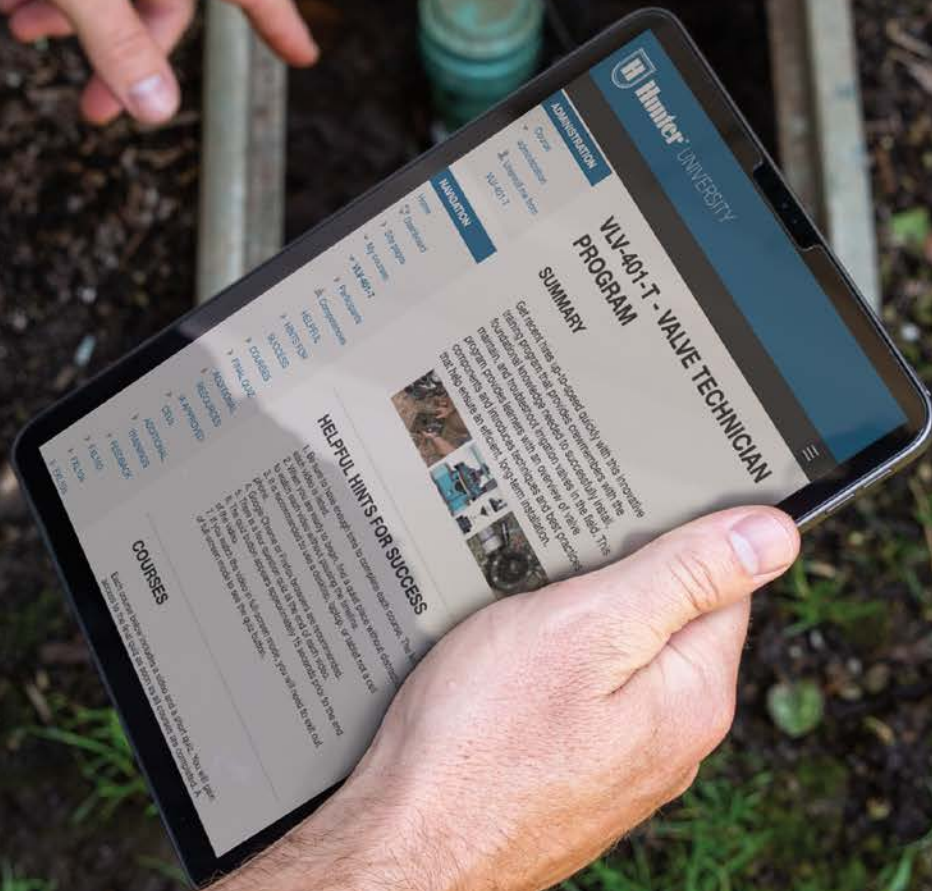

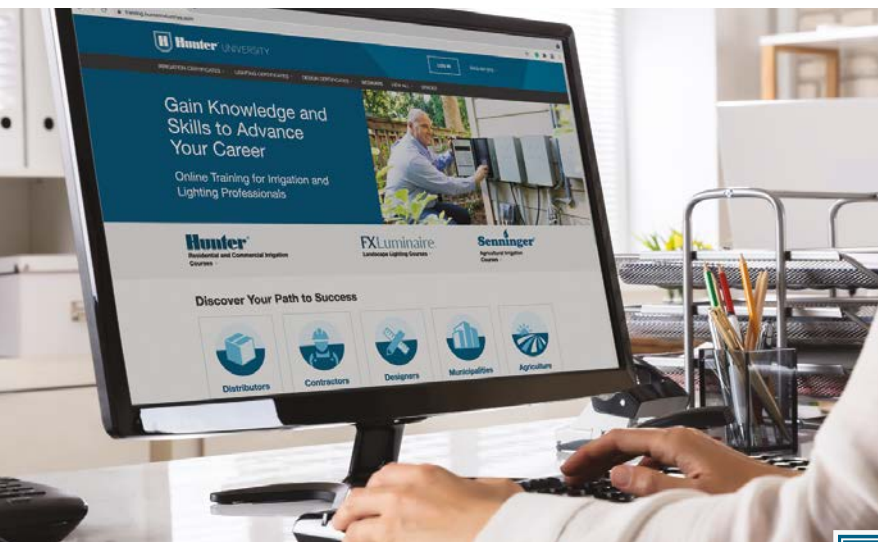

HUNTER UNIVERSITY

hunter.info/hunteruniversityem

Advance your career with our comprehensive online training certificate programs for irrigation professionals. From fundamental product knowledge to advanced control systems and design techniques, there's a professional development programs waiting for you! Learn more at training.hunterindustries.com.

Find Your Path to Success

1. Access free online product training at training.hunterindustries.com.
2. Choose the programs or courses that best fit your needs.

Earn certificates and badges to show off your expertise and receive continuing education credits from the Irrigation Association to meet professional requirements.

On-Site Expert Workshops

These interactive, instructor-led courses feature a hands-on approach to learning. Classes are held at the Hunter campus in San Marcos, California, and select locations worldwide. To learn more, contact training@hunterindustries.com.

Learn Hands-On Fundamentals!

Irrigation Installation Fundamentals

For reliable long-term performance, all irrigation system components must be installed correctly. Learn installation best practices today.

Irrigation Certificate Programmes

- Product Specialist (Core and Advanced)
- Irrigation Designer
- Hydrowise™ Specialist
- X2™ Specialist
- Irrigation Installation Fundamentals
- Valve Technician ◆ NEW
- S.T.A.R. Distributor
- EZ Decoder System Specialist ◆ NEW
- EZ Decoder System Technician ◆ NEW

WORLD-CLASS EDUCATION, TOOLS, AND SUPPORT

For Green Industry Professionals

As your partner in business development, we know you need more than top-quality products to increase profits, provide excellent customer service, and stand out against the competition. We're proud to provide a full suite of free tools, services, and programmes to help irrigation professionals of all backgrounds succeed. Learn more at hunter.direct/tools.



THE VAULT

vault.hunterindustries.com

Learn new facts, complete tasks to earn coins, and redeem your coins for prizes. Check back each week to see what's new.



WATER SAVINGS CALCULATOR

hunter.info/savingscalem

Show your customers how much water — and money — they can save by upgrading to a more efficient irrigation system.



SITEREC APP

hunter.info/siterecem

Close sales faster! Confidently present proposals to your customers. Add your logo and business details for a professional presentation.



RUN TIME CALCULATOR

hunter.info/runtimeem

Use this helpful calculator to generate the most efficient irrigation schedule for every landscape and prevent wasteful runoff.



MY LIST

hunter.info/mylistem

Build customised product lists for every project. Email lists to distributors for faster ordering and add pricing and notes to each project.



DRIPLINE CALCULATOR

hunter.info/driplem

Eliminate guesswork with this handy tool. See site recommendations, determine product quantities, and calculate run times in a simple format.



CAD LEGENDS

hunter.info/cadlegendsem

To help you complete projects accurately in CAD software, we offer a range of irrigation legends that show proper specification.



VIRTUAL ENGAGEMENT CENTER

vec.hunterindustries.com

Learn about our latest irrigation products in a fun, informative, and immersive digital space.



CAD DETAILS

hunter.info/caddetailsem

To streamline the irrigation design process, we provide installation CAD details in PDF, DWG, and DXF formats.



SITE STUDY LIBRARY

hunter.info/sitestudyem

See how Hunter irrigation products have transformed parks, sports fields, and outdoor living spaces around the world.



BIM 3D MODELS

hunter.info/bimmodelsem

BIM uses advanced 3D modelling to develop irrigation specification documents. Find BIM-supported products for your next project.



VIDEO LIBRARY

hunter.info/vidiolibraryem

Visit our comprehensive video library to discover key product benefits, hear from experts, find installation tips, and more.

FOLLOW US TO STAY ON TOP OF OUR LATEST PRODUCT NEWS, PROMOTIONS, INSTALLATION TIPS, AND MORE!



PRECIPITATION RATES



In this section, the “Sprinkler Spacing Method – Any Arc and Any Spacing” equation is used to calculate precipitation rates. The first set of equations with the ■ shows the precipitation rate for the sprinklers when they are laid out in a square pattern. The next set with the ▲ shows the precipitation rate for the sprinklers laid out in an equilateral triangular spacing pattern. This is the “Sprinkler Spacing Method – Equilateral Triangular Spacing” equation.

WHAT IS PRECIPITATION RATE?

If someone said they were caught in a rainstorm that dropped 25 mm of water in an hour, you would have some idea of how hard or heavily the rain came down. A rainstorm that covers an area with 25 mm of water in one hour has a precipitation rate of 25 mm per hour. Similarly, the precipitation rate is the speed at which a sprinkler or an irrigation system applies water.

MATCHED PRECIPITATION RATES

A zone or system in which all the heads have similar precipitation rates is said to have “matched precipitation rates.” Systems that have matched precipitation rates reduce wet and dry spots and minimise run times, which reduces water consumption and lowers costs. Knowing that sprinkler spacing, flow rates, and arcs of coverage affect precipitation rates, a general guideline is: as the spray arc doubles, so should the flow.

	90° Arc = 1 GPM; 0.23 m ³ /hr; 3.8 l/min		180° Arc = 2 GPM; 0.45 m ³ /hr; 7.6 l/min		360° Arc = 4 GPM; 0.91 m ³ /hr; 15.1 l/min
--	--	---	---	---	--

The flow rate of half-circle heads must be two times the flow rate of the quarter-circle heads, and the full-circle heads must have two times the flow rate of the half-circle heads. In the illustration, the same amount of water is applied to each quarter circle area and precipitation is therefore matched.

CALCULATING PRECIPITATION RATES

Depending upon the construction of the irrigation system, the precipitation rate may be calculated by either a Sprinkler Spacing or a Total Area method.

Sprinkler Spacing Method (■)

The precipitation rate should be calculated for each individual zone. If all sprinkler heads on the zone have the same spacing, flow rate, and arc of coverage, use one of the following formulas:

Any Arc and Any Spacing (■):

$$\begin{aligned} \text{P.R. (in/hr)} &= \frac{\text{Flow Rate (GPM) for any Arc} \times 34,650}{\text{Degrees of Arc} \times \text{Head Spacing (ft.)} \times \text{Row Spacing (ft.)}} \\ \text{P.R. (mm/hr)} &= \frac{\text{Flow Rate (m}^3\text{/hr) for any Arc} \times 360,000}{\text{Degrees of Arc} \times \text{Head Spacing (m)} \times \text{Row Spacing (m)}} \\ \text{P.R. (mm/hr)} &= \frac{\text{Flow Rate (l/min) for any Arc} \times 21,600}{\text{Degrees of Arc} \times \text{Head Spacing (m)} \times \text{Row Spacing (m)}} \end{aligned}$$

Sprinkler Spacing Method (▲)

The precipitation rate should be calculated for each individual zone. If all sprinkler heads on the zone have the same spacing, flow rate, and arc of coverage, use one of the following formulas:

Equilateral Triangular Spacing (▲):

$$\begin{aligned} \text{P.R. (in/hr)} &= \frac{\text{Flow Rate (GPM) for any Arc} \times 34,650}{\text{Degrees of Arc} \times (\text{Head Spacing})^2 \times 0.866} \\ \text{P.R. (mm/hr)} &= \frac{\text{Flow Rate (m}^3\text{/hr) for any Arc} \times 360,000}{\text{Degrees of Arc} \times (\text{Head Spacing})^2 \times 0.866} \\ \text{P.R. (mm/hr)} &= \frac{\text{Flow Rate (l/min) for any Arc} \times 21,600}{\text{Degrees of Arc} \times (\text{Head Spacing})^2 \times 0.866} \end{aligned}$$

Total Area Method

The precipitation rate for a “system” is the average precipitation rate of all sprinklers in an area, regardless of the spacing, flow rate, or arc for each head. The Total Area Method calculates all the flows of all of the heads in any given area.

$$\begin{aligned} \text{P.R. (in/hr)} &= \frac{\text{Flow (GPM)} \times 96.25}{\text{Total Area (ft.)}} \\ \text{P.R. (mm/hr)} &= \frac{\text{Flow (m}^3\text{/hr)} \times 1,000}{\text{Total Area (m}^2\text{)}} \\ \text{P.R. (mm/hr)} &= \frac{\text{Flow (l/min)} \times 60}{\text{Total Area (m}^2\text{)}} \end{aligned}$$

SLOPE EQUIVALENTS/IRRIGATION

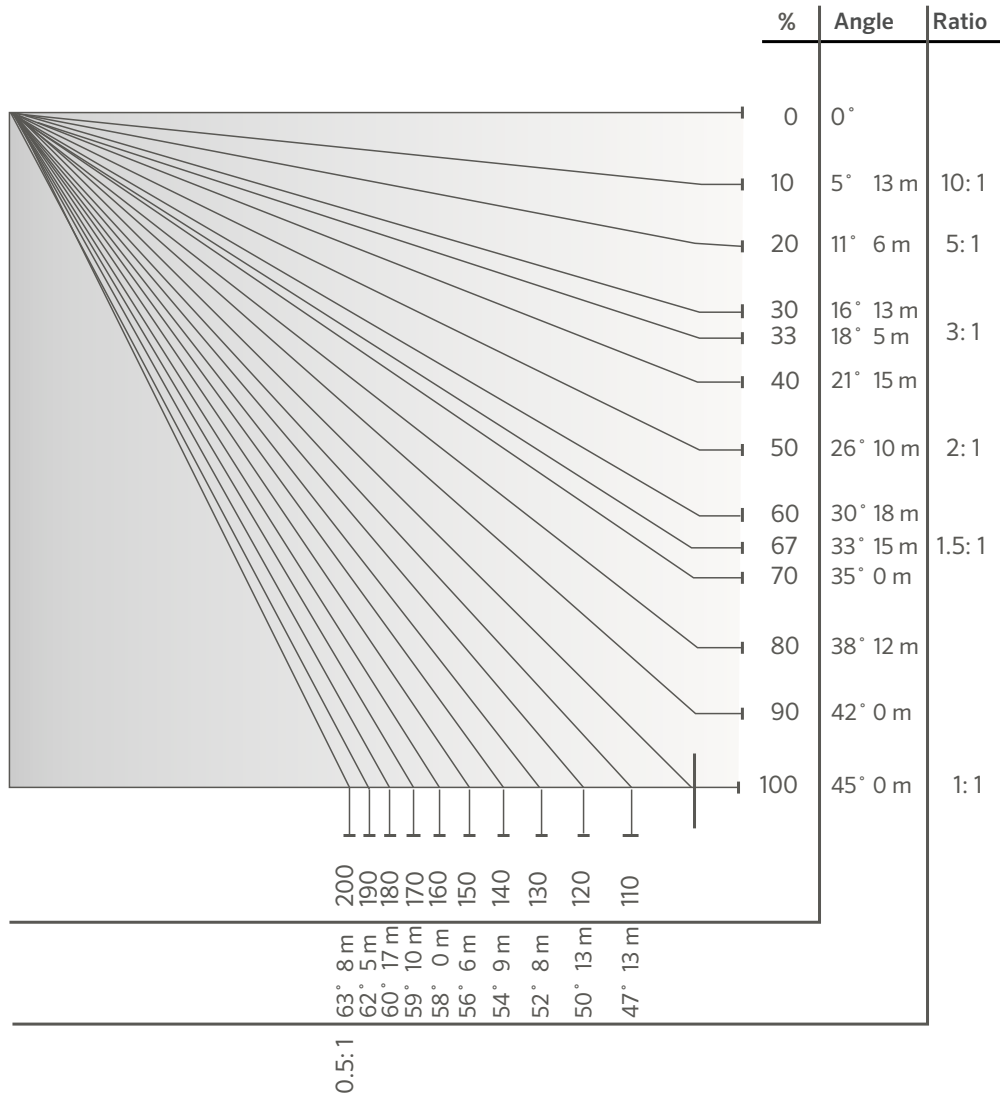

SLOPE IRRIGATION: Maximum precipitation rates for slopes in mm/hr

Soil Texture	0 to 5% Slope		5 to 8% Slope		8 to 12% Slope		12%+ Slope	
	Cover	Bare	Cover	Bare	Cover	Bare	Cover	Bare
Coarse sandy soils	51	51	51	38	38	25	25	13
Coarse sandy soils over compact subsoils	44	38	32	25	25	19	19	10
Light sandy loams uniform	44	25	32	20	25	15	19	10
Light sandy loams over compact subsoils	32	19	25	13	19	10	13	8
Uniform silt loams	25	13	20	10	15	8	10	5
Silt loams over compact subsoil	15	8	13	6	10	4	8	3
Heavy clay or clay loam	5	4	4	3	3	2	3	2

Notes:

The maximum precipitation values listed below are those suggested by the United States Department of Agriculture. The values are average and may vary with respect to actual soil and groundcover conditions.

HEIGHT OF SPRAY

When designing and installing irrigation systems, it's important to know the trajectory and spray height of the water stream leaving the nozzle.

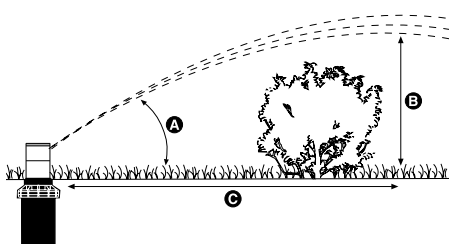

These rotor nozzle trajectory charts are designed to help determine how close a sprinkler can be placed to an object such as a fence or hedge without obstructing the spray pattern. All information shown is at optimum operating pressures.

HUNTER NOZZLE HEIGHT AND TRAJECTORY CHART

Model	Nozzle No.	Pressure		Degrees of Trajectory	Max Height of Spray (m)	Distance from Head to Maximum Height (m)
		bar	kPa			
MP ROTATOR™	800SR	2.8	280	18	0.5	Varies
	815	2.8	280	15	0.3	Varies
	1000	2.8	280	20	0.5	Varies
	2000	2.8	280	26	1.1	Varies
	3000	2.8	280	26	2.0	Varies
	3500	2.8	280	28	2.5	Varies
	Corner	2.8	280	14	0.4	Varies
	Side Strip	2.8	280	16	0.5	Varies
	Left Strip	2.8	280	16	0.5	Varies
PGJ/SRM	0.50	2.8	280	10	0.6	1.2
	0.75	2.8	280	10	0.6	1.2
	1.0	2.8	280	10	0.6	2.4
	1.5	2.8	280	10	0.9	3.7
	2.0	2.8	280	15	1.5	4.9
	2.5	2.8	280	12	1.5	6.1
	3.0	2.8	280	15	1.5	6.1
	4.0	2.8	280	15	1.5	6.7
PGP™ RED NOZZLES	1.0	3.5	350	26	2.1	6.7
	2.0	3.5	350	26	2.1	6.7
	3.0	3.5	350	26	2.4	7.0
	4.0	3.5	350	26	2.4	7.0
	5.0	3.5	350	27	2.7	7.9
	6.0	3.5	350	27	3.0	8.5
	7.0	3.5	350	26	3.4	9.1
	8.0	3.5	350	26	3.4	9.1
	9.0	3.5	350	27	3.7	9.8
	10.0	4.0	400	25	4.0	9.8
	11.0	4.0	400	25	4.0	11.6
12.0	4.0	400	25	4.0	12.2	
PGP LOW-ANGLE GREY NOZZLES	4.0	3.5	350	15	1.5	6.7
	5.0	3.5	350	15	1.2	6.7
	6.0	3.5	350	14	1.2	6.7
	7.0	3.5	350	14	1.2	6.7
	8.0	3.5	350	14	1.5	7.3
	9.0	3.5	350	15	1.5	7.9
PGP BLUE NOZZLES	10.0	4.0	400	15	1.8	9.1
	1.5	3.0	300	25	2.4	7.0
	2.0	3.0	300	25	2.4	7.0
	2.5	3.0	300	25	2.7	7.9
	3.0	3.0	300	25	3.0	8.5
	4.0	3.0	300	25	3.4	9.1
	5.0	3.0	300	25	3.4	9.1
	6.0	3.8	380	25	3.7	9.8
8.0	3.8	380	25	4.0	9.8	
PGP ULTRA/I-20 DARK BLUE NOZZLES	1.0	3.5	350	26	2.4	7.0
	1.5	3.5	350	26	2.4	7.0
	2.0	3.5	350	27	2.7	7.9
	3.0	3.5	350	27	3.0	8.5
	3.5	3.5	350	26	3.4	9.1
	4.0	3.5	350	26	3.4	9.1
	6.0	3.5	350	27	3.7	9.8
	8.0	4.0	400	25	4.0	9.8
PGP ULTRA/I-20 BLUE NOZZLES	1.5	3.0	300	25	2.4	7.0
	2.0	3.0	300	25	2.4	7.0
	2.5	3.0	300	25	2.7	7.9
	3.0	3.0	300	25	3.0	8.5
	4.0	3.0	300	25	3.4	9.1
	5.0	3.0	300	25	3.4	9.1
	6.0	3.8	380	25	3.7	9.8
	8.0	3.8	380	25	4.0	9.8

HEIGHT OF SPRAY

HUNTER NOZZLE HEIGHT AND TRAJECTORY CHART						
Model	Nozzle No.	Pressure		Degrees of Trajectory	Max Height of Spray (m)	Distance from Head to Maximum Height (m)
		bar	kPa			
PGP™ Ultra/I-20 Low-Angle Grey Nozzles	2.0 LA	3.5	350	13	1.5	6.7
	2.5 LA	3.5	350	13	1.2	6.7
	3.5 LA	3.5	350	13	1.2	6.7
	4.5 LA	3.5	350	13	1.2	6.7
PGP Ultra/I-20 Short Radius Black Nozzles	0.5	3.5	350	15	1.5	2.4
	1.0	3.5	350	14	1.8	2.7
	2.0	3.5	350	3	0.3	1.8
PGP Ultra/I-20 Short Radius Black Nozzles	0.75	3.5	350	22	2.1	4.0
	1.5	3.5	350	18	2.1	4.0
	3.0	3.5	350	8	0.3	1.8
PGP Ultra/I-20 MPR-25 Red Nozzles	Q - 90	3.0	300	22	0.9	4.6
	T - 120	3.0	300	21	1.2	4.2
	H - 180	3.0	300	24	1.2	4.2
	F - 360	3.0	300	22	1.2	3.0
PGP Ultra/I-20 MPR-30 Lt. Green Nozzles	Q - 90	3.0	300	28	1.5	5.4
	T - 120	3.0	300	14	0.9	5.1
	H - 180	3.0	300	16	1.2	4.8
	F - 360	3.0	300	18	0.6	3.9
PGP Ultra/I-20 MPR-35 Tan Nozzles	Q - 90	3.0	300	28	1.8	5.7
	T - 120	3.0	300	28	1.8	5.4
	H - 180	3.0	300	16	1.2	5.1
	F - 360	3.0	300	14	0.9	3.6
I-25	4	3.5	350	25	2.7	6.7
	7	3.5	350	25	3.0	8.5
	8	3.5	350	25	3.4	8.5
	10	4	400	25	3.7	9.1
	13	4	400	25	4.0	9.4
	15	4	400	25	3.7	9.4
	18	4	400	25	4.6	10.4
	20	5	500	25	4.6	10.7
	23	5	500	25	4.9	11.6
	25	5	500	25	4.9	11.6
I-40 Adjustable	8	3.5	350	25	3.7	9.8
	10	4.0	400	25	4.3	9.8
	13	4.0	400	25	4.3	10.4
	15	4.0	400	25	4.6	12.8
	23	5.0	500	25	5.2	14.0
I-40-ON	25	5.0	500	25	5.2	14.6
	15	4.0	400	25	4.6	12.8
	18	4.0	400	25	4.8	13.1
	20	5.0	500	25	5.2	13.7
	23	5.0	500	25	5.2	14.0
25	5.0	500	25	5.2	14.6	
28	5.0	500	25	5.2	15.2	

HEIGHT OF SPRAY

HUNTER NOZZLE HEIGHT AND TRAJECTORY CHART

Model	Nozzle No.	Pressure		Degrees of Trajectory	Max Height of Spray (m)	Distance from Head to Maximum Height (m)
		bar	kPa			
I-80 & I-90 ADV	23	5.5	550	22.5	4.3	11.3
	25	5.5	550	22.5	4.6	12.2
	33	5.5	550	22.5	4.6	12.8
	38	5.5	550	22.5	4.9	14.6
	43	5.5	550	22.5	4.9	14.6
	48	5.5	550	22.5	5.2	16.5
	53	5.5	550	22.5	5.2	17.1
	63	5.5	550	22.5	5.5	19.5
	73	5.5	550	22.5	5.8	20.7
I-80-ON & I-90 36V	23	5.5	550	22.5	4.3	12.5
	25	5.5	550	22.5	4.6	14.0
	33	5.5	550	22.5	4.6	14.0
	38	5.5	550	22.5	4.9	15.3
	43	5.5	550	22.5	4.9	16.5
	48	5.5	550	22.5	5.2	17.1
	53	5.5	550	22.5	5.2	17.7
	63	5.5	550	22.5	5.5	18.9
	73	5.5	550	22.5	5.8	20.7

HDL MAXIMUM RUN LENGTHS

HDL-CV; 1.5 l/hr

Pressure (bar; kPa)	Emitter Spacing (cm)		
	30	45	60
1.0; 100	62	88	112
2.0; 200	116	163	207
3.0; 300	142	200	255
4.0; 400	161	228	289

HDL-CV; 2.1 l/hr

Pressure (bar; kPa)	Emitter Spacing (cm)		
	30	45	60
1.0; 100	52	73	93
2.0; 200	96	134	171
3.0; 300	117	166	210
4.0; 400	134	189	239

HDL-CV; 3.4 l/hr

Pressure (bar; kPa)	Emitter Spacing (cm)		
	30	45	60
1.0; 100	36	50	64
2.0; 200	66	94	119
3.0; 300	81	115	146
4.0; 400	92	131	165

HDL-PC/HDL-R; 1.5 l/hr

Pressure (bar; kPa)	Emitter Spacing (cm)		
	30	45	60
1.0; 100	87	123	156
2.0; 200	125	177	224
3.0; 300	149	210	266
4.0; 400	167	235	299

HDL-PC/HDL-R; 2.1 l/hr

Pressure (bar; kPa)	Emitter Spacing (cm)		
	30	45	60
1.0; 100	72	101	129
2.0; 200	103	147	186
3.0; 300	123	174	220
4.0; 400	137	194	247

HDL-PC/HDL-R; 3.4 l/hr

Pressure (bar; kPa)	Emitter Spacing (cm)		
	30	45	60
1.0; 100	50	71	89
2.0; 200	72	101	128
3.0; 300	85	120	153
4.0; 400	96	134	171

HDL-COP; 2.1 l/hr

Pressure (bar; kPa)	Emitter Spacing (cm)	
	30	45
1.0; 100	52	73
2.0; 200	96	134
3.0; 300	117	166
4.0; 400	134	189

HDL-COP; 3.4 l/hr

Pressure (bar; kPa)	Emitter Spacing (cm)	
	30	45
1.0; 100	36	50
2.0; 200	66	94
3.0; 300	81	115
4.0; 400	92	131

MLD FLOW CHART

MLD FLOW CHART

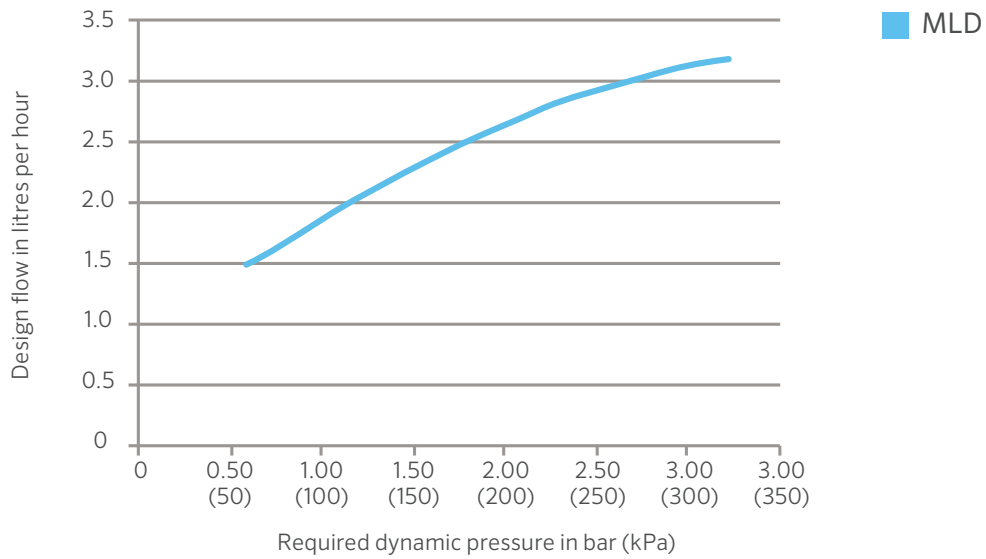

CONVERSION FACTORS

CONVERSION FACTORS			
To Convert	From	To	Multiply By
Area	acres	foot ²	43560
	acres	metre ²	4046.8
	metre ²	foot ²	10.764
	foot ²	inch ²	144
	inch ²	centimetre ²	6.452
	hectares	metre ²	10000
	hectares	acres	2.471
Power	kilowatts	horsepower	1.341
Flow	foot ³ /minute	metre ³ /second	0.0004719
	foot ³ /second	metre ³ /second	0.02832
	yards ³ /minute	metre ³ /second	0.01274
	gallon/minute	metre ³ /hour	0.22716
	gallon/minute	litre/minute	3.7854
	gallon/minute	litre/second	0.06309
	metre ³ /hour	litre/minute	16.645
	metre ³ /hour	litre/second	0.2774
	litre/minute	litre/second	60
Length	foot	inch	12
	inch	centimetre	2.54
	foot	metre	0.30481
	kilometre	miles	0.6214
	miles	foot	5280
	miles	metre	1609.34
	millimetre	inch	0.03937
Pressure	PSI	kilopascals	6.89476
	PSI	bar	0.068948
	bar	kilopascals	100
	PSI	feet of head	2.31
Velocity	feet/second	metre/second	0.3048
Volume	feet ³	gallon	7.481
	feet ³	litre	28.32
	metre ³	feet ³	35.31
	metre ³	yard ³	1.3087
	yard ³	feet ³	27
	yard ³	gallon	202
	acres/feet	foot ³	43,560
	gallon	metre ³	0.003785
	gallon	litre	3.785
	imperial gallon	gallon	1.833

FRICION LOSS CHARTS - UPVC PIPE CLASS 3 (6 BAR)

C = 150 • PRESSURE LOSS (BAR/100 METRES)

Nominal Size		40 mm		50 mm		63 mm		75 mm		90 mm		110 mm		160 mm		200 mm	
Pipe ID		36.4 mm		46.4 mm		59.2 mm		70.6 mm		84.6 mm		103.6 mm		153.2 mm		188.2 mm	
Pipe OD		40 mm		50 mm		63 mm		75 mm		90 mm		110 mm		160 mm		200 mm	
Wall Thick		1.8 mm		1.8 mm		1.9 mm		2.2 mm		2.7 mm		3.2 mm		3.4 mm		5.9 mm	
Flow l/min	Flow m ³ /hr	Velocity m/s	bar loss	Velocity m/s	bar loss	Velocity m/s	bar loss	Velocity m/s	bar loss	Velocity m/s	bar loss	Velocity m/s	bar loss	Velocity m/s	bar loss	Velocity m/s	bar loss
3.8	0.25																
7.6	0.5																
11.4	0.75																
15.1	1	0.3	0.03														
26.5	1.5	0.4	0.06	0.2	0.02												
34.1	2	0.5	0.09	0.3	0.03												
41.6	2.5	0.7	0.14	0.4	0.04												
49.2	3	0.8	0.20	0.5	0.06												
56.8	3.5	0.9	0.27	0.6	0.08												
68.1	4	1.1	0.34	0.7	0.10												
83.3	5	1.3	0.52	0.8	0.16												
98.4	6	1.6	0.72	1.0	0.22	0.6	0.07	0.4	0.03								
117.3	7	1.9	0.96	1.1	0.30	0.7	0.09	0.5	0.04								
132.5	8	2.1	1.23	1.3	0.38	0.8	0.12	0.6	0.05								
151.4	9	2.4	1.53	1.5	0.47	0.9	0.14	0.6	0.06								
166.6	10	2.7	1.86	1.6	0.57	1.0	0.17	0.7	0.07								
181.7	11			1.8	0.68	1.1	0.21	0.8	0.09	0.5	0.04						
200.6	12			2.0	0.8	1.2	0.24	0.9	0.10	0.6	0.04						
215.8	13			2.1	0.93	1.3	0.28	0.9	0.12	0.6	0.05						
234.7	14			2.3	1.07	1.4	0.33	1.0	0.14	0.7	0.06						
249.8	15			2.5	1.21	1.5	0.37	1.1	0.16	0.7	0.06	0.5	0.02				
265.0	16					1.6	0.42	1.1	0.18	0.8	0.07	0.5	0.03				
283.9	17					1.7	0.47	1.2	0.20	0.8	0.08	0.6	0.03				
299.0	18					1.8	0.52	1.3	0.22	0.9	0.09	0.6	0.03				
318.0	19					1.9	0.57	1.3	0.24	0.9	0.10	0.6	0.04				
333.1	20					2.0	0.63	1.4	0.27	1.0	0.11	0.7	0.04				
348.3	21					2.1	0.69	1.5	0.29	1.0	0.12	0.7	0.05				
367.2	22					2.2	0.75	1.6	0.32	1.1	0.13	0.7	0.05				
382.3	23					2.3	0.82	1.6	0.35	1.1	0.14	0.8	0.05				
401.3	24							1.7	0.37	1.2	0.16	0.8	0.06				
416.4	25							1.8	0.40	1.2	0.17	0.8	0.06				
431.5	26							1.8	0.43	1.3	0.18	0.9	0.07				
450.5	27							1.9	0.47	1.3	0.19	0.9	0.07				
465.6	28							2.0	0.50	1.4	0.21	0.9	0.08				
484.5	29							2.1	0.53	1.4	0.22	1.0	0.08				
499.7	30							2.1	0.57	1.5	0.23	1.0	0.09				
583.0	35									1.7	0.31	1.2	0.12				
666.2	40									2.0	0.40	1.3	0.15				
749.5	45									2.2	0.50	1.5	0.19				
832.8	50											1.6	0.23				
916.1	55											1.8	0.27				
999.3	60											2.0	0.32				
1082.6	65											2.1	0.37	1.0	0.05		
1165.9	70											2.3	0.42	1.1	0.06		
1249.2	75													1.1	0.07		
1332.5	80													1.2	0.08		
1415.7	85													1.3	0.09		
1499.0	90													1.4	0.10		
1665.6	100													1.5	0.12	1.0	0.04
1832.1	110													1.7	0.14	1.1	0.05
1998.7	120													1.8	0.17	1.2	0.06
2165.3	130													2.0	0.20	1.3	0.07
2331.8	140													2.1	0.23	1.4	0.08
2498.4	150													2.3	0.26	1.5	0.09

Notes: Shaded areas represent velocities over 1.5 m/s. Use with caution when water hammer is a concern.

FRICITION LOSS CHARTS - UPVC PIPE CLASS 4 (10 BAR)

C = 150 • PRESSURE LOSS (BAR/100 METRES)																					
Nominal Size		25 mm		32 mm		40 mm		50 mm		63 mm		75 mm		90 mm		110 mm		160 mm		200 mm	
Pipe ID		22 mm		28.4 mm		36.2 mm		45.2 mm		57 mm		67.8 mm		81.4 mm		99.4 mm		144.6 mm		180.8 mm	
Pipe OD		25 mm		32 mm		40 mm		50 mm		63 mm		75 mm		90 mm		110 mm		160 mm		200 mm	
Wall Thick		1.5 mm		1.8 mm		1.9 mm		2.4 mm		3.0 mm		3.6 mm		4.3 mm		5.3 mm		7.7 mm		9.6 mm	
Flow l/min	Flow m ³ /hr	Velocity m/s	bar loss	Velocity m/s	bar loss	Velocity m/s	bar loss	Velocity m/s	bar loss	Velocity m/s	bar loss	Velocity m/s	bar loss	Velocity m/s	bar loss	Velocity m/s	bar loss	Velocity m/s	bar loss	Velocity m/s	bar loss
3.8	0.25	0.2	0.02																		
7.6	0.5	0.4	0.08																		
11.4	0.75	0.5	0.18																		
15.1	1	0.7	0.30																		
26.5	1.5	1.1	0.64	0.7	0.19																
34.1	2	1.5	1.10	0.9	0.32																
41.6	2.5	1.8	1.66	1.1	0.48	0.7	0.15														
49.2	3	2.2	2.33	1.3	0.67	0.8	0.21														
56.8	3.5	2.6	3.10	1.5	0.89	0.9	0.27														
68.1	4			1.8	1.14	1.1	0.35	0.7	0.12												
83.3	5			2.2	1.73	1.3	0.53	0.9	0.18												
98.4	6			2.6	2.42	1.6	0.74	1.0	0.25	0.7	0.08										
117.3	7					1.9	0.99	1.2	0.34	0.8	0.11										
132.5	8					2.2	1.27	1.4	0.43	0.9	0.14										
151.4	9					2.4	1.58	1.6	0.53	1.0	0.17	0.7	0.07								
166.6	10							1.7	0.65	1.1	0.21	0.8	0.09								
181.7	11							1.9	0.77	1.2	0.25	0.8	0.11								
200.6	12							2.1	0.91	1.3	0.29	0.9	0.13								
215.8	13							2.3	1.06	1.4	0.34	1.0	0.15								
234.7	14							2.4	1.21	1.5	0.39	1.1	0.17								
249.8	15							2.6	1.38	1.6	0.44	1.2	0.19								
265.0	16									1.7	0.50	1.2	0.22	0.9	0.09						
283.9	17									1.9	0.56	1.3	0.24	0.9	0.10						
299.0	18									2.0	0.62	1.4	0.27	1.0	0.11						
318.0	19									2.1	0.69	1.5	0.30	1.0	0.12						
333.1	20									2.2	0.76	1.5	0.33	1.1	0.13						
348.3	21									2.3	0.83	1.6	0.36	1.1	0.15						
367.2	22									2.4	0.90	1.7	0.39	1.2	0.16						
382.3	23									2.5	0.98	1.8	0.42	1.2	0.17						
401.3	24											1.8	0.46	1.3	0.19						
416.4	25											1.9	0.49	1.3	0.20						
431.5	26											2.0	0.53	1.4	0.22	0.9	0.08				
450.5	27											2.1	0.57	1.4	0.23	1.0	0.09				
465.6	28											2.2	0.61	1.5	0.25	1.0	0.09				
484.5	29											2.2	0.65	1.5	0.27	1.0	0.10				
499.7	30											2.3	0.69	1.6	0.28	1.1	0.11	0.5	0.02		
583.0	35													1.9	0.38	1.3	0.14	0.6	0.02		
666.2	40													2.1	0.48	1.4	0.18	0.7	0.03		
749.5	45													2.4	0.60	1.6	0.23	0.8	0.04		
832.8	50															1.8	0.28	0.8	0.04		
916.1	55															2.0	0.33	0.9	0.05		
999.3	60															2.1	0.39	1.0	0.06		
1082.6	65															2.3	0.45	1.1	0.07		
1165.9	70															2.5	0.51	1.2	0.08		
1249.2	75															2.7	0.58	1.3	0.09		
1332.5	80															2.9	0.66	1.4	0.11		
1415.7	85															3.0	0.74	1.4	0.12		
1499.0	90															3.2	0.82	1.5	0.13	1.0	0.04
1665.6	100																	1.7	0.16	1.1	0.05
1832.1	110																	1.9	0.19	1.2	0.06
1998.7	120																	2.0	0.22	1.3	0.08
2165.3	130																	2.2	0.26	1.4	0.09
2331.8	140																	2.4	0.30	1.5	0.10
2498.4	150																	2.5	0.34	1.6	0.11

Notes: Shaded areas represent velocities over 1.5 m/s. Use with caution when water hammer is a concern.

FRICITION LOSS CHARTS - UPVC PIPE CLASS 5 (16 BAR)

C = 150 • PRESSURE LOSS (BAR/100 METRES)

Nominal Size		25 mm		32 mm		40 mm		50 mm		63 mm		75 mm		90 mm		110 mm		160 mm		200 mm	
Pipe ID		21.2 mm		27.2 mm		34 mm		42.6 mm		53.6 mm		63.8 mm		76.6 mm		93.6 mm		136.2 mm		170.2 mm	
Pipe OD		25 mm		32 mm		40 mm		50 mm		63 mm		75 mm		90 mm		110 mm		160 mm		200 mm	
Wall Thick		1.5 mm		1.8 mm		1.9 mm		2.4 mm		3 mm		3.6 mm		4.3 mm		5.3 mm		7.7 mm		14.9 mm	
Flow l/min	Flow m ³ /hr	Velocity m/s	bar loss	Velocity m/s	bar loss	Velocity m/s	bar loss	Velocity m/s	bar loss	Velocity m/s	bar loss	Velocity m/s	bar loss	Velocity m/s	bar loss	Velocity m/s	bar loss	Velocity m/s	bar loss	Velocity m/s	bar loss
3.8	0.25	0.2	0.03																		
7.6	0.5	0.4	0.10																		
11.4	0.75	0.6	0.21	0.4	0.06																
15.1	1	0.8	0.36	0.5	0.11	0.3	0.04														
26.5	1.5	1.2	0.77	0.7	0.23	0.5	0.08	0.3	0.03												
34.1	2	1.6	1.32	1.0	0.39	0.6	0.13	0.4	0.04												
41.6	2.5	2.0	1.99	1.2	0.59	0.8	0.20	0.5	0.07												
49.2	3	2.4	2.79	1.4	0.83	0.9	0.28	0.6	0.09												
56.8	3.5			1.7	1.10	1.1	0.37	0.7	0.12												
68.1	4			1.9	1.41	1.2	0.48	0.8	0.16												
83.3	5			2.4	2.13	1.5	0.72	1.0	0.24												
98.4	6					1.8	1.01	1.2	0.34	0.7	0.11										
117.3	7					2.1	1.34	1.4	0.45	0.9	0.15										
132.5	8					2.4	1.72	1.6	0.57	1.0	0.19										
151.4	9							1.8	0.71	1.1	0.23										
166.6	10							1.9	0.87	1.2	0.28										
181.7	11							2.1	1.03	1.4	0.34	1.0	0.14								
200.6	12							2.3	1.21	1.5	0.40	1.0	0.17								
215.8	13									1.6	0.46	1.1	0.20								
234.7	14									1.7	0.53	1.2	0.23								
249.8	15									1.8	0.60	1.3	0.26								
265.0	16									2.0	0.68	1.4	0.29	1.0	0.12						
283.9	17									2.1	0.76	1.5	0.32	1.0	0.13						
299.0	18									2.2	0.84	1.6	0.36	1.1	0.15						
318.0	19									2.3	0.93	1.7	0.40	1.1	0.16						
333.1	20									2.5	1.02	1.7	0.44	1.2	0.18						
348.3	21											1.8	0.48	1.3	0.20						
367.2	22											1.9	0.52	1.3	0.21						
382.3	23											2.0	0.57	1.4	0.23						
401.3	24											2.1	0.61	1.4	0.25	1.0	0.09				
416.4	25											2.2	0.66	1.5	0.27	1.0	0.10				
431.5	26											2.3	0.71	1.6	0.29	1.0	0.11				
450.5	27											2.3	0.76	1.6	0.31	1.1	0.12				
465.6	28											2.4	0.82	1.7	0.33	1.1	0.13				
484.5	29											2.5	0.87	1.7	0.36	1.2	0.13				
499.7	30													1.8	0.38	1.2	0.14				
583.0	35													2.1	0.51	1.4	0.19				
666.2	40													2.4	0.65	1.6	0.24				
749.5	45													2.7	0.81	1.8	0.30				
832.8	50															2.0	0.37	1.0	0.06		
916.1	55															2.2	0.44	1.0	0.07		
999.3	60															2.4	0.52	1.1	0.08		
1082.6	65															2.6	0.60	1.2	0.10		
1165.9	70															2.8	0.69	1.3	0.11		
1249.2	75															3.0	0.78	1.4	0.13		
1332.5	80															3.2	0.88	1.5	0.14		
1415.7	85																	1.6	0.16		
1499.0	90																	1.7	0.18		
1665.6	100																	1.9	0.21	1.2	0.07
1832.1	110																	2.1	0.26	1.3	0.09
1998.7	120																	2.3	0.30	1.5	0.10
2165.3	130																	2.5	0.35	1.6	0.12
2331.8	140																	2.7	0.40	1.7	0.14
2498.4	150																	2.9	0.45	1.8	0.15

Notes: Shaded areas represent velocities over 1.5 m/s. Use with caution when water hammer is a concern.

FRICITION LOSS CHARTS - SCHEDULE 40 IPS PVC PLASTIC PIPE

C = 150 • PRESSURE LOSS (BAR/100 METRES)																			
Nominal Size		1"		1¼"		1½"		2"		2½"		3"		4"		6"		8"	
Pipe OD		1.315"		1.66"		1.900"		2.375"		2.375"		3.500"		4.500"		6.625"		8.625"	
Pipe ID		1.049"		1.380"		1.610"		2.067"		2.469"		3.068"		4.026"		6.065"		7.981"	
Pipe ID mm		26.64		35.05		40.89		52.50		62.71		77.93		102.26		154.05		202.72	
Wall Thick		0.133"		0.140"		0.145"		0.154"		0.203"		0.216"		0.237"		0.280"		0.322"	
Flow l/min	Flow m³/hr	Velocity m/s	bar loss	Velocity m/s	bar loss	Velocity m/s	bar loss	Velocity m/s	bar loss	Velocity m/s	bar loss	Velocity m/s	bar loss	Velocity m/s	bar loss	Velocity m/s	bar loss	Velocity m/s	bar loss
3.8	0.25	0.1	0.01																
7.6	0.5	0.2	0.03																
11.4	0.75	0.4	0.07	0.2	0.02														
15.1	1	0.5	0.12	0.3	0.03	0.2	0.01												
26.5	1.5	0.7	0.25	0.4	0.07	0.3	0.03	0.2	0.01										
34.1	2	1.0	0.43	0.6	0.11	0.4	0.05	0.3	0.02										
41.6	2.5	1.2	0.65	0.7	0.17	0.5	0.08	0.3	0.02										
49.2	3	1.5	0.92	0.9	0.24	0.6	0.11	0.4	0.03										
56.8	3.5	1.7	1.22	1.0	0.32	0.7	0.15	0.4	0.04										
68.1	4	2.0	1.56	1.2	0.41	0.8	0.19	0.5	0.06										
83.3	5	2.5	2.36	1.4	0.62	1.1	0.29	0.6	0.09										
98.4	6			1.7	0.87	1.3	0.41	0.8	0.12	0.5	0.05	0.3	0.02						
117.3	7			2.0	1.16	1.5	0.55	0.9	0.16	0.6	0.07	0.4	0.02						
132.5	8			2.3	1.48	1.7	0.70	1.0	0.21	0.7	0.09	0.5	0.03						
151.4	9			2.6	1.84	1.9	0.87	1.2	0.26	0.8	0.11	0.5	0.04						
166.6	10			2.9	2.24	2.1	1.06	1.3	0.31	0.9	0.13	0.6	0.05						
181.7	11					2.3	1.26	1.4	0.37	1.0	0.16	0.6	0.05						
200.6	12					2.5	1.48	1.5	0.44	1.1	0.18	0.7	0.06						
215.8	13					2.7	1.72	1.7	0.51	1.2	0.21	0.8	0.07						
234.7	14					3.0	1.97	1.8	0.58	1.3	0.25	0.8	0.09						
249.8	15					3.2	2.24	1.9	0.66	1.3	0.28	0.9	0.10						
265.0	16							2.1	0.75	1.4	0.31	0.9	0.11						
283.9	17							2.2	0.84	1.5	0.35	1.0	0.12						
299.0	18							2.3	0.93	1.6	0.39	1.0	0.14						
318.0	19							2.4	1.03	1.7	0.43	1.1	0.15						
333.1	20							2.6	1.13	1.8	0.48	1.2	0.17						
348.3	21									1.9	0.52	1.2	0.18						
367.2	22									2.0	0.57	1.3	0.20						
382.3	23									2.1	0.62	1.3	0.21						
401.3	24									2.2	0.67	1.4	0.23						
416.4	25									2.2	0.72	1.5	0.25						
431.5	26									2.3	0.77	1.5	0.27						
450.5	27									2.4	0.83	1.6	0.29						
465.6	28											1.6	0.31						
484.5	29											1.7	0.33						
499.7	30											1.7	0.35						
583.0	35											2.0	0.47	1.2	0.12				
666.2	40											2.3	0.60	1.4	0.16				
749.5	45											2.6	0.74	1.5	0.20				
832.8	50											2.9	0.90	1.7	0.24				
916.1	55													1.9	0.29				
999.3	60													2.0	0.34				
1082.6	65													2.2	0.39	1.0	0.07		
1165.9	70													2.4	0.45	1.0	0.08		
1249.2	75													2.5	0.51	1.1	0.09		
1332.5	80													2.7	0.57	1.2	0.10		
1415.7	85													2.9	0.64	1.3	0.11		
1499.0	90													3.0	0.71	1.3	0.12	0.8	0.03
1665.6	100															1.5	0.15	0.9	0.03
1832.1	110															1.6	0.18	0.9	0.04
1998.7	120															1.8	0.21	1.0	0.04
2165.3	130															1.9	0.25	1.1	0.05
2331.8	140															2.1	0.28	1.2	0.06
2498.4	150															2.1	0.32	1.3	0.07

Notes: Shaded areas represent velocities over 1.5 m/s. Use with caution when water hammer is a concern.

FRICION LOSS CHARTS - SCHEDULE 80 IPS PVC PLASTIC PIPE

C = 150 • PRESSURE LOSS (BAR/100 METRES)

Nominal Size		1"		1¼"		1½"		2"		2½"		3"		4"		6"		8"	
Pipe OD		1.315"		1.660"		1.900"		2.375"		2.875"		3.500"		4.500"		6.625"		8.625"	
Pipe ID		0.957"		1.278"		1.500"		1.939"		2.323"		2.900"		3.826"		5.761"		7.625"	
Pipe ID mm		24.31		32.46		38.10		49.25		59.00		73.66		97.18		146.33		193.68	
Wall Thick		0.179"		0.191"		0.200"		0.218"		0.276"		0.300"		0.337"		0.432"		0.500"	
Flow l/min	Flow m³/hr	Velocity m/s	bar loss	Velocity m/s	bar loss	Velocity m/s	bar loss	Velocity m/s	bar loss	Velocity m/s	bar loss	Velocity m/s	bar loss	Velocity m/s	bar loss	Velocity m/s	bar loss	Velocity m/s	bar loss
3.8	0.25	0.1	0.01																
7.6	0.5	0.3	0.05																
11.4	0.75	0.4	0.11	0.3	0.03														
15.1	1	0.6	0.19	0.3	0.05	0.2	0.02												
26.5	1.5	0.9	0.40	0.5	0.10	0.4	0.04	0.2	0.01										
34.1	2	1.2	0.68	0.7	0.17	0.5	0.08	0.3	0.02										
41.6	2.5	1.5	1.02	0.8	0.25	0.6	0.11	0.4	0.03										
49.2	3	1.8	1.43	1.0	0.35	0.7	0.16	0.4	0.05										
56.8	3.5	2.1	1.90	1.2	0.47	0.9	0.21	0.5	0.06										
68.1	4	2.4	2.44	1.3	0.60	1.0	0.27	0.6	0.08										
83.3	5	3.0	3.69	1.7	0.90	1.2	0.41	0.7	0.12										
98.4	6			2.0	1.26	1.5	0.58	0.9	0.17	0.6	0.07	0.4	0.02						
117.3	7			2.3	1.68	1.7	0.77	1.0	0.22	0.7	0.09	0.5	0.03						
132.5	8			2.7	2.15	1.9	0.99	1.2	0.28	0.8	0.12	0.5	0.04						
151.4	9			3.0	2.68	2.2	1.23	1.3	0.35	0.9	0.15	0.6	0.05						
166.6	10					2.4	1.49	1.5	0.43	1.0	0.18	0.7	0.06						
181.7	11					2.7	1.78	1.6	0.51	1.1	0.21	0.7	0.07						
200.6	12					2.9	2.09	1.7	0.60	1.2	0.25	0.8	0.08						
215.8	13							1.9	0.69	1.3	0.29	0.8	0.10						
234.7	14							2.0	0.80	1.4	0.33	0.9	0.11						
249.8	15							2.2	0.91	1.5	0.38	1.0	0.13						
265.0	16							2.3	1.02	1.6	0.42	1.0	0.14						
283.9	17							2.5	1.14	1.7	0.47	1.1	0.16						
299.0	18							2.6	1.27	1.8	0.53	1.2	0.18						
318.0	19									1.9	0.58	1.2	0.20						
333.1	20									2.0	0.64	1.3	0.22						
348.3	21									2.1	0.70	1.4	0.24						
367.2	22									2.2	0.76	1.4	0.26						
382.3	23									2.3	0.83	1.5	0.28						
401.3	24									2.4	0.90	1.6	0.30						
416.4	25									2.5	0.97	1.6	0.33						
431.5	26											1.7	0.35						
450.5	27											1.8	0.38						
465.6	28											1.8	0.41	1.0	0.11				
484.5	29											1.9	0.43	1.1	0.11				
499.7	30											2.0	0.46	1.1	0.12				
583.0	35											2.3	0.61	1.3	0.16				
666.2	40											2.6	0.78	1.5	0.20				
749.5	45													1.7	0.25				
832.8	50													1.9	0.31				
916.1	55													2.1	0.37				
999.3	60													2.2	0.43				
1082.6	65													2.4	0.50	1.1	0.07		
1165.9	70													2.6	0.57	1.2	0.08		
1249.2	75													2.8	0.65	1.2	0.09		
1332.5	80													3.0	0.73	1.3	0.10		
1415.7	85													3.2	0.82	1.4	0.11		
1499.0	90													3.4	0.91	1.5	0.12		
1665.6	100															1.7	0.15	0.9	0.04
1832.1	110															1.8	0.18	1.0	0.05
1998.7	120															2.0	0.21	1.1	0.05
2165.3	130															2.1	0.25	1.2	0.06
2331.8	140															2.3	0.28	1.3	0.07
2498.4	150															2.5	0.32	1.4	0.08

Notes: Shaded areas represent velocities over 1.5 m/s. Use with caution when water hammer is a concern.

FRICION LOSS CHARTS - HDPE PRESSURE PIPE PE80 SDR 17.6 PN6

C = 140 • PRESSURE LOSS (BAR/100 METRES)																						
Nominal Size Pipe ID mm Wall Thick		25 mm 21.40 1.8		32 mm 28.40 1.8		40 mm 35.40 2.3		50 mm 44.20 2.9		63 mm 55.80 3.6		75 mm 66.40 4.3		90 mm 79.80 5.1		110 mm 97.40 6.3		160 mm 141.80 9.1		200 mm 177.20 11.4		
Flow l/min	Flow m ³ /hr	Velocity m/s	bar loss	Velocity m/s	bar loss	Velocity m/s	bar loss	Velocity m/s	bar loss	Velocity m/s	bar loss	Velocity m/s	bar loss	Velocity m/s	bar loss	Velocity m/s	bar loss	Velocity m/s	bar loss	Velocity m/s	bar loss	
3.8	0.25	0.2	0.03																			
7.6	0.5	0.4	0.11																			
11.4	0.75	0.6	0.23	0.3	0.06																	
15.1	1	0.8	0.40	0.4	0.10	0.3	0.03															
26.5	1.5	1.2	0.84	0.7	0.21	0.4	0.07	0.3	0.02													
34.1	2	1.5	1.43	0.9	0.36	0.6	0.12	0.4	0.04													
41.6	2.5	1.9	2.16	1.1	0.54	0.7	0.19	0.5	0.06													
49.2	3	2.3	3.03	1.3	0.76	0.8	0.26	0.5	0.09													
56.8	3.5	2.7	4.03	1.5	1.01	1.0	0.35	0.6	0.12													
68.1	4	3.1	5.16	1.8	1.30	1.1	0.44	0.7	0.15													
83.3	5			2.2	1.96	1.4	0.67	0.9	0.23													
98.4	6			2.6	2.75	1.7	0.94	1.1	0.32	0.7	0.10	0.5	0.04									
117.3	7			3.1	3.66	2.0	1.25	1.3	0.42	0.8	0.14	0.6	0.06									
132.5	8			3.5	4.69	2.3	1.60	1.4	0.54	0.9	0.17	0.6	0.07									
151.4	9					2.5	2.00	1.6	0.68	1.0	0.22	0.7	0.09									
166.6	10					2.8	2.43	1.8	0.82	1.1	0.26	0.8	0.11									
181.7	11							2.0	0.98	1.2	0.32	0.9	0.14									
200.6	12							2.2	1.15	1.4	0.37	1.0	0.16									
215.8	13							2.4	1.34	1.5	0.43	1.0	0.18									
234.7	14							2.5	1.53	1.6	0.49	1.1	0.21									
249.8	15							2.7	1.74	1.7	0.56	1.2	0.24									
265.0	16							2.9	1.96	1.8	0.63	1.3	0.27									
283.9	17							3.1	2.20	1.9	0.71	1.4	0.30									
299.0	18							3.3	2.44	2.0	0.79	1.4	0.34									
318.0	19									2.2	0.87	1.5	0.37									
333.1	20									2.3	0.95	1.6	0.41									
348.3	21									2.4	1.04	1.7	0.45	1.2	0.18							
367.2	22									2.5	1.14	1.8	0.49	1.2	0.20							
382.3	23									2.6	1.24	1.8	0.53	1.3	0.22							
401.3	24									2.7	1.34	1.9	0.57	1.3	0.23							
416.4	25									3.8	1.44	2.0	0.62	1.4	0.25							
431.5	26											2.1	0.67	1.4	0.27	1.0	0.10	0.5	0.02			
450.5	27											2.2	0.71	1.5	0.29	1.0	0.11	0.5	0.02			
465.6	28											2.2	0.76	1.6	0.31	1.0	0.12	0.5	0.02			
484.5	29											2.3	0.81	1.6	0.33	1.1	0.13	0.5	0.02			
499.7	30											2.4	0.87	1.7	0.35	1.1	0.13	0.5	0.02			
583.0	35											2.8	1.15	1.9	0.47	1.3	0.18	0.6	0.03			
666.2	40											3.2	1.48	2.2	0.60	1.5	0.23	0.7	0.04			
749.5	45													2.5	0.75	1.7	0.28	0.8	0.05			
832.8	50													2.8	0.91	1.9	0.35	0.9	0.06			
916.1	55													3.1	1.09	2.1	0.41	1.0	0.07			
999.3	60													3.3	1.28	2.2	0.48	1.1	0.08			
1082.6	65															2.4	0.56	1.1	0.09			
1165.9	70															2.6	0.64	1.2	0.10			
1249.2	75																	1.3	0.12			
1332.5	80																	1.4	0.13			
1415.7	85																	1.5	0.15			
1499.0	90																	1.6	0.16			
1665.6	100																	1.8	0.20	1.1	0.07	
1832.1	110																	1.9	0.24	1.2	0.08	
1998.7	120																	2.1	0.28	1.4	0.09	
2165.3	130																	2.3	0.33	1.5	0.11	
2331.8	140																			1.6	0.13	
2498.4	150																			1.7	0.14	

Notes: Shaded areas represent velocities over 1.5 m/s. Use with caution when water hammer is a concern.

FRICION LOSS CHARTS - HDPE PRESSURE PIPE PE80 SDR 11 PN10

C = 140 • PRESSURE LOSS (BAR/100 METRES)

Nominal Size Pipe ID mm Wall Thick		25 mm 20.40 2.3		32 mm 26.20 2.9		40 mm 32.60 3.7		50 mm 40.80 4.6		63 mm 51.40 5.8		75 mm 61.40 6.8		90 mm 73.60 8.2		110 mm 90.00 10		160 mm 130.80 14.6		200 mm 163.60 18.2	
Flow l/min	Flow m ³ /hr	Velocity m/s	bar loss	Velocity m/s	bar loss	Velocity m/s	bar loss	Velocity m/s	bar loss	Velocity m/s	bar loss	Velocity m/s	bar loss	Velocity m/s	bar loss	Velocity m/s	bar loss	Velocity m/s	bar loss	Velocity m/s	bar loss
3.8	0.25	0.2	0.04																		
7.6	0.5	0.4	0.14																		
11.4	0.75	0.6	0.29	0.4	0.09																
15.1	1	0.8	0.50	0.5	0.15																
26.5	1.5	1.3	1.06	0.8	0.31	0.5	0.11														
34.1	2	1.7	1.80	1.0	0.53	0.7	0.18														
41.6	2.5	2.1	2.73	1.3	0.81	0.8	0.28	0.5	0.09												
49.2	3	2.5	3.82	1.5	1.13	1.0	0.39	0.6	0.13												
56.8	3.5	3.0	5.08	1.8	1.50	1.2	0.52	0.7	0.17												
68.1	4			2.1	1.92	1.3	0.66	0.8	0.22	0.5	0.07										
83.3	5			2.6	2.91	1.7	1.00	1.1	0.34	0.7	0.11										
98.4	6			3.1	4.08	2.0	1.41	1.3	0.47	0.8	0.15										
117.3	7					2.3	1.87	1.5	0.63	0.9	0.20										
132.5	8					2.7	2.40	1.7	0.8	1.1	0.26										
151.4	9					3.0	2.98	1.9	1.00	1.2	0.32										
166.6	10							2.1	1.21	1.3	0.39										
181.7	11							2.3	1.45	1.5	0.47	1.0	0.20								
200.6	12							2.5	1.70	1.6	0.55	1.1	0.23								
215.8	13							2.8	1.97	1.7	0.64	1.2	0.27								
234.7	14							3.0	2.27	1.9	0.74	1.3	0.31								
249.8	15									2.0	0.84	1.4	0.35								
265.0	16									2.1	0.94	1.5	0.40								
283.9	17									2.3	1.05	1.6	0.44	1.1	0.18						
299.0	18									2.4	1.17	1.7	0.49	1.2	0.20						
318.0	19									2.5	1.30	1.8	0.54	1.2	0.23						
333.1	20									2.7	1.42	1.9	0.60	1.3	0.25						
348.3	21									2.8	1.56	2.0	0.66	1.4	0.27						
367.2	22									2.9	1.70	2.1	0.71	1.4	0.30						
382.3	23									3.1	1.84	2.2	0.78	1.5	0.32						
401.3	24											2.3	0.84	1.6	0.35						
416.4	25											2.3	0.91	1.6	0.37						
431.5	26											2.4	0.97	1.7	0.40	1.1	0.15				
450.5	27											2.5	1.04	1.8	0.43	1.2	0.16				
465.6	28											2.6	1.12	1.8	0.46	1.2	0.17				
484.5	29											2.7	1.19	1.9	0.49	1.3	0.19				
499.7	30											2.8	1.27	2.0	0.53	1.3	0.20				
583.0	35											3.3	1.69	2.3	0.70	1.5	0.26				
666.2	40													2.6	0.89	1.7	0.34				
749.5	45													2.9	1.11	2.0	0.42				
832.8	50													3.3	1.35	2.2	0.51	1.0	0.08		
916.1	55															2.4	0.61	1.1	0.10		
999.3	60															2.6	0.71	1.2	0.12		
1082.6	65															2.8	0.83	1.3	0.13		
1165.9	70															3.1	0.95	1.4	0.15		
1249.2	75															3.3	1.08	1.6	0.17		
1332.5	80																	1.7	0.20		
1415.7	85																	1.8	0.22	1.1	0.07
1499.0	90																	1.9	0.24	1.2	0.08
1665.6	100																	2.1	0.30	1.3	0.10
1832.1	110																	2.3	0.35	1.5	0.12
1998.7	120																	2.5	0.42	1.6	0.14
2165.3	130																	2.7	0.48	1.7	0.16
2331.8	140																			1.8	0.19
2498.4	150																			2.0	0.21

Notes: Shaded areas represent velocities over 1.5 m/s. Use with caution when water hammer is a concern.

PRESSURE LOSS CHARTS

TABLE OF APPROXIMATE PRESSURE LOSSES FOR PIPE FITTINGS

Steel Fitting Type	½"	¾"	1" (25 mm)	1¼" (30 mm)	1½" (40 mm)	2" (50 mm)	2½" (65 mm)	3" (80 mm)	4" (100 mm)	6" (150 mm)	8" (200 mm)
Coupling	0.18	0.24	0.30	0.37	0.46	0.61	0.76	0.91	1.21	1.82	2.40
Run of St. Tee	0.30	0.30	4.60	0.60	0.60	0.76	0.91	1.21	1.52	2.13	3.05
Tee, Side Outlet	0.91	1.38	1.50	2.13	2.74	3.35	4.0	4.90	6.1	9.44	12.1
Tee, Run Reduced ½"	0.45	0.76	0.91	1.21	1.50	1.82	2.13	2.4	3.65	4.90	6.10
Elbow, 90°	0.45	0.76	0.91	1.21	1.50	1.82	2.13	2.4	3.65	4.90	6.10
Elbow, 45°	0.22	0.30	0.40	0.52	0.60	0.76	0.91	1.06	1.5	2.28	3.04
Corporation Stop	2.74	2.74	2.74	2.74	2.74	2.74					
Curb Stop	1.82	1.82	2.13	2.13	2.43	2.43					

Plastic IPS or Copper Fitting Type	½"	¾"	1" (25 mm)	1¼" (30 mm)	1½" (40 mm)	2" (50 mm)	2½" (65 mm)	3" (80 mm)	4" (100 mm)	6" (150 mm)	8" (200 mm)
Coupling	0.46	0.76	0.91	0.91	1.22	1.82	2.13	2.43	3.35	5.50	7.31
Run of St. Tee	0.76	0.91	1.22	1.52	1.83	2.43	2.74	3.35	4.57	6.40	8.53
Tee, Side Outlet	2.13	2.74	3.65	4.57	5.48	7.31	9.14	11.0	13.71	21.33	27.43
Tee, Run Reduced ½"	1.06	1.37	1.82	2.43	2.74	3.35	4.26	5.18	7.31	10.36	13.71
Elbow, 90°	1.06	1.37	1.82	2.43	2.74	3.35	4.26	5.18	7.31	10.36	13.71
Elbow, 34°	0.46	0.60	0.91	1.06	1.22	1.52	2.13	2.44	3.04	4.90	6.10

Note:

It is recommended that the charts above only be used when the manufacturer's recommended pressure loss values are not available.

ACCESSORY PRESSURE LOSS CHARTS

HCV PRESSURE LOSS CHART

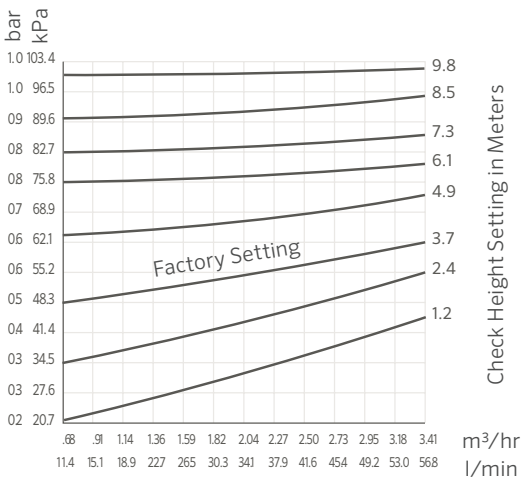

SWING JOINT FRICTION LOSS

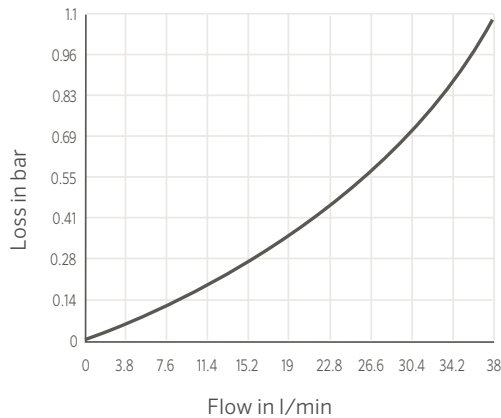

PRESSURE LOSS CHARTS

**BTT 1-ZONE Inlet Size 3/4",
Flow Rate 3-27 l/min**

l/min	Friction Loss
3	0.3 (28)
7	0.3 (34)
11	0.4 (41)
15	0.6 (55)
19	0.8 (76)
23	1 (103)
27	1 (138)

Note:

Maximum flow at 3.4 bar (340kPa)

**BTT 2-ZONE Inlet Size 3/4",
Flow Rate 3-27 l/min**

l/min	Friction Loss
3	0.1 (14)
7	0.2 (21)
11	0.3 (34)
15	0.5 (48)
19	0.7 (69)
23	1 (69)
27	1 (124)

Note:

Maximum flow at 3.4 bar (340kPa)
Data shows one 1-zone running at a time.

For applications requiring higher efficiency and lower friction loss, use Hunter valves and dripline products.

WIRE DATA

STANDARD ANNEALED COPPER AT 20°C						
American Wire Gauge	Common Metric Equivalent (mm ²)	Diameter (mils)	Diameter (mm)	Cross-Sectional Area (mm ²)	Resistance (Per mft ohms)	Resistance (per km ohms)
1	50	289.3	7.348	42.4	0.924	0.407
2	35	257.6	6.543	33.6	0.156	0.513
3		229.4	5.827	26.7	0.197	0.647
4	25	204.3	5.189	21.1	0.249	0.815
5		181.9	4.62	16.8	0.313	1.028
6	16	162	4.115	13.3	0.395	1.297
7		144.3	3.665	10.6	0.498	1.634
8	10	128.5	3.264	8.36	0.628	2.061
9		114.4	2.906	6.63	0.793	2.6
10	6	101.9	2.588	5.26	0.999	3.277
11		90.7	2.3	4.17	1.26	4.14
12	4	80.8	2.05	3.31	1.59	5.21
13		72	1.83	2.63	2	6.56
14	2.5	64.1	1.63	1.63	2.52	8.28
15		57.1	1.45	1.65	3.18	10.4
16	1.5	50.8	1.29	1.31	4.02	13.2
17		45.3	1.15	1.04	5.05	16.6
18	0.75	40.3	1.02	0.82	6.39	21
19		35.9	0.912	0.65	8.05	26.4
20	0.5	32	0.813	0.52	10.1	33.2

PSR WIRE DATA

MAXIMUM WIRE LENGTH, ONE WAY						
Model	0.75 mm ²	1.5 mm ²	2.5 mm ²	4 mm ²	6 mm ²	10 mm ²
PSR-22	74 m	118 m	188 m	298 m	473 m	751 m
PSR-52	41 m	65 m	104 m	165 m	262 m	416 m
PSR-53	41 m	65 m	104 m	165 m	262 m	416 m

WIRE SIZING

REQUIRED INFORMATION

- 1) Actual one-way length of wire between the controllers and the power source or the controllers and valves
- 2) Allowable voltage loss along the wire circuit
- 3) Accumulative current flowing through the wire section being sized in amperes

RESISTANCE IS CALCULATED USING THIS FORMULA:

$$R = \frac{1,000 \times AVL}{2L \times I}$$

R = Maximum allowable resistance of wire in ohms per 1,000 m

AVL = Allowable voltage loss

L = Wire length (one way)

I = Inrush current

AVL for controller power wire sizing is calculated by subtracting the minimum operating voltage required by the controller from the minimum available voltage at the power source.

AVL for valve wire sizing is calculated by subtracting minimum solenoid operating voltage from controller output voltage.

This number will vary depending on the manufacturer and in some cases with line pressure.

VALVE WIRE SIZING EXAMPLE

Given: The distance from the controller to the valve is 600 m. The controller output is 24 V. The valve has a minimum operating voltage of 20 V and an inrush current of 370 mA (0.37 A).

$$R = \frac{1,000 \times 4}{2(600) \times 0.37}$$

$$R = \frac{4,000}{444}$$

$$R = 9.01 \text{ ohms}/1,000 \text{ m}$$

So, wire resistance cannot exceed 9 ohms per 1,000 m. Now go to table #1 and select the proper wire size. Since 1.5 mm² gauge wire has more resistance than 9 ohms per 1,000 m, choose 2.5 mm² wire.

Table 2 is a quick reference and is set up to provide maximum wire runs given the information at the bottom of the table.

TABLE 1 - RESISTANCE OF COPPER WIRE		TABLE 2 - ALLOWABLE DISTANCES FOR VARIOUS WIRE SIZES*						
Wire Size (mm ²)	Resistance in Ohms per 1,000 m at 20° C	Ground Wire (mm ²)	0.5	1.0	Control Wire (mm ²)			
					1.5	2.5	4.0	6.0
0.5	34.5	0.5	157	209	235	261	279	289
1.0	17.2	1.0	209	314	377	449	503	538
1.5	11.5	1.5	235	377	470	588	684	754
2.5	6.9	2.5	261	449	588	783	965	1103
4.0	4.3	4.0	279	503	684	965	1,257	1,502
6.0	2.9	6.0	289	538	751	1,103	1,502	1,864

Notes:

Maximum one-way distance in metres between controller and solenoid assuming 370 mA inrush current, AVL = 4 volts, 1 valve on at a time

Table 2 is for a single active solenoid. With two solenoids operating simultaneously on the same wires, the wire distances should be halved.

ADDITIONAL DATA

WIRE SIZE REFERENCE CHART

Wire Size (mm ²)	25 mm	32 mm	40 mm	50 mm	63 mm	75 mm	90 mm	110 mm	160 mm	Wire Size (mm ²)
0.5	20	35	49	80	110	175	-	-	-	0.5
1	16	30	42	67	97	150	-	-	-	1
1.5	10	18	25	40	56	88	120	150	-	1.5
2.5	7	15	20	33	50	75	102	130	-	2.5
4	6	13	16	27	40	63	85	110	-	4
6	4	6	9	16	25	35	50	65	150	6

Notes:

Approximate number of wires to be installed in conduit or tubing. Maximum number of wires in conduit or sleeving.

CLIMATE E_{Tp} TABLE

Climate*	mm Daily
Cool Humid	2.5 to 3.8
Cool Dry	3.8 to 5.1
Warm Humid	3.8 to 5.1
Warm Dry	5.1 to 6.3
Hot Humid	5.1 to 7.6
Hot Dry	7.6 to 11.4

Notes:

- * Cool = under 21°C as an average midsummer high
- * Warm = between 21° and 32°C as midsummer highs
- * Hot = over 32°C
- * Humid = over 50% as average midsummer relative humidity (dry = under 50%)

NOTES

A large grid of graph paper for taking notes, consisting of a uniform pattern of light blue lines forming small squares across the page.

TECHNICAL INFORMATION



STATEMENT OF WARRANTY

Hunter Residential and Commercial Irrigation Products

Hunter Industries Incorporated (“Hunter”) warrants the following products to be free of defects in materials or workmanship under normal use in landscape irrigation applications for the specified period of time outlined below from the original date of manufacture:

ONE YEAR	ROTORS	SRM	MICRO	Micro Sprays, PLD Fittings, Rigid Risers, Air Relief Valves
	ROTORS	PGP-ADJ, PGJ, HCV	CONTROLLERS	ACC (Legacy), BTT, Eco Logic, FS-1000, FS-3000, I-Core/DUAL (Legacy), NODE, NODE-BT, Pro-C, PSR, ROAM, X-Core, XC Hybrid, and Hydrowise Controllers (HC, X2, WAND, PHC, HPC, HCC)
TWO YEARS	SPRAYS	PS Ultra, SJ, FlexSG, HSBE	SENSORS	HC Flow Meter (wired and wireless)
	NOZZLES	Spray Nozzles, PCN, PCB, AFB, MSBN	MICRO	PCZ, RZWS, Point-Source Emitters, Tubing, Multi-Port Emitters, IH Risers, MLD, Eco-Indicator***, Multi-Purpose Box, Senninger Regulators, PLD-LOC Fittings
	VALVES	PGV	TOOLS	SpotShot
	CENTRAL****	All communication modules (Cell, LAN, Wi-Fi) for ACC, ACC2, ICC2, and other Centralus controllers.		
THREE YEARS	CONTROLLERS	ROAM XL, EZ Decoder System, EZ-DT	MP ROTATOR	All
	ROTORS	PGP Ultra, I-20, I-25, I-40, I-80, and I-90	CONTROLLERS	ACC2, ICC2, ICD Decoders, ICD-HP Programmer
FIVE YEARS	SPRAYS	Pro-Spray, Pro-Spray PRS30, and Pro-Spray PRS40	SENSORS	Clik Sensors, Flow-Sync, MWS, Solar Sync, Wireless Flow Sensor
	VALVES	HQ, ICV, IBV	MICRO	PLD, HDL**, HDL-COP** Eco-Mat, Eco-Wrap, Eco-Indicator***

Hunter Golf and ST System Irrigation Products*

Hunter will unconditionally repair, replace, or repurchase, at its sole discretion, any defective component* assemblies contained within the Golf and ST products listed below by category, returned freight prepaid, from the date of manufacture within a period of:

ONE YEAR	GOLF CONTROLLERS	Pilot Command Center Software, Pilot-FC, Pilot-FI, Pilot Hub
THREE YEARS	GOLF ROTORS	TTS-800 Series, G-800 Series, G-900 Series, B Series
	GOLF TWO-WAY MODULES	Pilot 100, Pilot 200, Pilot 400, Pilot 600
FIVE YEARS	GOLF ROTORS	The golf rotor component warranty is extended to 5 years with a one-for-one purchase of an HSJ Swing Joint from an authorized Hunter Golf distributor.
	SWING JOINTS	HSJ-0, HSJ-1, HSJ-2, HSJ-3
	ST ROTORS	ST-90, STG-900, ST-1200, ST-1600, ST-1700
	ST ACCESSORIES	All models starting with “ST”
	COMPUTER, PRINTERS & ACCESSORIES, MAINTENANCE RADIO & BATTERY	Equipment manufacturer’s warranty (no Hunter warranty)



Built on Innovation®

* Warranty covers repair, replacement, or repurchase of individual defective component assemblies contained within the product. Returns of complete finished goods are not allowed under warranty without prior approval from the Hunter Product Manager.

If used for agricultural applications, Hunter limits the warranty for valves, sprays, MP Rotator Nozzles, and rotor products to a period of one (1) year from the original date of manufacture. This agriculture limitation supersedes all other warranties expressed or implied.

** Plus 2 additional years for environmental stress cracking. No warranty against root intrusion on HDL-COP. While the use of copper does not completely remove the chance of root intrusion, it has been shown to assist in its prevention when coupled with proper irrigation scheduling.

*** Eco-Indicator – 6" ECO-ID: 2-year warranty; 12" ECO-ID-12: 5-year warranty

**** Hunter's cellular module warranty does not apply to the availability or compatibility of cellular data service, in any particular area. Availability of compatible data services should be determined prior to installation.

Statement of Warranty, Continued

If a defect in a Hunter product is discovered during the applicable warranty period, Hunter will repair or replace, at its option, the product or the defective part. This warranty does not extend to repairs, adjustments, or replacement of a Hunter product or part that results from misuse, negligence, alteration, modification, tampering, or improper installation and/or maintenance of the product. This warranty extends only to the original installer of the Hunter product. If a defect arises in a Hunter product during the warranty period, contact your local Hunter Authorised Distributor.

Hunter's warranty applies only to products installed as specified and used as intended for irrigation purposes. Hunter's warranty shall be limited to defects in materials and workmanship during the warranty period, and shall not extend to situations in which the product was subjected to improper design, installation, operation, maintenance, application, abuse, improper electrical current, grounding, service other than by Hunter authorised agents, operating conditions other than that for which it was designed, or in systems using water containing corrosive chemicals, electrolytes, sand, dirt, silt, rust, or agents that otherwise attack and degrade plastics. Hunter's warranty does not cover component failures caused by lightning strikes, electrical power surges, or unconditioned power supplies. If products are repurchased, the price to Distributor for such products in effect at the time of return will apply.

Hunter's obligation to repair, replace, or repurchase its products or product components as set forth above is the sole and exclusive warranty extended by Hunter. There are no other warranties, expressed or implied, including warranties of merchantability and warranties of fitness for a particular purpose. Hunter will not be liable to a distributor or to any other party in strict liability, tort, contract, or any other manner for any damages caused or claimed to be caused as a result of any design of or defect in Hunter's products, or for any special, incidental, or consequential damages of any nature.

Where applicable, Hunter's statement of warranty complies with local directives.

If you have any questions concerning the warranty or its application, please email support@hunterindustries.com.

ASAE CERTIFICATION STATEMENT

Hunter Industries Incorporated certifies that pressure, flow rate, and radius data for these products were determined and listed in accordance with ASAE Standard S398.1, Procedure for Sprinkler Testing and Performance Reporting, and are representative of performance of production sprinklers at the time of publication. Actual product performance may differ from the published specifications due to normal manufacturing variations and sample selection. All other specifications are solely the recommendation of Hunter Industries Incorporated.



Helping our customers succeed is what drives us. While our passion for innovation and engineering is built into everything we do, it is our commitment to exceptional support that we hope will keep you in the Hunter family of customers for years to come.

Gregory R. Hunter, CEO of Hunter Industries

Denise Mullikin, President, Landscape Irrigation and Outdoor Lighting

Website hunterindustries.com | **Customer Support** +1-760-752-6037 | **Technical Service** +1-760-591-7383

USA HEADQUARTERS

1940 Diamond Street
San Marcos, CA 92078 USA
TEL: +1-760-744-5240

MEXICO

ISO 9001:2015 Certified
Calle Nordika #8615
Colonia la Joya
Parque Industrial Nordika
Tijuana, B.C., Mexico CP 22640
TEL: +011-52-664-903-1382

EUROPE

Avenida Diagonal 523, 5o-2a
Edificio Atalaya
08029 Barcelona, Spain
TEL: +34-9-34-94-88-81

AUSTRALIA

50 Lynch Street
Hawthorn, VIC 3122, Australia
TEL: +1-800-438-486 [1-800-GETHUNTER]
(in Australia)
TEL: +61-3-9562-9918 (outside Australia)

MIDDLE EAST

P.O. Box 2370
Amman, 11941, Jordan
TEL: +962-6-5152882
FAX: +962-6-5152992

CHINA

B1618, Huibin Plaza
No. 8, Beichen Dong Street
Beijing 100101, China
TEL/FAX: +86-10-84975146